



AC/DC Converter
Non-Isolation Buck Converter
PWM method 9 W 12 V
BM2P121X Reference Board

User's Guide

<High Voltage Safety Precautions>

◇ Read all safety precautions before use

Please note that this document covers only the BM2P121X evaluation board (BM2P121X-EVK-001) and its functions. For additional information, please refer to the datasheet.

To ensure safe operation, please carefully read all precautions before handling the evaluation board



Depending on the configuration of the board and voltages used,

Potentially lethal voltages may be generated.

Therefore, please make sure to read and observe all safety precautions described in the red box below.

Before Use

- [1] Verify that the parts/components are not damaged or missing (i.e. due to the drops).
- [2] Check that there are no conductive foreign objects on the board.
- [3] Be careful when performing soldering on the module and/or evaluation board to ensure that solder splash does not occur.
- [4] Check that there is no condensation or water droplets on the circuit board.

During Use

- [5] Be careful to not allow conductive objects to come into contact with the board.
- [6] **Brief accidental contact or even bringing your hand close to the board may result in discharge and lead to severe injury or death.**

Therefore, DO NOT touch the board with your bare hands or bring them too close to the board.

In addition, as mentioned above please exercise extreme caution when using conductive tools such as tweezers and screwdrivers.

- [7] If used under conditions beyond its rated voltage, it may cause defects such as short-circuit or, depending on the circumstances, explosion or other permanent damages.
- [8] Be sure to wear insulated gloves when handling is required during operation.

After Use

- [9] The ROHM Evaluation Board contains the circuits which store the high voltage. Since it stores the charges even after the connected power circuits are cut, please discharge the electricity after using it, and please deal with it after confirming such electric discharge.
- [10] Protect against electric shocks by wearing insulated gloves when handling.

This evaluation board is intended for use only in research and development facilities and should be handled **only by qualified personnel familiar with all safety and operating procedures.**

We recommend carrying out operation in a safe environment that includes the use of high voltage signage at all entrances, safety interlocks, and protective glasses.

AC/DC Converter Non-Isolation Buck Converter PWM method Output 9 W 12 V **BM2P121X Reference Board** BM2P121X-EVK-001

The BM2P121X-EVK-001 evaluation board outputs 12 V voltage from the input of 90 Vac to 264 Vac. The output current supplies up to 0.75 A. The BM2P121X which is PWM method DC/DC converter IC built-in 650 V MOSFET is used.

The BM2P121X contributes to low power consumption by built-in a 650 V starting circuit. Built-in current detection resistor realizes compact power supply design. Current mode control imposes current limitation on every cycle, providing superior performance in bandwidth and transient response. The switching frequency is 65 kHz in fixed mode. At light load, frequency is reduced and high efficiency is realized. Built-in frequency hopping function contributes to low EMI. Low on-resistance 1.5 Ω 650 V MOSFET built-in contributes to low power consumption and easy design.

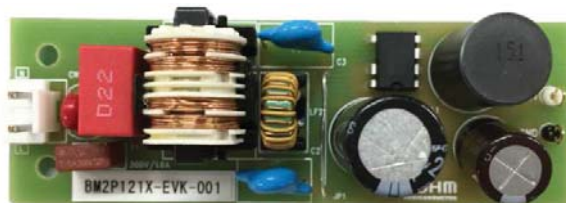

Figure 1. BM2P121X-EVK-001

Electronics Characteristics

Not guarantee the characteristics, is representative value.

Unless otherwise noted : $V_{IN} = 230 \text{ Vac}$, $I_{OUT} = 0.5 \text{ A}$, $T_a: 25 \text{ }^\circ\text{C}$

Parameter	Min	Typ	Max	Units	Conditions
Input Voltage Range	90	230	264	Vac	
Input Frequency	47	50/60	63	Hz	
Output Voltage	10.8	12.0	13.2	V	
Maximum Output Power	-	-	9.0	W	$I_{OUT} = 0.75 \text{ A}$
Output Current Range (NOTE1)	0.00	0.50	0.75	A	
Stand-by Power	-	140	-	mW	$I_{OUT} = 0 \text{ A}$
Efficiency	-	82.1	-	%	
Output Ripple Voltage (NOTE2)	-	61	-	mVpp	
Operating Temperature Range	-10	+25	+65	$^\circ\text{C}$	

(NOTE1) Please adjust operating time, within any parts surface temperature under 105 $^\circ\text{C}$

(NOTE2) Not include spike noise

Operation Procedure

1. Operation Equipment

- (1) AC Power supply 90 Vac~264 Vac, over 20W
- (2) Electronic Load capacity 0.75 A
- (3) Multi meter

2. Connect method

- (1) AC power supply presetting range 90~264 Vac, Output switch is off.
- (2) Load setting under 0.75 A. Load switch is off.
- (3) AC power supply N terminal connect to the board AC (N) of CN1, and L terminal connect to AC(L).
- (4) Load + terminal connect to VOUT, GND terminal connect to GND terminal
- (5) AC power meter connect between AC power supply and board.
- (6) Output test equipment connects to output terminal
- (7) AC power supply switch ON.
- (8) Check that output voltage is 12 V.
- (9) Electronic load switch ON
- (10) Check output voltage drop by load connect wire resistance



CN1 : from the top ①:AC (L), ②:AC (N)

Figure 2. Connection Circuit

Deleting

Maximum Output Power P_o of this reference board is 9.0 W. The derating curve is shown on the right. If ambient temperature is over 40°C, Please adjust load continuous time by over 105 °C of any parts surface temperature.

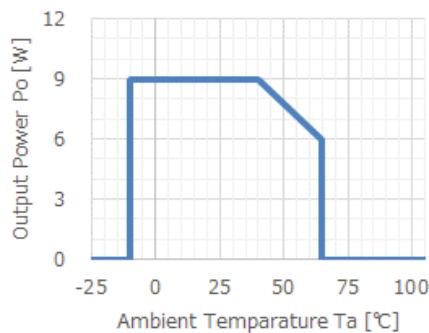

Figure 3. Temperature Derating curve

Application Circuit

$V_{IN} = 90 \sim 264 \text{ Vac}$, $V_{OUT} = 12 \text{ V}$

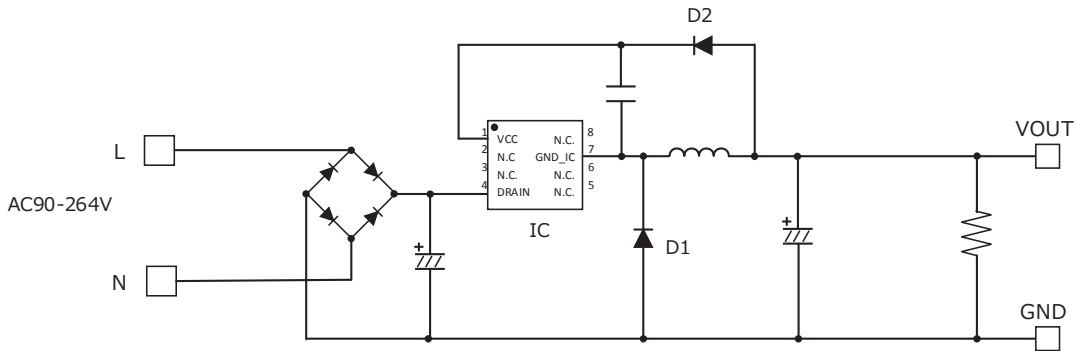

Figure 4. BM2P121X-EVK-001 Application Circuit

The BM2P121X is non-insulation method without opto-coupler and feeds back the VCC voltage to 12.0 V typ. This VCC voltage is the voltage between the VCC pin and the GND_IC pin.

The output voltage VOUT is defined by the following equation.

$$V_{OUT} = V_{CNT} + V_{FD2} - V_{FD1}$$

V_{CNT} : VCC Control Voltage

V_{FD1} : Forward Voltage of diode D1

V_{FD2} : Forward Voltage of diode D2

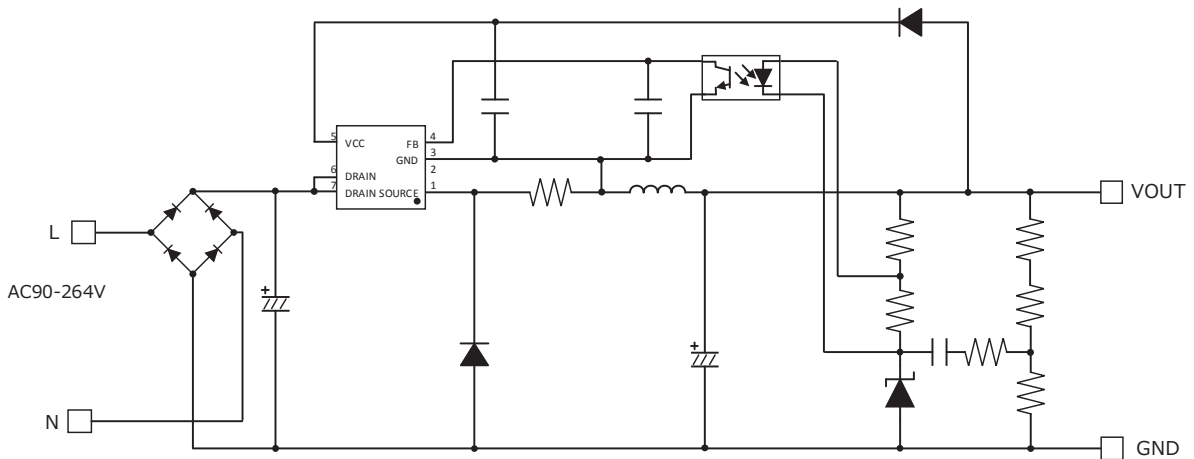

Figure 5. General Buck converter application circuit

Compared to the general Buck converter as shown above, the number of parts is reduced because the feedback circuit is not required. However, the output voltage may rise at light load because the VCC voltage and the output voltage that are fed back are different. In that case, please put a resistance on the output terminal and lower the output voltage.

BM2P121X Overview

Feature

- PWM Frequency=65 kHz
- PWM current mode control
- Switching frequency jitter
- Burst function around light load
- 650 V Starter
- 650 V Super-Junction Power MOSFET
- VCC Under voltage detection
- VCC Over voltage detection
- Cycle by cycle current limiter
- Soft Start function

Key specifications

- Operation Voltage Range: VCC: 9.5 V ~ 12.96 V
DRAIN 650 V(Max)
- Circuit Current(ON): 0.85 mA(Typ)
- Circuit Current (Burst mode): 0.45 mA(Typ)
- Switching Frequency: 65 kHz(Typ)
- Operating Temperature: -40 °C ~ +105 °C
- MOSFET R-ON: 1.5 Ω(Typ)

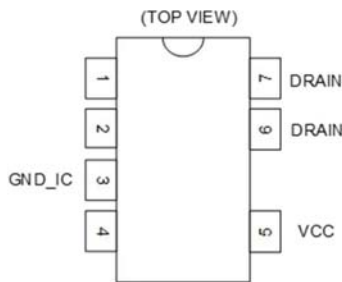

Figure 6. Block Diagram

Dimension

DIP7K

W(Typ) x D(Typ) x H(Max)

9.20 mm x 6.35 mm x 4.30 mm

Pitch 2.54 mm



Figure 7. DIP7K Package

Table 1. BM2P121X PIN description

No.	Name	I/O	Function	ESD Diode	
				VCC	GND
1	-	-	-	-	-
2	-	-	-	-	-
3	GND_IC	I/O	GND	✓	-
4	-	-	-	-	-
5	VCC	I	Vcc	-	✓
6	DRAIN	I/O	MOSEFET DRAIN	-	✓
7	DRAIN	I/O	MOSEFET DRAIN	-	✓

Design Overview

1 Important parameter

- V_{IN} : Input Voltage Range AC 90 V ~ 264 Vac (DC 100 V ~ 380 V)
- V_{OUT} : Output Voltage DC 12 V
- $I_{OUT(Typ)}$: Constant Output Current 0.50 A
- $I_{OUT(Max)}$: Maximum Output Current 0.75 A
- f_{SW} : Switching Frequency Min:60 kHz, Typ:65 kHz, Max:70 kHz
- $I_{peak(Min)}$: Over Current Detection Current Min:1.8 A, Typ:2.0 A, Max:2.2A

2 Coil Selection

2.1 Determining Coil Inductance

The switching operation mode determines the L value so that it becomes as discontinuous mode (DCM) as possible. In the continuous mode (CCM), reverse current in trr of the diode flows, which leads to an increase in power loss of diode. Furthermore, this reverse current becomes the peak current when the MOSFET is ON, and the power loss of the MOSFET also increases. The constant load current $I_{OUT(Typ)}$: 0.5 A, the peak current I_L flowing through the inductor is:

$$I_L = I_{OUT(Typ)} \times 2 = 1.0 \quad [A]$$

It tends to be in continuous mode (CCM) when the input voltage drops.

Calculate with input voltage minimum voltage 100 Vdc with 20% margin and $V_{IN(Min)} = 80$ Vdc.

From the output voltage V_{OUT} : 12 V and the diode V_F : 1 V, Calculate the maximum value of Duty: Duty (Max).

$$Duty(max) = \frac{V_{OUT} + V_F}{V_{IN(Min)}} = 0.163$$

From the minimum switching frequency $f_{SW(Min)} = 60$ kHz, Calculate on time $t_{ON(Max)}$

$$t_{ON(Max)} = \frac{Duty(Max)}{f_{SW(Min)}} = 2.71 \quad [\mu sec]$$

Calculate L value to operate in discontinuous mode.

$$L < t_{ON(Max)} \times \frac{V_{IN(Min)} - V_o}{I_L} = 184.2 \quad [\mu H]$$

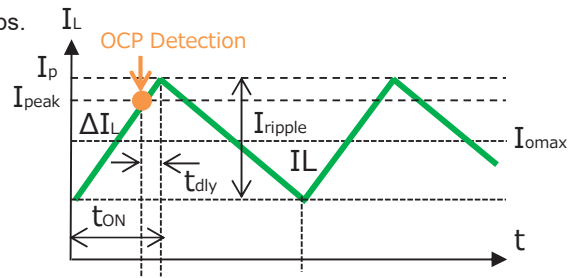

Figure 8. Coil current waveform at OCP detection

2.1 Determining Coil Inductance – Continued

Also, calculate L value so that the overcurrent detection becomes maximum load current I_{OUT} : 750 mA or more. Overcurrent detection is calculated by the current flowing through the MOSFET when operating in continuous mode at the minimum switching frequency f_{SW} (Min) = 60 kHz. When the current flowing through the MOSFET (\neq the coil current at switching ON) exceeds the minimum value I_{peak} (Min): 1.8 A of the overcurrent detection current, the MOSFET is turned OFF. Since a delay of approximately $tdly = 0.1 \mu\text{sec}$ occurs, in reality, the peak current exceeds the I_{peak} value and the peak current becomes I_p . The peak current I_p is obtained by setting the current slope at switching ON to ΔI_L ,

$$I_p = I_{peak} + \Delta I_L \times tdly$$

$$I_p = I_{peak} + \frac{V_{IN} - V_O}{L} \times tdly$$

Calculate the output current I_o (LIM) at overcurrent detection by securing a margin of 10% from the maximum load current of 750 mA, and setting it as 825 mA.

$$I_{OUT}(LIM) = I_p - \frac{I_{ripple}}{2} > I_{OUT}(Max)$$

Calculate the minimum value of the L value of the coil. From the above formula,

$$L > \frac{\{2 \times tdly \times f_{SW}(Min) - (V_{OUT} + V_F)\} \times (V_{IN}(Min) - V_{OUT})}{2 \times f_{SW}(Min) \times (I_{OUT}(Max) - I_{peak}(Min)) \times V_{IN}(Min)} = 100.5 \quad [\mu\text{H}]$$

Therefore, the inductance value of the coil is discontinuous mode when the rated current I_o (Typ) is 0.5 A, and in order to detect the overcurrent of the maximum load current I_o (Max): 0.75 A or more, the condition of 100.5 μH to 184.2 μH , A coil of 150 μH is selected.

2.2 Inductor Current Calculation

Calculate the maximum peak current of the inductor. The condition where the peak current is maximized is when the input voltage is the maximum voltage V_{IN} (Max): 380 V, the maximum load current I_o (Max): 0.75 A, and the switching frequency is 60 kHz at the minimum. The ripple current I_{ripple} of the coil is given by the following formula.

$$I_{ripple} = \frac{di}{dt} \times t_{ON} = \frac{\{V_{IN}(Max) - (V_{OUT} + V_F)\}}{L} \times \frac{(V_{OUT} + V_F)}{V_{IN}(Max) \times f_{SW}(Min)}$$

2.2 Inductor Current Calculation -Continued

When it is applied to the formula of the peak current,

$$I_p = I_{OUT}(Max) + \frac{I_{ripple}}{2} = I_O + \frac{\{V_{IN}(Max) - (V_{OUT} + V_F)\}(V_{OUT} + V_F)}{2 \times L \times V_{IN}(Max) \times f_{SW}(Min)} = 1.58 \quad [A]$$

Select a coil with an allowable current of 1.58 A or more.

In this EVK, we use inductance value: 150 μ H, rated: 1.9 A product.

Radial inductor (closed magnetic circuit type) Core size DR09 x 11 series

Product: XF1501Y-151

Manufacturer: ALPHA TRANS CO., LTD

〒541-0059 Senbanishi KID Bldg 7F, 4-4-11, Bakurou-machi, Chuo-ku, Osaka

<http://www.alphatrans.jp/>

3 Diode Selection

3.1 Flywheel Diode : D1

Flywheel diode uses fast diode (fast recovery diode). The reverse voltage of the diode is V_{IN} (Max): 380 V when the output voltage at startup is 0 V. Consider the derating and select 600 V diode. The condition where the effective current of the diode is maximized is when the input voltage is the maximum voltage V_{IN} (Max): 380 V, the maximum load current I_O (Max): 0.75 A, and the switching frequency is 60 kHz at the minimum.

$$Duty = \frac{V_{OUT} + V_F}{V_{IN}(Max)} = 2.9 \quad [\%]$$

The average current I_D of the diode is calculated from the peak current I_p : 1.35 A by the following formula

$$I_D(rms) = I_p \times \sqrt{\frac{1 - Duty}{3}} = 0.765 \quad [A]$$

Select the rated current of 0.765 A or more.

In fact, we used RFN5BM6S of 5 A / 600 V product as a result of mounting the board and considering the parts temperature.

3.2 VCC Rectifier Diode : D1

Rectifier diodes are used for diodes to supply VCC. The reverse voltage applied to the diode is V_{IN} (Max): 380 V. Consider the derating and select 600 V diode. Because the current flowing to the IC is small enough, we use the 0.2 A / 600 V RRE02VSM6S.

Design Overview – Continued

4 Capacitor Selection

4.1 Input Capacitor : C4

The input capacitor is determined by input voltage V_I and output power P_{OUT} . As a guide, for an input voltage of 90 to 264 Vac, $2 \times P_{OUT}$ [W] μ F. For 176 to 264 Vac, set $1 \times P_{OUT}$ [W] μ F. Since the output power $P_{OUT} = 9$ W, 22μ F / 450 V is selected at 18μ F or more.

4.2 VCC Capacitor : C6

The VCC capacitor C_{VCC} is required for stable operation of the device and stable feedback of the output voltage. A withstand voltage of 25 V or more is required, and 1.0μ F to 4.7μ F is recommended. 2.2μ F / 50 V is selected.

4.3 Output Capacitor : C7, C8

For the output capacitor, select output voltage V_O of 25 V or more in consideration of derating. For C7 electrolytic capacitors, capacitance, impedance and rated ripple current must be taken into consideration.

The output ripple voltage is a composite waveform generated by electrostatic capacity: C_{out} , impedance: ESR when the ripple component of inductor current: ΔI_L flows into the output capacitor and is expressed by the following formula.

$$\Delta V_{ripple} = \Delta I_L \times \left(\frac{1}{8 \times C_{out} \times f_{sw}} \right) + ESR$$

The inductor ripple current,

$$\Delta I_L = 2 \times \{I_p - I_{OUT(max)}\} = 2 \times (1.58 - 0.75) = 1.66 \quad [A]$$

For this EVK, we use electrostatic capacity: 680μ F, ESR: 0.049Ω , and the design value of output ripple voltage is less than 100 mV.

$$\Delta V_{ripple} = \Delta I_L \times \left\{ \left(\frac{1}{8 \times C_{out} \times f_{sw}} \right) + ESR \right\} = 1.66 \times \left\{ \left(\frac{1}{8 \times 680 \mu \times 65k} \right) + 0.049 \right\} = 81.3 \quad [mV]$$

Next, check whether the ripple current of the capacitor satisfies the rated ripple current.

Inductor ripple current RMS conversion,

$$I_L[rms] = \Delta I_L \times \sqrt{\frac{1}{3}} = 0.96 \quad [A]$$

The ripple current of the capacitor,

$$I_C[rms] = \sqrt{I_L^2 - I_{OUT}^2} = \sqrt{0.96^2 - 0.75^2} = 0.60 \quad [A]$$

4.3 Output Capacitor C7, C8 – Continued

Select a rated current of 0.60 A or more.

The output capacitor C7 used a rated ripple current of 1.24 A at 680 μF / 25 V.

C8 has added a 0.1 μF ceramic capacitor to reduce switching noise.

5 Resistor Selection

5.1 Discharge Resistor : R1,R2,R3

The resistor is for discharging X - Capacitor (C1). Considering withstand voltage, 3 pcs of chip resistance of ROHM product MCR18 (200 V withstand voltage) are connected in series. 220 k Ω is used in 3 pcs in series so that it becomes 45 V or less after 1 second after turning off the power supply.

5.2 Bleeder Resistor : R4

Because it is indirectly fed back to the output voltage, the output voltage increases at light load. This board uses bleeder resistance for its improvement. Reducing the resistance value improves the rise in the output voltage of the light load, but increases the power loss. 10 k Ω / 0.25 W is used.

6 EMI Filter Selection

As a measure against "Conducted Emission", Input filter is composed of X-Capacitor: C1 and common mode filter LF1.

X-Capacitor uses 0.22 μF / X 2. The common mode filter uses 13 mH (Min) / 1 A.

As a measure against "Radiated Emission", Input filter is composed of Y-Capacitor: C2, C3 and a common mode filter LF2.

Y - Capacitor uses 2200 pF / Y1 and connects the midpoint to the output capacitor so that high frequency noise is not propagated from the input. Moreover, the common mode filter uses 60 μH (Min) / 1 A with good characteristics of the 100 MHz band. If "Radiated Emission" does not have a problem in the state that it is loaded in the set, C2, C3, LF2 are unnecessary.

Performance Data

Constant Load Regulation

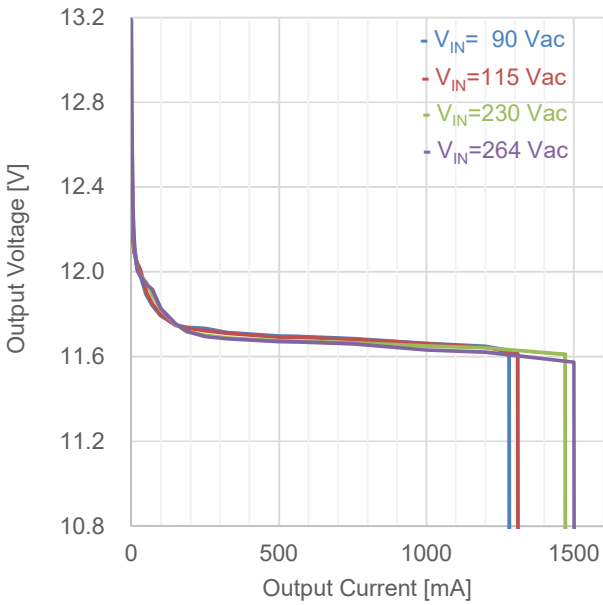

Figure 8. Load Regulation (I_{OUT} vs. V_{OUT})

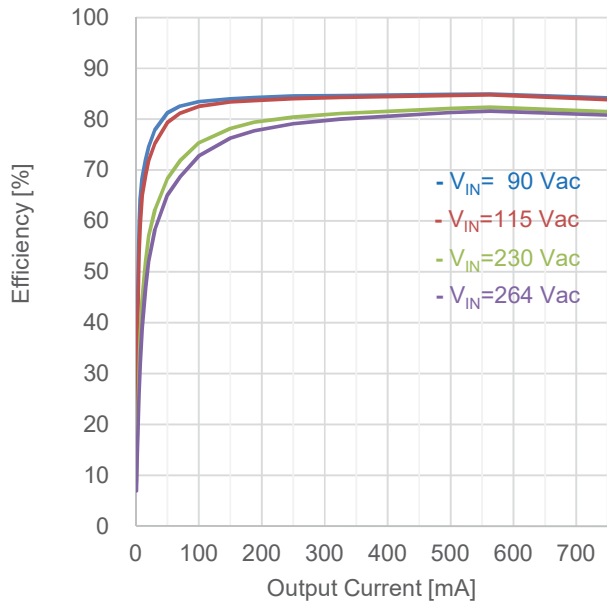

Figure 9. Load Regulation (I_{OUT} vs. Efficiency)

Table 2. Load Regulation ($V_{IN}=115$ Vac)

I_{OUT}	V_{OUT}	Efficiency
188 mA	11.735 V	83.69 %
375 mA	11.703 V	84.45 %
563 mA	11.691 V	84.77 %
750 mA	11.681 V	83.84 %

Table 3. Load Regulation ($V_{IN}=230$ Vac)

I_{OUT}	V_{OUT}	Efficiency
188 mA	11.718 V	79.39 %
375 mA	11.681 V	81.51 %
563 mA	11.673 V	82.35 %
750 mA	11.665 V	81.46 %

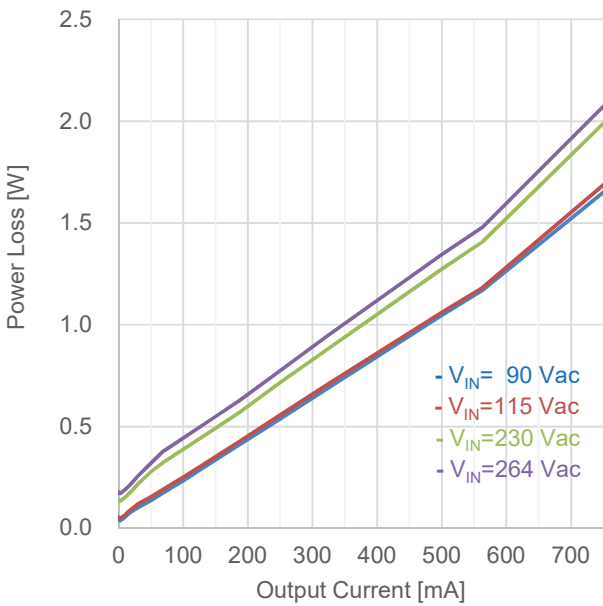

Figure 10. Load Regulation (I_{OUT} vs. P_{LOSS})

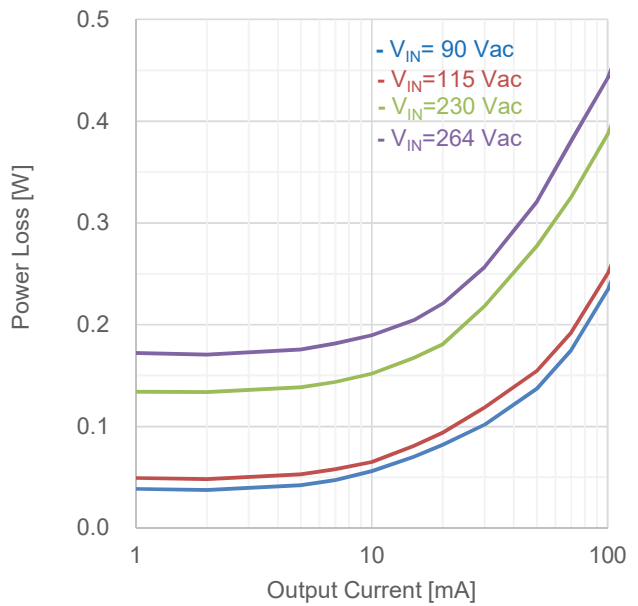

Figure 11. Load Regulation (I_{OUT} vs. P_{LOSS})

Performance Data -Continued

Table 4. Load Regulation : V_{IN}=90 Vac

V _{IN} [Vac]	P _{IN} [W]	V _{OUT} [V]	I _{OUT} [mA]	P _{OUT} [W]	P _{LOSS} [W]	Efficiency [%]
90	0.04	12.506	0	0.000	0.042	0.00
90	0.05	12.391	1	0.012	0.039	24.30
90	0.06	12.298	2	0.025	0.037	39.67
90	0.10	12.158	5	0.061	0.042	59.02
90	0.13	12.115	7	0.085	0.047	64.25
90	0.18	12.088	10	0.121	0.056	68.29
90	0.25	12.060	15	0.181	0.070	72.07
90	0.32	12.040	20	0.241	0.082	74.55
90	0.46	11.979	30	0.359	0.102	77.95
90	0.73	11.892	50	0.595	0.137	81.23
90	1.00	11.842	70	0.829	0.175	82.56
90	1.41	11.791	100	1.179	0.234	83.45
90	2.10	11.749	150	1.762	0.336	84.00
90	2.62	11.738	188	2.207	0.412	84.26
90	3.47	11.732	250	2.933	0.537	84.52
90	4.50	11.713	325	3.807	0.691	84.63
90	6.90	11.697	500	5.849	1.047	84.82
90	7.75	11.696	563	6.585	1.168	84.93
90	10.42	11.685	750	8.764	1.651	84.15
90	14.01	11.662	1000	11.662	2.346	83.25
90	16.97	11.649	1200	13.979	2.988	82.39
90	18.15	11.630	1280	14.886	3.267	82.01
90	0.07	0.000	1290	0.000	0.066	0.00

Table 5. Load Regulation: V_{IN}=100 Vac

V _{IN} [Vac]	P _{IN} [W]	V _{OUT} [V]	I _{OUT} [mA]	P _{OUT} [W]	P _{LOSS} [W]	Efficiency [%]
100	0.05	12.598	0	0.000	0.047	0.00
100	0.06	12.451	1	0.012	0.043	22.64
100	0.07	12.343	2	0.025	0.041	37.40
100	0.11	12.182	5	0.061	0.046	56.93
100	0.14	12.134	7	0.085	0.051	62.45
100	0.18	12.100	10	0.121	0.059	67.22
100	0.26	12.072	15	0.181	0.074	71.01
100	0.33	12.050	20	0.241	0.086	73.70
100	0.47	11.999	30	0.360	0.107	77.08
100	0.74	11.902	50	0.595	0.143	80.64
100	1.01	11.850	70	0.830	0.181	82.13
100	1.42	11.798	100	1.180	0.238	83.20
100	2.10	11.752	150	1.763	0.339	83.86
100	2.62	11.740	188	2.207	0.416	84.14
100	3.47	11.727	250	2.932	0.542	84.41
100	4.50	11.715	325	3.807	0.693	84.61
100	6.89	11.696	500	5.848	1.044	84.85
100	7.75	11.695	563	6.584	1.168	84.94
100	10.42	11.684	750	8.763	1.661	84.07
100	14.03	11.663	1000	11.663	2.364	83.15
100	16.95	11.645	1200	13.974	2.980	82.42
100	18.31	11.631	1290	15.004	3.308	81.94
100	0.07	0.000	1300	0.000	0.070	0.00

Table 6. Load Regulation: V_{IN}=115 Vac

V _{IN} [Vac]	P _{IN} [W]	V _{OUT} [V]	I _{OUT} [mA]	P _{OUT} [W]	P _{LOSS} [W]	Efficiency [%]
115	0.05	12.638	0	0.000	0.054	0.00
115	0.06	12.480	1	0.012	0.050	20.13
115	0.07	12.361	2	0.025	0.048	33.87
115	0.11	12.185	5	0.061	0.053	53.44
115	0.14	12.132	7	0.085	0.058	59.39
115	0.19	12.088	10	0.121	0.065	64.99
115	0.26	12.061	15	0.181	0.081	69.05
115	0.34	12.040	20	0.241	0.094	71.88
115	0.48	12.011	30	0.360	0.119	75.23
115	0.75	11.904	50	0.595	0.155	79.36
115	1.02	11.850	70	0.830	0.193	81.16
115	1.43	11.797	100	1.180	0.250	82.50
115	2.11	11.747	150	1.762	0.351	83.39
115	2.64	11.735	188	2.206	0.430	83.69
115	3.49	11.723	250	2.931	0.556	84.05
115	4.52	11.711	325	3.806	0.709	84.30
115	6.91	11.692	500	5.846	1.061	84.64
115	7.77	11.691	563	6.582	1.183	84.77
115	10.45	11.681	750	8.761	1.688	83.84
115	14.07	11.661	1000	11.661	2.404	82.91
115	17.00	11.644	1200	13.973	3.026	82.20
115	18.68	11.613	1310	15.213	3.463	81.46
115	0.09	0.000	1320	0.000	0.090	0.00

Table 7. Load Regulation: V_{IN}=176 Vac

V _{IN} [Vac]	P _{IN} [W]	V _{OUT} [V]	I _{OUT} [mA]	P _{OUT} [W]	P _{LOSS} [W]	Efficiency [%]
176	0.09	12.839	0	0.000	0.092	0.00
176	0.10	12.624	1	0.013	0.087	12.62
176	0.11	12.463	2	0.025	0.087	22.26
176	0.15	12.223	5	0.061	0.091	40.21
176	0.18	12.151	7	0.085	0.096	46.99
176	0.23	12.092	10	0.121	0.104	53.74
176	0.30	12.041	15	0.181	0.118	60.41
176	0.38	12.023	20	0.240	0.138	63.61
176	0.53	11.991	30	0.360	0.165	68.52
176	0.81	11.938	50	0.597	0.215	73.51
176	1.08	11.864	70	0.830	0.254	76.61
176	1.49	11.804	100	1.180	0.314	79.01
176	2.18	11.742	150	1.761	0.416	80.90
176	2.70	11.732	188	2.206	0.496	81.63
176	3.56	11.714	250	2.929	0.632	82.26
176	4.60	11.701	325	3.803	0.792	82.76
176	7.00	11.683	500	5.842	1.159	83.45
176	7.86	11.682	563	6.577	1.283	83.68
176	10.61	11.674	750	8.756	1.850	82.56
176	14.42	11.659	1000	11.659	2.757	80.88
176	17.45	11.647	1200	13.976	3.470	80.11
176	20.43	11.593	1390	16.114	4.314	78.88
176	0.16	0.000	1400	0.000	0.161	0.00

Performance Data -Continued

Table 8. Load Regulation : $V_{IN}=230$ Vac

V_{IN} [Vac]	P_{IN} [W]	V_{OUT} [V]	I_{OUT} [mA]	P_{OUT} [W]	P_{LOSS} [W]	Efficiency [%]
230	0.14	13.056	0	0.000	0.139	0.00
230	0.15	12.785	1	0.013	0.134	8.70
230	0.16	12.580	2	0.025	0.134	15.82
230	0.20	12.277	5	0.061	0.139	30.69
230	0.23	12.185	7	0.085	0.144	37.25
230	0.27	12.110	10	0.121	0.152	44.36
230	0.35	12.045	15	0.181	0.167	51.92
230	0.42	12.011	20	0.240	0.181	57.06
230	0.58	11.982	30	0.359	0.219	62.19
230	0.88	11.950	50	0.598	0.278	68.29
230	1.16	11.893	70	0.833	0.325	71.89
230	1.57	11.819	100	1.182	0.387	75.33
230	2.25	11.751	150	1.763	0.491	78.20
230	2.78	11.718	188	2.203	0.572	79.39
230	3.64	11.700	250	2.925	0.715	80.36
230	4.68	11.689	325	3.799	0.884	81.12
230	7.11	11.674	500	5.837	1.273	82.10
230	7.98	11.673	563	6.572	1.408	82.35
230	10.74	11.665	750	8.749	1.991	81.46
230	14.67	11.650	1000	11.650	3.020	79.41
230	17.83	11.641	1200	13.969	3.861	78.35
230	22.48	11.611	1470	17.068	5.412	75.93
230	0.23	0.000	1480	0.000	0.230	0.00

Table 9. Load Regulation: $V_{IN}=264$ Vac

V_{IN} [Vac]	P_{IN} [W]	V_{OUT} [V]	I_{OUT} [mA]	P_{OUT} [W]	P_{LOSS} [W]	Efficiency [%]
264	0.18	13.189	0	0.000	0.178	0.00
264	0.19	12.885	1	0.013	0.172	6.96
264	0.20	12.655	2	0.025	0.171	12.91
264	0.24	12.310	5	0.062	0.175	25.97
264	0.27	12.208	7	0.085	0.182	32.01
264	0.31	12.122	10	0.121	0.190	38.98
264	0.39	12.047	15	0.181	0.204	46.94
264	0.46	12.008	20	0.240	0.221	52.10
264	0.62	11.978	30	0.359	0.257	58.33
264	0.92	11.942	50	0.597	0.321	65.04
264	1.22	11.918	70	0.834	0.381	68.66
264	1.63	11.827	100	1.183	0.442	72.78
264	2.31	11.755	150	1.763	0.549	76.27
264	2.83	11.720	188	2.203	0.630	77.77
264	3.70	11.695	250	2.924	0.773	79.08
264	4.75	11.684	325	3.797	0.950	79.99
264	7.18	11.671	500	5.836	1.345	81.27
264	8.05	11.670	563	6.570	1.480	81.62
264	10.82	11.661	750	8.746	2.074	80.83
264	14.77	11.631	1000	11.631	3.139	78.75
264	18.00	11.621	1200	13.945	4.055	77.47
264	23.33	11.574	1500	17.361	5.969	74.41
264	0.29	0.000	1510	0.000	0.294	0.00

Performance Data -Continued

Line Regulation

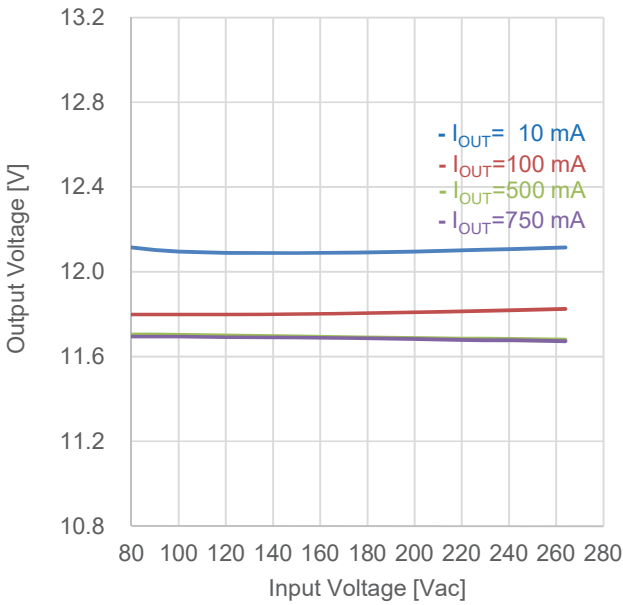

Figure 12. Line Regulation (I_{IN} vs. V_{OUT})

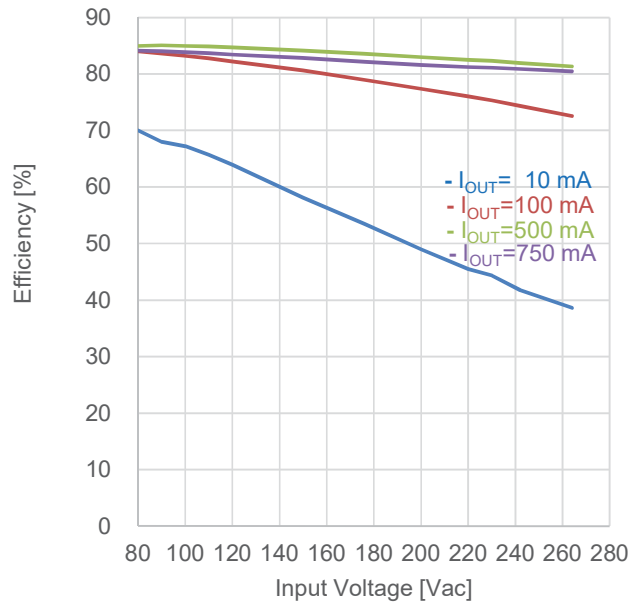

Figure 13. Line Regulation (I_{IN} vs. Efficiency)

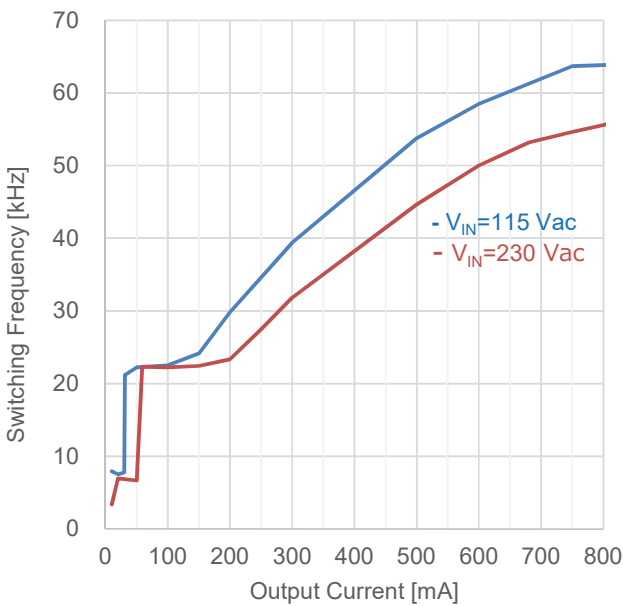

Figure 14. Switching Frequency (I_{OUT} vs. F_{SW})

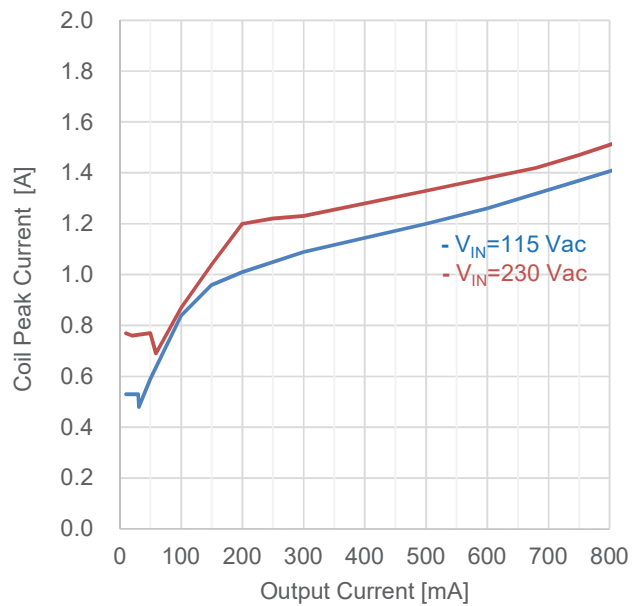

Figure 15. Coil Peak Current (I_{OUT} vs. I_{peak})

Performance Data -Continued

Operation Waveform

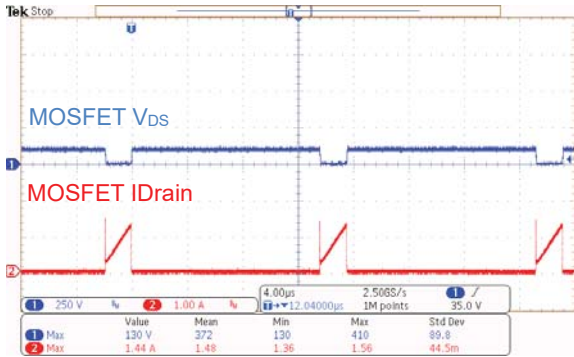

Figure 16. MOSFET $V_{IN} = 90 \text{ Vac}$, $I_{OUT} = 0.75 \text{ A}$

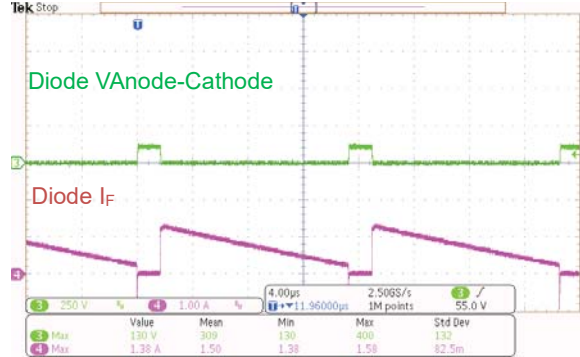

Figure 17. Diode $V_{IN} = 90 \text{ Vac}$, $I_{OUT} = 0.75 \text{ A}$

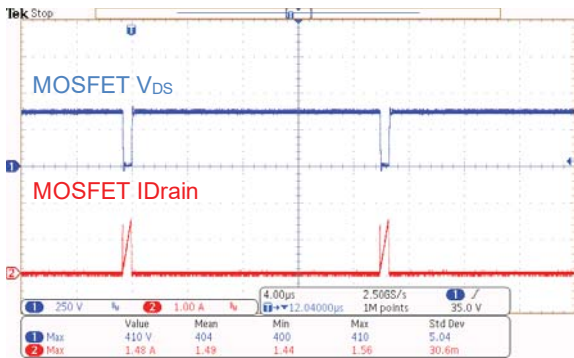

Figure 18. MOSFET $V_{IN} = 264 \text{ Vac}$, $I_{OUT} = 0.75 \text{ A}$

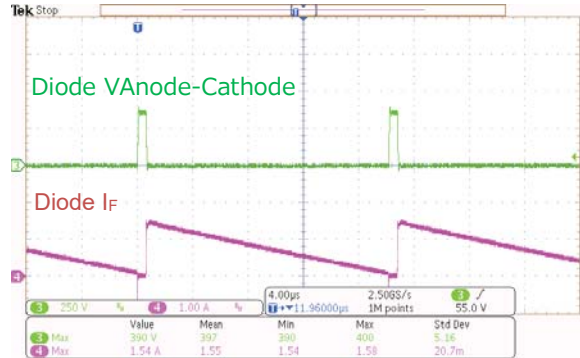

Figure 19. Diode $V_{IN} = 264 \text{ Vac}$, $I_{OUT} = 0.75 \text{ A}$

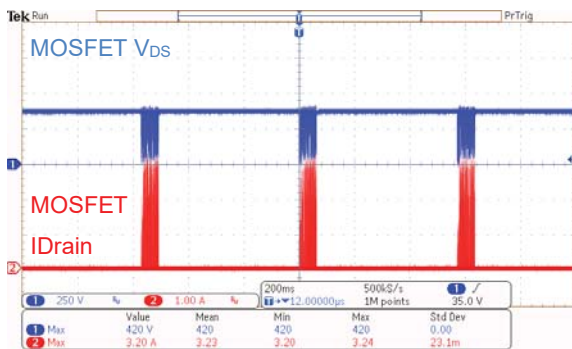

Figure 20. MOSFET $V_{IN} = 264 \text{ Vac}$, Output Short

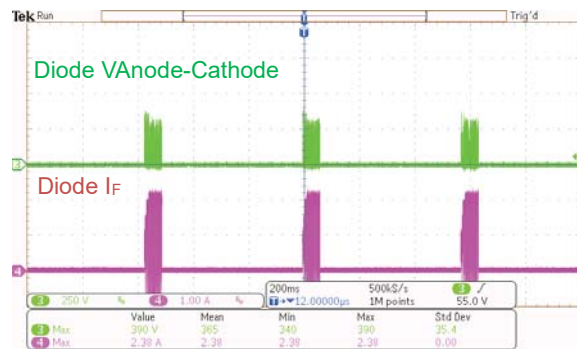

Figure 21. Diode $V_{IN} = 264 \text{ Vac}$, Output Short

Performance Data -Continued

Power ON

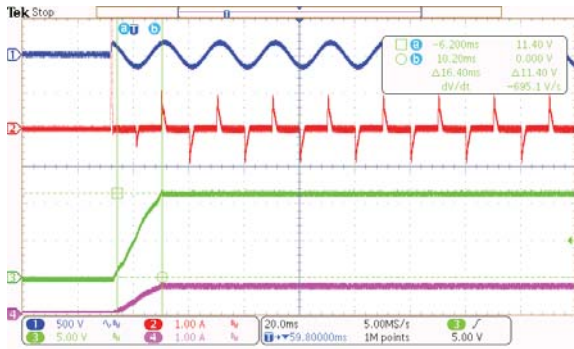

Figure 22. $V_{IN} = 115 \text{ Vac}$, $I_{OUT} = 0.75 \text{ A}$

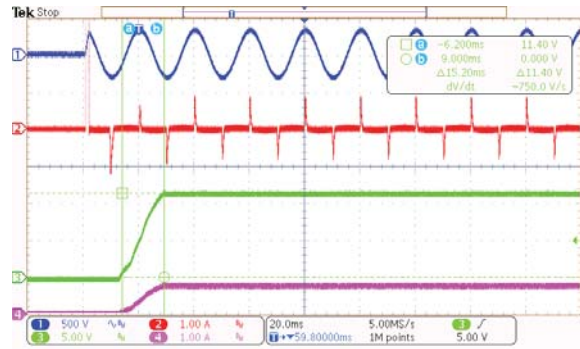

Figure 23. $V_{IN} = 230 \text{ Vac}$, $I_{OUT} = 0.75 \text{ A}$

Dynamic Response

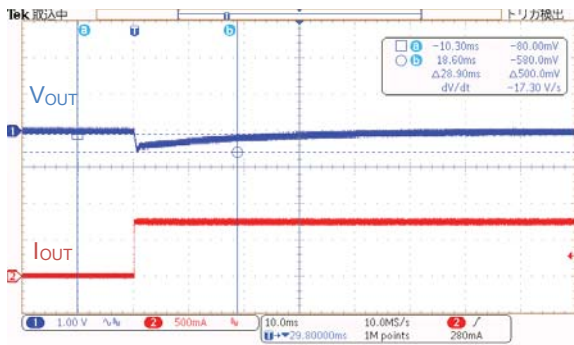

Figure 24. $V_{IN} = 115 \text{ Vac}$, $I_{OUT} = 10 \text{ mA} \rightarrow 0.75 \text{ A}$

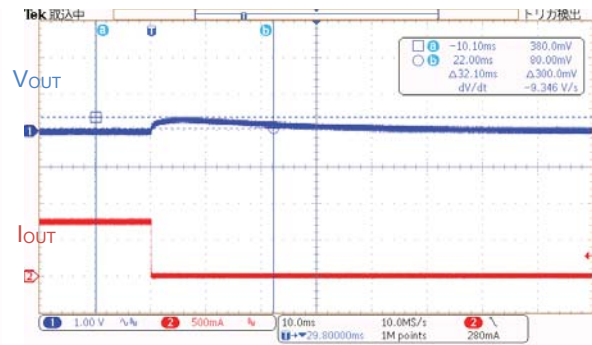

Figure 25. $V_{IN} = 115 \text{ Vac}$, $I_{OUT} = 0.75 \text{ A} \rightarrow 10 \text{ mA}$

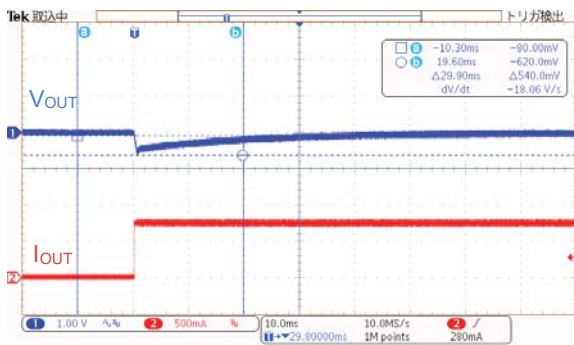

Figure 26. $V_{IN} = 230 \text{ Vac}$, $I_{OUT} = 10 \text{ mA} \rightarrow 0.75 \text{ A}$

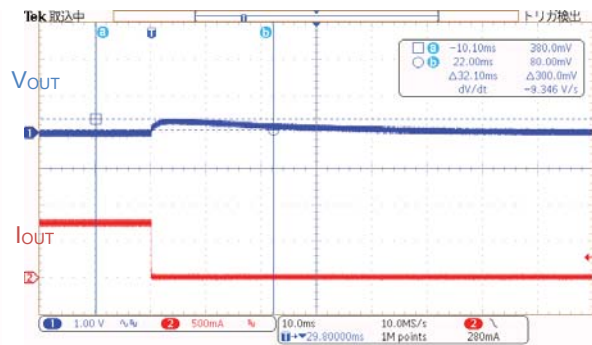

Figure 27. $V_{IN} = 230 \text{ Vac}$, $I_{OUT} = 0.75 \text{ A} \rightarrow 10 \text{ mA}$

Performance Data -Continued

Output Ripple Voltage

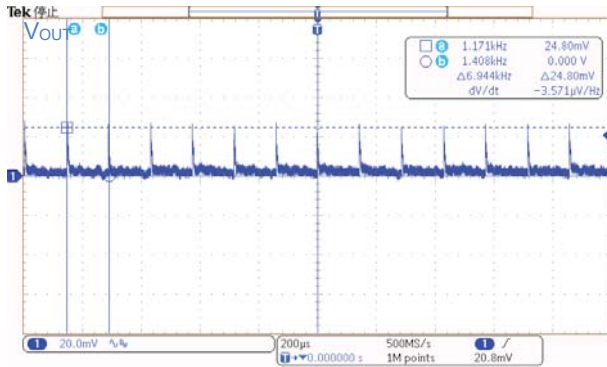

Figure 28. $V_{IN} = 115 \text{ Vac}$, $I_{OUT} = 10 \text{ mA}$

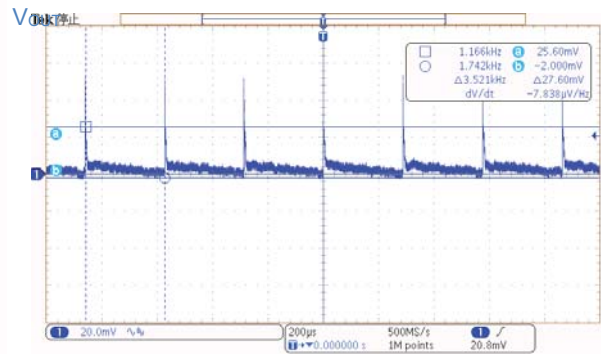

Figure 29. $V_{IN} = 230 \text{ Vac}$, $I_{OUT} = 10 \text{ mA}$

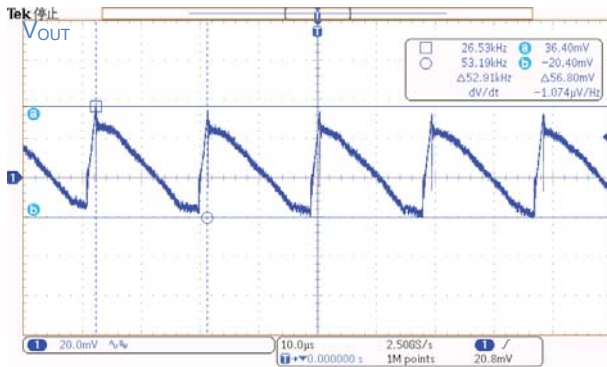

Figure 30. $V_{IN} = 115 \text{ Vac}$, $I_{OUT} = 0.5 \text{ A}$

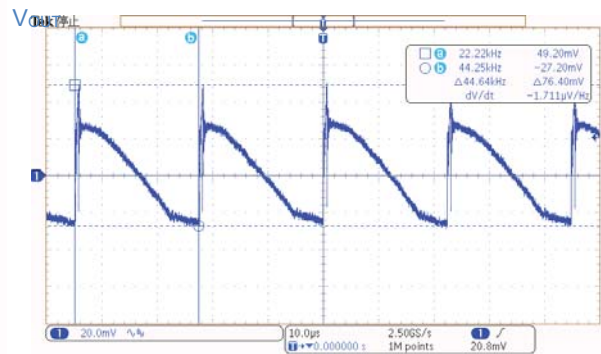

Figure 31. $V_{IN} = 230 \text{ Vac}$, $I_{OUT} = 0.5 \text{ A}$

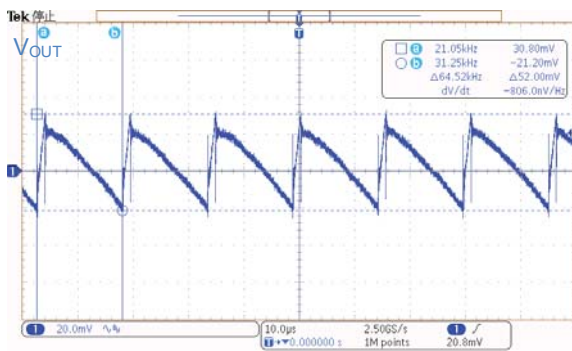

Figure 32. $V_{IN} = 115 \text{ Vac}$, $I_{OUT} = 0.75 \text{ A}$

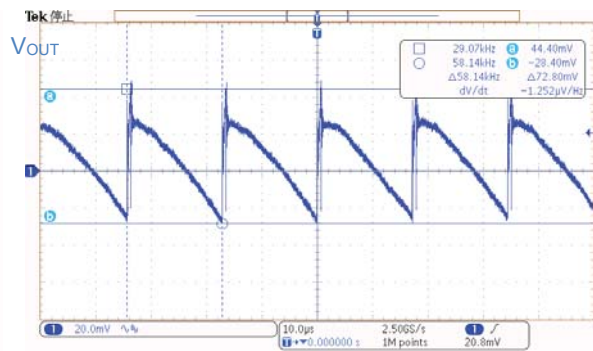

Figure 33. $V_{IN} = 230 \text{ Vac}$, $I_{OUT} = 0.75 \text{ A}$

Performance Data -Continued

Parts surface temperature

Table 10. Parts surface temperature

Ta = 25 °C, measured 30 minutes after startup

Part	Condition			
	V _{IN} = 90 Vac, I _{OUT} = 0.50 A	V _{IN} = 90 Vac, I _{OUT} = 0.75 A	V _{IN} = 264 Vac, I _{OUT} = 0.50 A	V _{IN} = 264 Vac, I _{OUT} = 0.75 A
IC1	45.9 °C	71.9 °C	52.4 °C	83.4 °C
D1	59.6 °C	76.2 °C	61.5 °C	83.0 °C
DB1	45.3 °C	53.5 °C	39.7 °C	48.2 °C
L1	40.6 °C	60.8 °C	47.9 °C	66.7 °C

EMI

•Conducted Emission: CISPR22 Pub 22 Class B

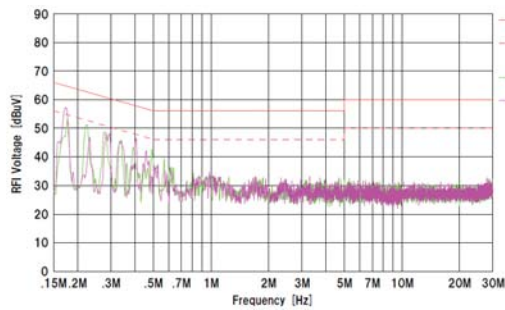

Figure 34. V_{IN} = 110 Vac / 60 Hz, I_{OUT} = 0.75 A
QP margin = 17.5 dB, AV margin = 20.8 dB

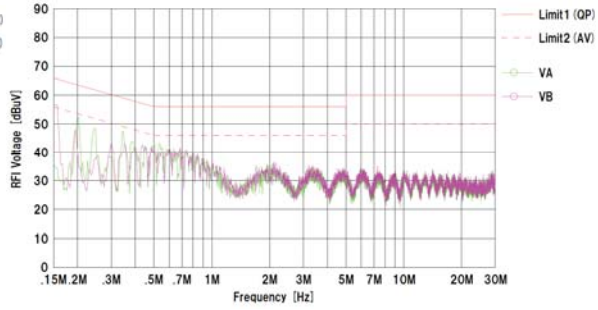

Figure 35. V_{IN} = 230 Vac / 50 Hz, I_{OUT} = 0.75 A
QP margin = 23.5 dB, AV margin = 26.5 dB

•Radiated Emission: CISPR22 Pub 22 Class B

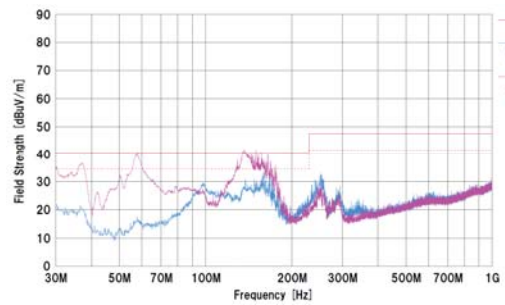

Figure 36. V_{IN} = 110 Vac / 60 Hz, I_{OUT} = 0.75 A
QP margin = 7.3 dB

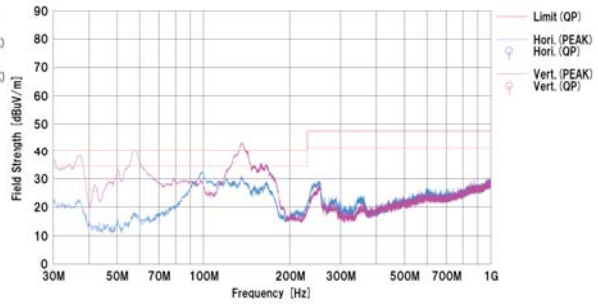

Figure 37. V_{IN} = 230 Vac / 50 Hz, I_{OUT} = 0.75 A
QP margin = 6.2 dB

Schematics

$V_{IN} = 90 \sim 264 \text{ Vac}$, $V_{OUT} = 12 \text{ V}$

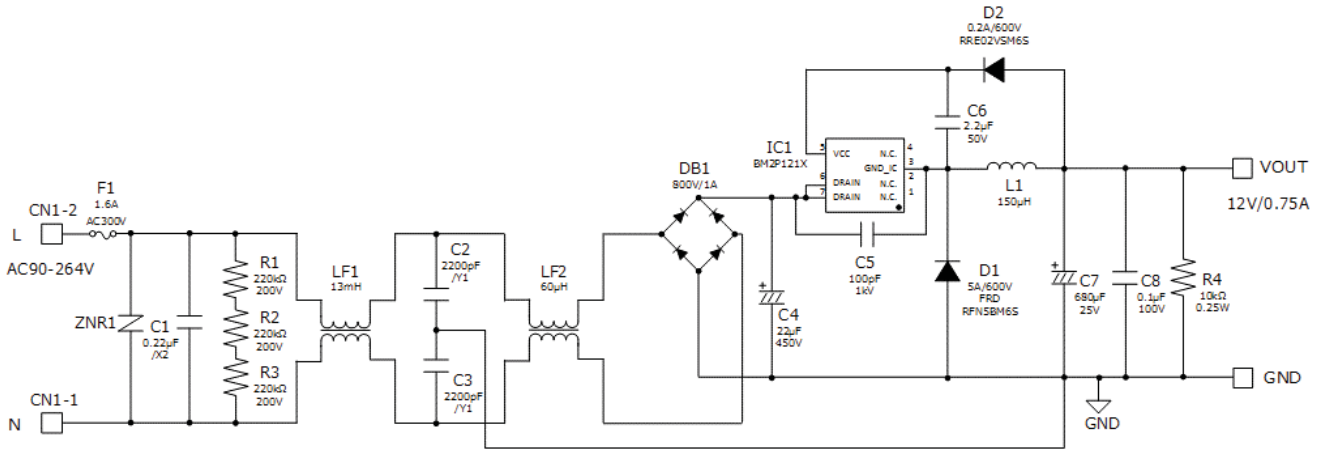

Figure 38. BM2P121X-EVK-001 Schematics

Bill of Materials

Table 11. BoM of BM2P121X-EVK-001

Part Reference	Qty.	Type	Value	Description	Part Number	Manufacture	Configuration mm (inch)
C1	1	X2 Capacitor	0.22µF	275Vac, ±20%	890324023028CS	Würth	-
C2,C3	2	Y1 Capacitor	2200pF	Y1 capacitor	DE1E3KX222MB4BP01F	Murata	-
C4	1	Electrolytic	22µF	450V, ±20%	450BXW22MEFR12.5X20	Rubycon	12.5mmΦX20mm
C5	1	Ceramic	100pF	1kV, C0G, ±10%	GRM31A5C3A101J	Murata	3216 (1206)
C6	1	Ceramic	2.2µF	50V, X7R, ±10%	UMK316B7225KL-T	Taiyo Yuden	3216 (1206)
C7	1	Electrolytic	680µF	25V, ±20%	UPA1E681MPD	Nichicon	10mmΦX16mm
C8	1	Ceramic	0.1µF	100V, X7R, ±10%	HMK107B7104MA-T	Taiyo Yuden	1608 (0603)
CN1	1	Connector	2pin	5mm pitch	B2P-NV	JST	-
D1	1	FRD	5A	600V	RFN5BM6S	ROHM	TO-252
D2	1	REC Di	0.2A	600V	RRE02VSM6S	ROHM	TUMD2SM
DB1	1	Bridge	1A	800V	D1UBA80	Shindengen	SOP-4
F1	1	Fuse	1.6A	1.6A 300V	36911600000	Littelfuse	-
IC1	1	AC/DC Converter	-	650V	BM2P121X-Z	ROHM	DIP7
JP1	1	Jumper	-	Jumper Wire	-	-	Φ0.5mm
L1	1	Coil	150µH	1.9A	XF1501Y-151	Alpha Trans	-
LF1	1	Line Filter	13mH	1A	XF1482Y	Alpha Trans	-
LF2	1	Line Filter	60µH	1A	LF1246Y	Alpha Trans	-
PCB	1	FR4	-	-	-	-	-
R1,R2,R3	3	Resistor	220kΩ	0.25W, ±5%	MCR18EZPJ224	ROHM	3216 (1206)
R4	1	Resistor	10kΩ	0.25W, ±5%	MCR18EZPJ103	ROHM	3216 (1206)
ZNR1	1	Varistor	-	300Vac, 423Vmin, 400A	V470ZA05P	Littelfuse	5mmΦ Disc

PCB

Size : 91 mm x 30 mm

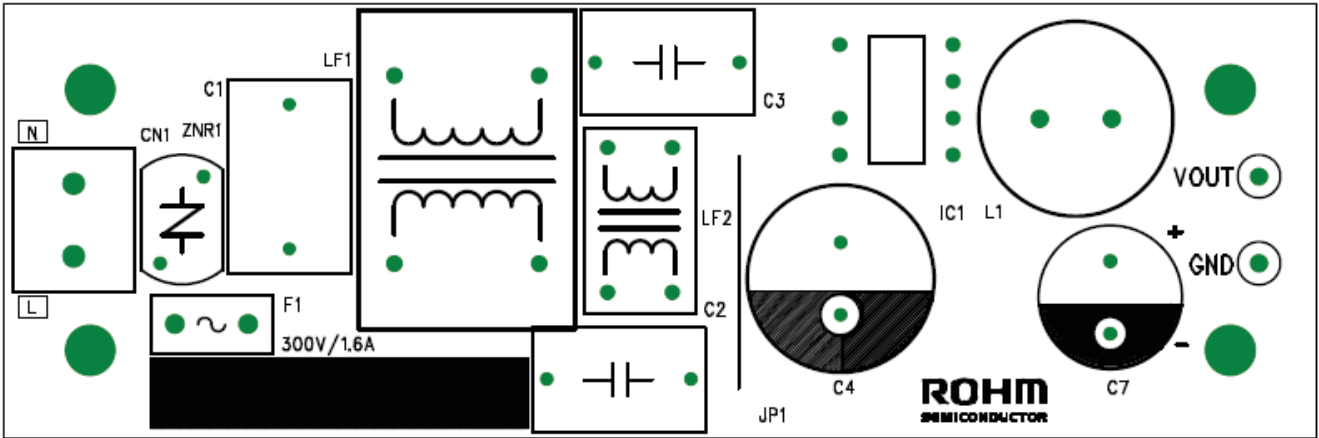

Figure 39. Top Silkscreen (Top view)

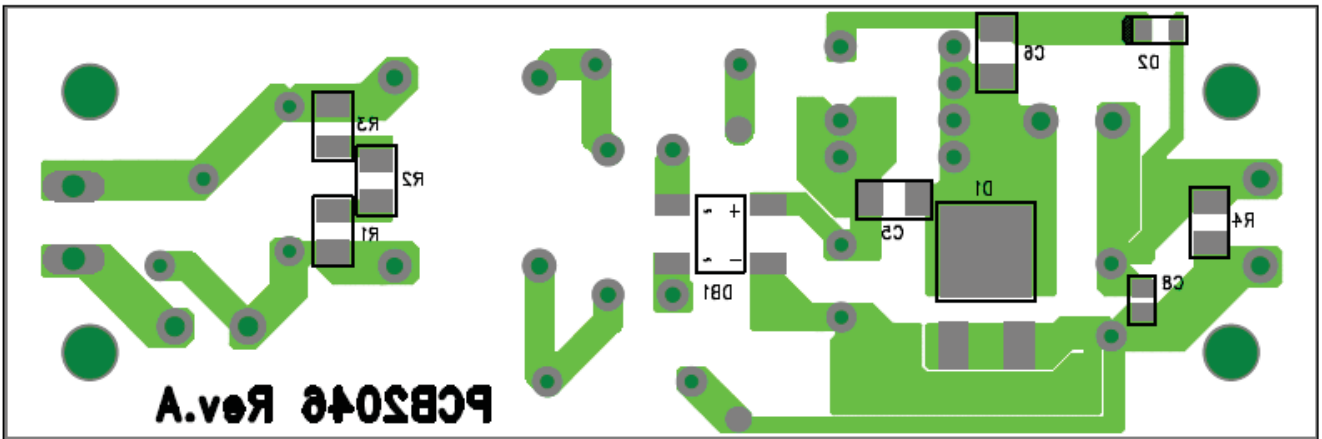

Figure 40. Bottom Layout (Top view)

Notes

- 1) The information contained herein is subject to change without notice.
- 2) Before you use our Products, please contact our sales representative and verify the latest specifications :
- 3) Although ROHM is continuously working to improve product reliability and quality, semiconductors can break down and malfunction due to various factors.
Therefore, in order to prevent personal injury or fire arising from failure, please take safety measures such as complying with the derating characteristics, implementing redundant and fire prevention designs, and utilizing backups and fail-safe procedures. ROHM shall have no responsibility for any damages arising out of the use of our Products beyond the rating specified by ROHM.
- 4) Examples of application circuits, circuit constants and any other information contained herein are provided only to illustrate the standard usage and operations of the Products. The peripheral conditions must be taken into account when designing circuits for mass production.
- 5) The technical information specified herein is intended only to show the typical functions of and examples of application circuits for the Products. ROHM does not grant you, explicitly or implicitly, any license to use or exercise intellectual property or other rights held by ROHM or any other parties. ROHM shall have no responsibility whatsoever for any dispute arising out of the use of such technical information.
- 6) The Products specified in this document are not designed to be radiation tolerant.
- 7) For use of our Products in applications requiring a high degree of reliability (as exemplified below), please contact and consult with a ROHM representative : transportation equipment (i.e. cars, ships, trains), primary communication equipment, traffic lights, fire/crime prevention, safety equipment, medical systems, servers, solar cells, and power transmission systems.
- 8) Do not use our Products in applications requiring extremely high reliability, such as aerospace equipment, nuclear power control systems, and submarine repeaters.
- 9) ROHM shall have no responsibility for any damages or injury arising from non-compliance with the recommended usage conditions and specifications contained herein.
- 10) ROHM has used reasonable care to ensure the accuracy of the information contained in this document. However, ROHM does not warrants that such information is error-free, and ROHM shall have no responsibility for any damages arising from any inaccuracy or misprint of such information.
- 11) Please use the Products in accordance with any applicable environmental laws and regulations, such as the RoHS Directive. For more details, including RoHS compatibility, please contact a ROHM sales office. ROHM shall have no responsibility for any damages or losses resulting non-compliance with any applicable laws or regulations.
- 12) When providing our Products and technologies contained in this document to other countries, you must abide by the procedures and provisions stipulated in all applicable export laws and regulations, including without limitation the US Export Administration Regulations and the Foreign Exchange and Foreign Trade Act.
- 13) This document, in part or in whole, may not be reprinted or reproduced without prior consent of ROHM.



Thank you for your accessing to ROHM product informations.
More detail product informations and catalogs are available, please contact us.

ROHM Customer Support System

<http://www.rohm.com/contact/>

Mouser Electronics

Authorized Distributor

Click to View Pricing, Inventory, Delivery & Lifecycle Information:

[ROHM Semiconductor:](#)

[BM2P121X-EVK-001](#)