

low resistance flat chip resistors (anti sulfuration)

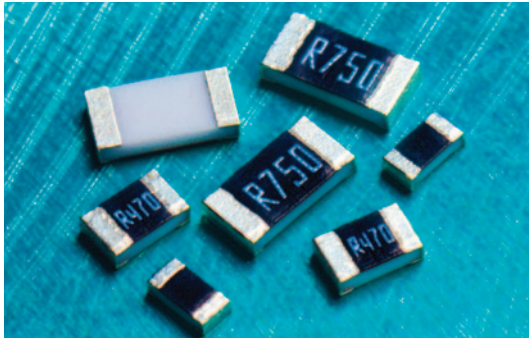

features



- Excellent anti-sulfuration characteristic due to using high sulfuration-proof inner top electrode material
- Current detecting resistors for power supply, motor circuits, etc
- High reliability and performance with resistance tolerance ± 1.0 , T.C.R. $\pm 100 \times 10^{-6}/K$
- Suitable for both reflow and flow solderings
- Products with lead free termination meet EU RoHS requirements. EU RoHS regulation is not intended for Pb-glass contained in electrode, resistor element and glass.
- AEC-Q200 Qualified

dimensions and construction

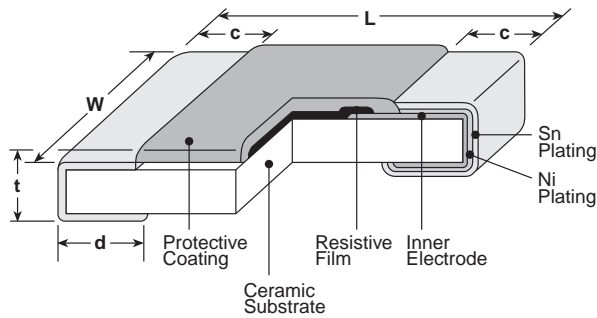

Type (Inch Size Code)	Resistance Range (Ω)	Dimensions inches (mm)				
		L	W	c	d	t
1E (0402)	1 - 10	$.039^{+.004}_{-.002}$ (1.0 ^{+0.1} _{-0.05})	$.020^{+.004}_{-.002}$ (0.5 ^{+0.1} _{-0.05})	$.008 \pm .004$ (0.2 \pm 0.1)	$.010 \pm .004$ (0.25 \pm 0.1)	$.014 \pm .002$ (0.35 \pm 0.05)
1J (0603)	0.1 - 0.43	$.063 \pm .008$ (1.6 \pm 0.2)	$.031^{+.006}_{-.004}$ (0.8 ^{+0.15} _{-0.1})	$.014^{+.006}_{-.004}$ (0.35 ^{+0.15} _{-0.1})	$.014^{+.008}_{-.004}$ (0.35 ^{+0.2} _{-0.1})	$.018 \pm .004$ (0.45 \pm 0.1)
	0.47 - 10			$.014 \pm .004$ (0.35 \pm 0.1)	$.014 \pm .004$ (0.35 \pm 0.1)	
2A (0805)	0.1 - 0.43	$.079 \pm .008$ (2.0 \pm 0.2)	$.049 \pm .004$ (1.25 \pm 0.1)	$.016 \pm .008$ (0.4 \pm 0.2)	$.016^{+.008}_{-.004}$ (0.4 ^{+0.2} _{-0.1})	$.02 \pm .004$ (0.5 \pm 0.1)
	0.47 - 10				$.012^{+.008}_{-.004}$ (0.3 ^{+0.2} _{-0.1})	
2B (1206)	0.1 - 0.43	$.126 \pm .008$ (3.2 \pm 0.2)	$.063 \pm .008$ (1.6 \pm 0.2)	$.02 \pm .012$ (0.5 \pm 0.3)	$.02^{+.008}_{-.004}$ (0.5 ^{+0.2} _{-0.1})	$.024 \pm .004$ (0.6 \pm 0.1)
	0.47 - 10				$.016^{+.008}_{-.004}$ (0.4 ^{+0.2} _{-0.1})	
2E (1210)	0.1 - 0.39	$.126 \pm .008$ (3.2 \pm 0.2)	$.102 \pm .008$ (2.6 \pm 0.2)	$.02 \pm .012$ (0.5 \pm 0.3)	$.02^{+.008}_{-.004}$ (0.5 ^{+0.2} _{-0.1})	$.024 \pm .004$ (0.6 \pm 0.1)
	0.43 - 10				$.016^{+.008}_{-.004}$ (0.4 ^{+0.2} _{-0.1})	

ordering information

SR73	2B	R	T	TD	R10	J
Type	Size	Characteristic	Termination Material	Packaging	Nominal Resistance	Tolerance
	1E 1J 2A 2B 2E	R: Anti-Sulfur	T: Sn	TD: 7" 4mm pitch punch paper TPL, TP: 0402 only, 7" 2mm pitch paper For further information on packaging, please refer to Appendix A	$\pm 2\%$, $\pm 5\%$: 2 significant figures + 1 multiplier "R" indicates decimal on values <10 Ω $\pm 1\%$: 3 significant figures + 1 multiplier "R" indicates decimal on values <100 Ω	F: $\pm 1\%$ G: $\pm 2\%$ J: $\pm 5\%$

applications and ratings

Part Designation	Power Rating	Rated Ambient Temperature	Rated Terminal Part Temp.	T.C.R. (ppm/°C) Max.	Resistance Range			Operating Temperature Range
					F (±1%) E-24, E-96 ¹	G (±2%) E-24	J (±5%) E-24	
SR731ERT (0402)	0.166W	70°C	125°C	±200	1Ω - 10Ω	1Ω - 10Ω	1Ω - 10Ω	-55°C to +155°C
SR731JRT (0603)	0.2W	70°C	125°C	±200	0.2Ω - 10Ω	0.2Ω - 10Ω	0.2Ω - 10Ω	
SR732ART (0805)	0.33W	70°C	125°C	±300	0.1Ω - 0.18Ω	0.1Ω - 0.18Ω	0.1Ω - 0.18Ω	
				±100	0.47Ω - 10Ω	—	—	
				±200	0.2Ω - 0.43Ω	0.2Ω - 10Ω	0.2Ω - 10Ω	
SR732ART (0805)	0.5W ²	70°C	105°C	±250	0.1Ω - 0.18Ω	0.1Ω - 0.18Ω	0.1Ω - 0.18Ω	
				±100	0.47Ω - 10Ω	—	—	
				±200	0.2Ω - 0.43Ω	0.2Ω - 10Ω	0.2Ω - 10Ω	
SR732BRT (1206)	0.33W	70°C	125°C	±250	0.1Ω - 0.18Ω	0.1Ω - 0.18Ω	0.1Ω - 0.18Ω	
				±100	0.47Ω - 10Ω	—	—	
				±200	0.2Ω - 0.43Ω	0.2Ω - 10Ω	0.2Ω - 10Ω	
SR732BRT (1206)	0.5W ²	70°C	110°C	±250	0.1Ω - 0.18Ω	0.1Ω - 0.18Ω	0.1Ω - 0.18Ω	
				±100	0.47Ω - 10Ω	—	—	
				±200	0.2Ω - 0.43Ω	0.2Ω - 10Ω	0.2Ω - 10Ω	
SR732ERT (1210)	0.5W	70°C	125°C	±250	0.1Ω - 0.18Ω	0.1Ω - 0.18Ω	0.1Ω - 0.18Ω	
				±100	0.43Ω - 10Ω	—	—	
				±200	0.2Ω - 0.39Ω	0.2Ω - 10Ω	0.2Ω - 10Ω	
SR732ERT (1210)	0.66W ²	70°C	110°C	±250	0.2Ω - 0.39Ω	0.2Ω - 10Ω	0.2Ω - 10Ω	
				±100	0.43Ω - 10Ω	—	—	
				±200	0.2Ω - 0.39Ω	0.2Ω - 10Ω	0.2Ω - 10Ω	

Rated voltage = $\sqrt{\text{Power rating} \times \text{resistance value}}$ or max. working voltage, whichever is lower

¹ The nominal resistance value for SR731E (1Ω~10Ω), SR731J, 2A, 2B (0.1Ω~0.43Ω) and SR732E (0.1Ω? 0.39Ω) is in E24

² Please use the derating curve based on the terminal part temperature.

If any questions should arise whether to use the "Rated Ambient Temperature" or the "Rated Terminal Part Temperature," please give priority to the "Rated Terminal Part Temperature." Prior to use and for more details refer to "Introduction of the derating curves on the terminal part temperature" in the beginning of the catalog.

Derating Curve

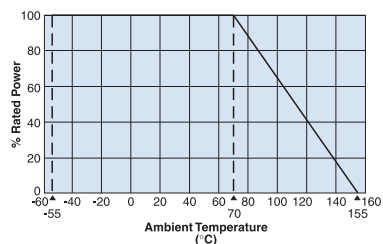

For resistors operated at an ambient temperature of 70°C or above, a power rating shall be derated in accordance with the derating curve.

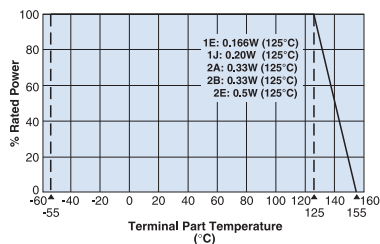

For resistors operated at a terminal part temperature of described for each size or above, a power rating shall be derated in accordance with the derating curve.

Please refer to "Introduction of the derating curve based on the terminal part temperature" in the beginning of our catalog before use.

SR73 2A (0.5W), SR73 2B (0.5W), SR73 2E (0.66W)

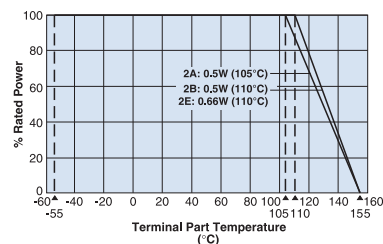

low resistance flat chip resistors (anti sulfuration)

Temperature Rise

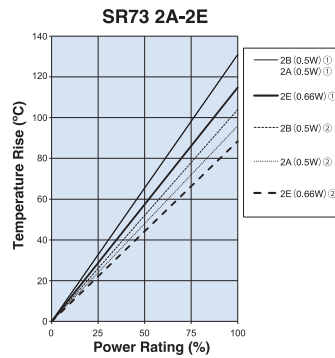
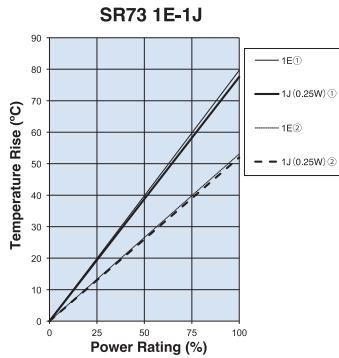

Regarding the temperature rise, the value of the temperature varies per conditions and board for use since the temperature is measured under our measuring conditions.

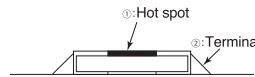

Measurement condition
 Room temperature: 25°C
 PCB: FR-4t = 1.6mm
 Cu foil thickness: 35μm

One-Pulse Limiting Electric Power

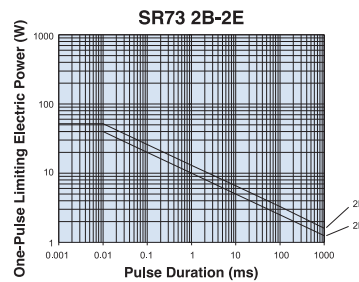
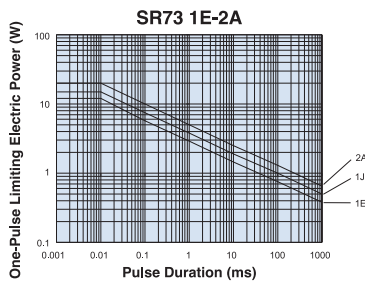

Please ask us about the resistance characteristic of continuous applied pulse. The pulse endurance values are not assured values, so be sure to check the products on actual equipment when you use them.

environmental applications

Performance Characteristics

Parameter	Requirement $\Delta R \pm(\%+0.005\Omega)$		Test Method
	Limit	Typical	
Resistance	Within specified tolerance	—	25°C
T.C.R.	Within specified T.C.R.	—	+25°C/-55°C and +25°C/+125°C
Overload (Short time)	±2%	±0.5%	Rated voltage x 2.5 for 5 seconds
Resistance to Solder Heat	±1%	±0.3%	260°C ± 5°C, 10 seconds ± 1 second
Rapid Change of Temperature	±1%	±0.3%	-55°C (30 minutes) / +125°C (30 minutes), 100 cycles
Moisture Resistance	±2%	±1%	40°C ± 2°C, 90%-95% RH, 1000 hours, 1.5 hr ON, 0.5 hr OFF cycle
Endurance at 70°C	±2%	±1%	70°C ± 2°C or rated terminal part temperature ± 2°C 1000 hours 1.5 hr ON, 0.5 hr OFF cycle
High Temperature Exposure	±1%	±0.3%	+155°C, 1000 hours
Sulfuration Test	±5%	±0.2%	Soaked in industrial oil with sulfur substance 3.5% contained, 105°C ±3°C, 500 hours

Please refer to conventional products for characteristic data such as temperature rise.