

# OSRAM LW Y1SG

## Datasheet

Published by **ams-OSRAM AG**

Tobelbader Strasse 30, 8141 Premstaetten, Austria

Phone +43 3136 500-0

[ams-osram.com](http://ams-osram.com)

© All rights reserved



## Micro SIDELED® 2808

# LW Y1SG

Micro SIDELED is a SMT LED with side emission. Due to its low package height it is ideal for applications in limited space environments.



### Applications

- Access Control & Security
- Appliances & Tools
- Factory Automation
- Home & Building Automation
- Material Processing
- Projection & Display
- Robotics

### Features

- Package: white SMT package, colored diffused silicone resin
- Chip technology: InGaN on Sapphire
- Typ. Radiation: 120° (Lambertian emitter)
- Color:  $C_x = 0.30$ ,  $C_y = 0.28$  acc. to CIE 1931 (● white)
- Optical efficacy: 45 lm/W
- Corrosion Robustness Class: 1B
- ESD: 2 kV acc. to ANSI/ESDA/JEDEC JS-001 (HBM, Class 2)

## Ordering Information

Type	Luminous Intensity <sup>1)</sup> $I_F = 20 \text{ mA}$ $I_v$	Ordering Code
LW Y1SG-BFOO-EKFM-1	$\geq 1600 \text{ mcd}$	Q65111A8461
LW Y1SG-BFOO-GKJM-1	$\geq 1600 \text{ mcd}$	Q65111A8460

## Maximum Ratings

Parameter	Symbol		Values
Operating Temperature	$T_{op}$	min.	-40 °C
		max.	85 °C
Storage Temperature	$T_{stg}$	min.	-40 °C
		max.	100 °C
Junction Temperature	$T_j$	max.	95 °C
Forward current $T_A = 25\text{ °C}$	$I_F$	max.	30 mA
Surge Current $t \leq 10\ \mu\text{s}$ ; $D = 0.005$ ; $T_A = 25\text{ °C}$	$I_{FS}$	max.	300 mA
ESD withstand voltage acc. to ANSI/ESDA/JEDEC JS-001 (HBM, Class 2)	$V_{ESD}$		2 kV
Reverse voltage <sup>2)</sup>	$V_R$		Not designed for reverse operation

## Characteristics

 $I_F = 20 \text{ mA}; T_A = 25 \text{ °C}$ 

Parameter	Symbol		Values
Chromaticity Coordinate <sup>3)</sup>	Cx	typ.	0.30
	Cy	typ.	0.28
Viewing angle at 50% $I_V$	$2\phi$	typ.	120 °
Forward Voltage <sup>4)</sup> $I_F = 20 \text{ mA}$	$V_F$	min.	2.90 V
		typ.	3.30 V
		max.	3.60 V
Reverse current <sup>2)</sup>	$I_R$		Not designed for reverse operation
Temperature Coefficient of Cx	$TC_{C_x}$	typ.	$-0.2 \cdot 10^{-3} / \text{K}$
Temperature Coefficient of Cy	$TC_{C_y}$	typ.	$-0.2 \cdot 10^{-3} / \text{K}$
Real thermal resistance junction/ambient <sup>5)6)</sup>	$R_{thJA \text{ real}}$	max.	460 K / W
Real thermal resistance junction/solderpoint <sup>5)</sup>	$R_{thJS \text{ real}}$	max.	240 K / W

## Brightness Groups

Group	Luminous Intensity <sup>1)</sup> $I_F = 20 \text{ mA}$ min. $I_v$	Luminous Intensity. <sup>1)</sup> $I_F = 20 \text{ mA}$ max. $I_v$	Luminous Flux <sup>7)</sup> $I_F = 20 \text{ mA}$ typ. $\Phi_v$
BF	1600 mcd	1800 mcd	5100 mlm
CE	1800 mcd	2000 mcd	5700 mlm
CF	2000 mcd	2200 mcd	6300 mlm
DE	2200 mcd	2400 mcd	6900 mlm
DF	2400 mcd	2600 mcd	7500 mlm
EE	2600 mcd	2800 mcd	8100 mlm

## Forward Voltage Groups

Group	Forward Voltage <sup>4)</sup> $I_F = 20 \text{ mA}$ min. $V_F$	Forward Voltage <sup>4)</sup> $I_F = 20 \text{ mA}$ max. $V_F$
4	2.90 V	3.20 V
5	3.20 V	3.60 V

### Chromaticity Coordinate Groups

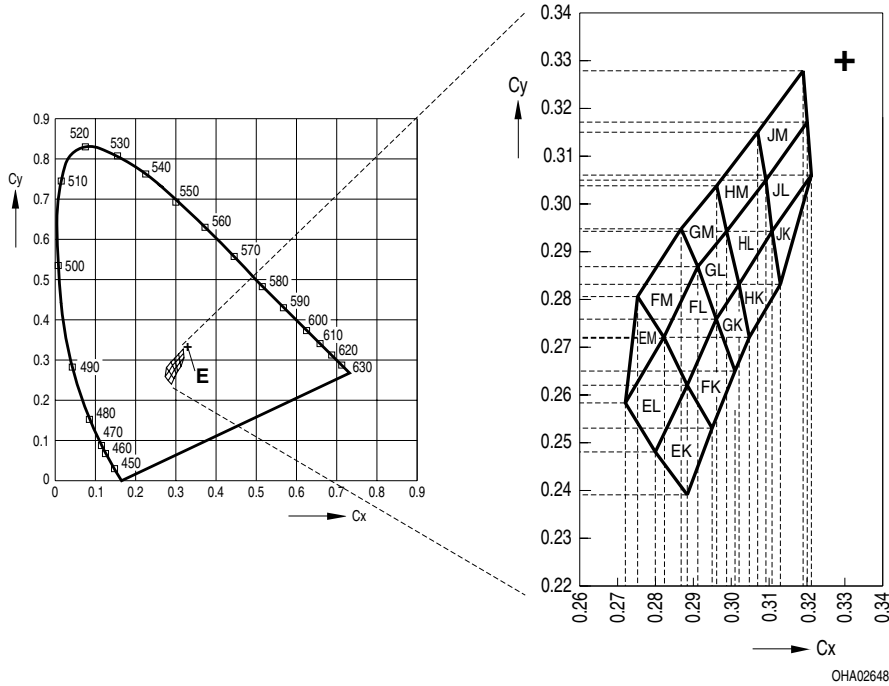

### Chromaticity Coordinate Groups <sup>3)</sup>

Group	Cx	Cy	Group	Cx	Cy	Group	Cx	Cy
EK	0.2880	0.2390	FL	0.2880	0.2620	GM	0.2910	0.2870
	0.2800	0.2480		0.2820	0.2720		0.2870	0.2950
	0.2880	0.2620		0.2910	0.2870		0.2960	0.3040
	0.2950	0.2530		0.2960	0.2760		0.2990	0.2940
EL	0.2800	0.2480	FM	0.2820	0.2720	HK	0.3050	0.2720
	0.2720	0.2580		0.2750	0.2810		0.3020	0.2830
	0.2820	0.2720		0.2870	0.2950		0.3110	0.2940
	0.2880	0.2620		0.2910	0.2870		0.3130	0.2830
EM	0.2720	0.2580	GK	0.3010	0.2650	HL	0.3020	0.2830
	0.2750	0.2810		0.2960	0.2760		0.2990	0.2940
	0.2820	0.2720		0.3020	0.2830		0.3090	0.3050
FK	0.2950	0.2530		0.3050	0.2720		0.3110	0.2940
	0.2880	0.2620	GL	0.2960	0.2760	HM	0.2990	0.2940
	0.2960	0.2760		0.2910	0.2870		0.2960	0.3040
	0.3010	0.2650		0.2990	0.2940		0.3070	0.3150
		0.3020		0.2830	0.3090		0.3050	

Group	Cx	Cy	Group	Cx	Cy	Group	Cx	Cy
JK	0.3130	0.2830	JL	0.3110	0.2940	JM	0.3090	0.3050
	0.3110	0.2940		0.3090	0.3050		0.3070	0.3150
	0.3210	0.3060		0.3200	0.3170		0.3190	0.3280
				0.3210	0.3060		0.3200	0.3170

---

## Group Name on Label

**Example: BF-EK-4**

Brightness	Color Chromaticity	Forward Voltage
BF	EK	4

---

### Relative Spectral Emission <sup>7)</sup>

$I_{rel} = f(\lambda); I_F = 20 \text{ mA}; T_A = 25 \text{ }^\circ\text{C}$

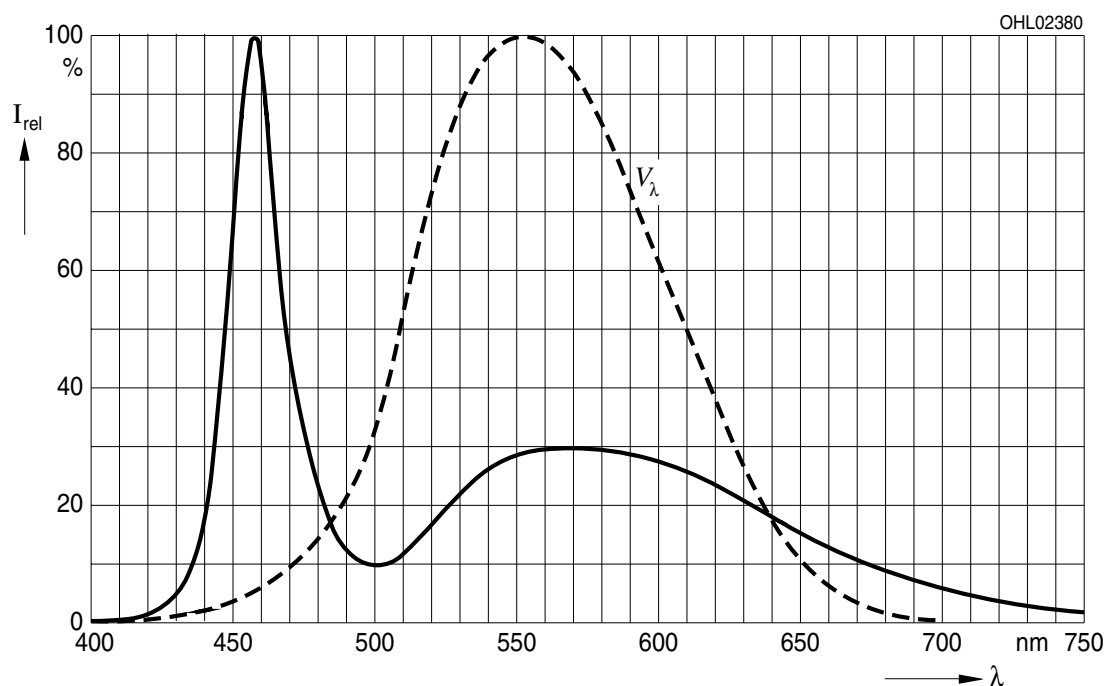

### Radiation Characteristics <sup>7)</sup>

$I_{rel} = f(\phi); T_A = 25 \text{ }^\circ\text{C}$

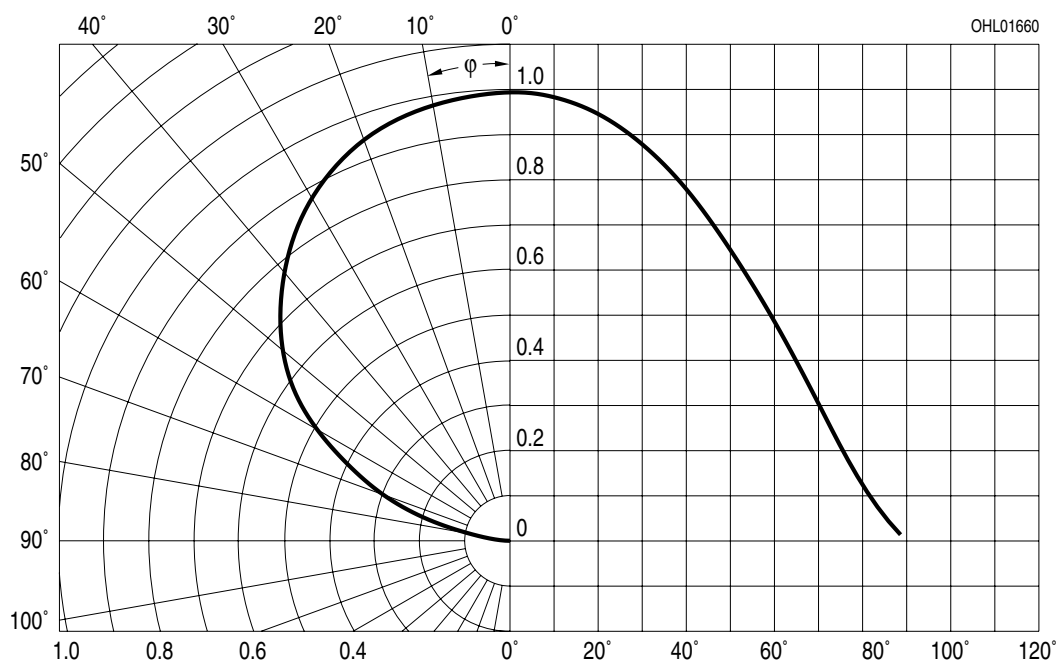

**Forward current** 7), 8)

$I_F = f(V_F); T_A = 25\text{ }^\circ\text{C}$

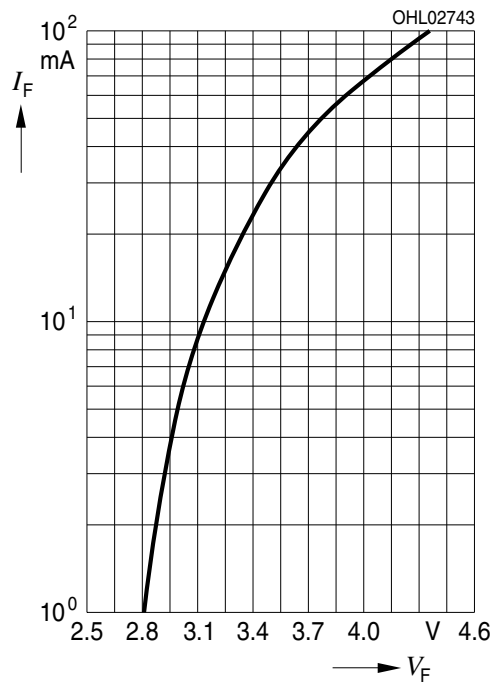

**Relative Luminous Intensity** 7), 8)

$I_V/I_V(20\text{ mA}) = f(I_F); T_A = 25\text{ }^\circ\text{C}$

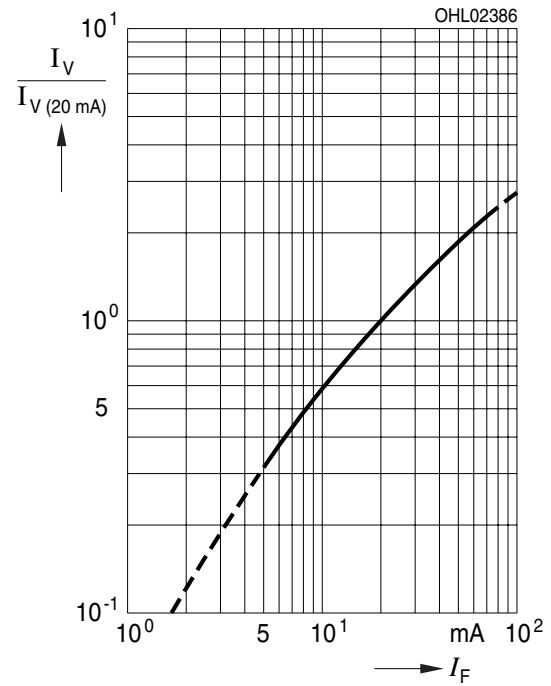

### Forward Voltage <sup>7)</sup>

$$\Delta V_F = V_F - V_F(25\text{ °C}) = f(T_j); I_F = 20\text{ mA}$$

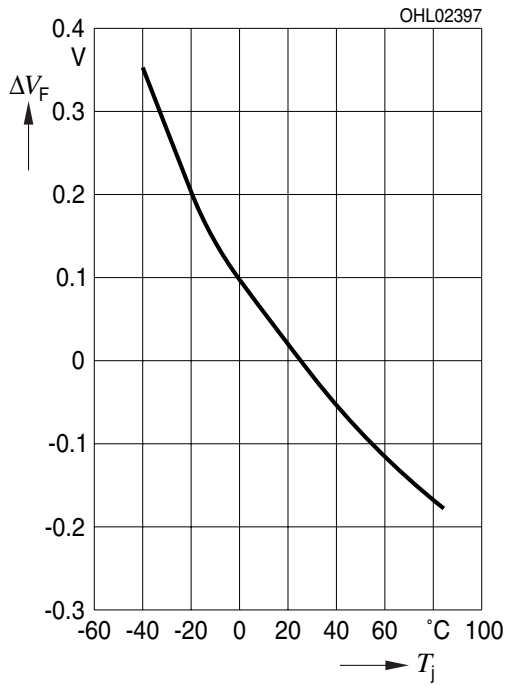

### Relative Luminous Intensity <sup>7)</sup>

$$I_V/I_V(25\text{ °C}) = f(T_j); I_F = 20\text{ mA}$$

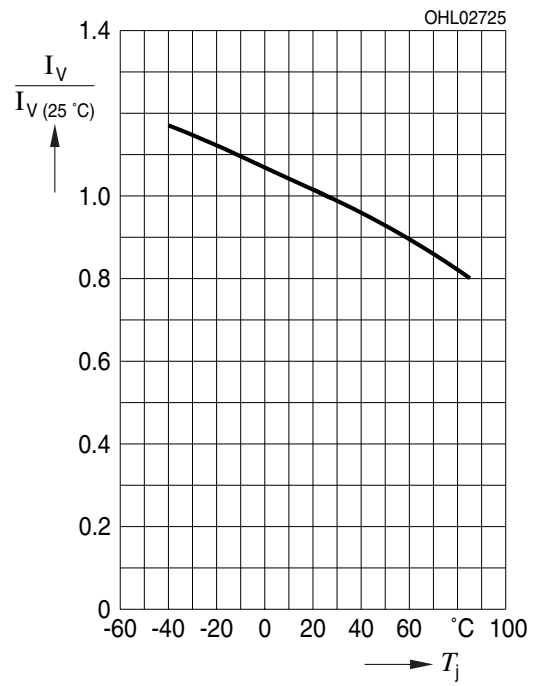

### Max. Permissible Forward Current

$I_F = f(T)$

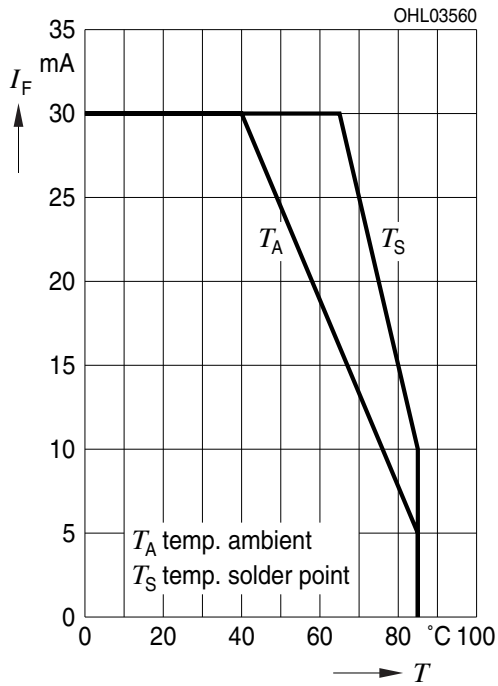

### Permissible Pulse Handling Capability

$I_F = f(t_p)$ ; D: Duty cycle;  $T_A = 25\text{ }^\circ\text{C}$

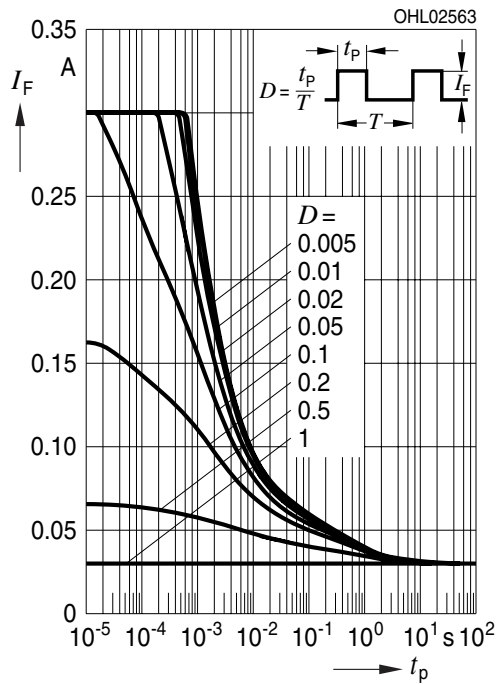

### Permissible Pulse Handling Capability

$I_F = f(t_p)$ ; D: Duty cycle;  $T_A = 85\text{ }^\circ\text{C}$

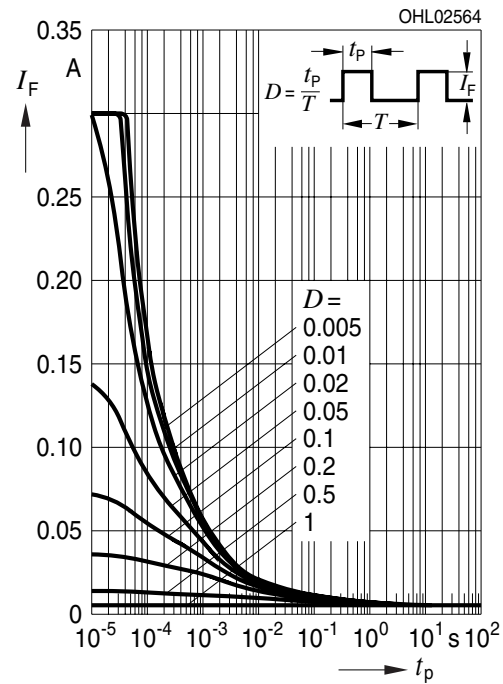

Dimensional Drawing <sup>9)</sup>

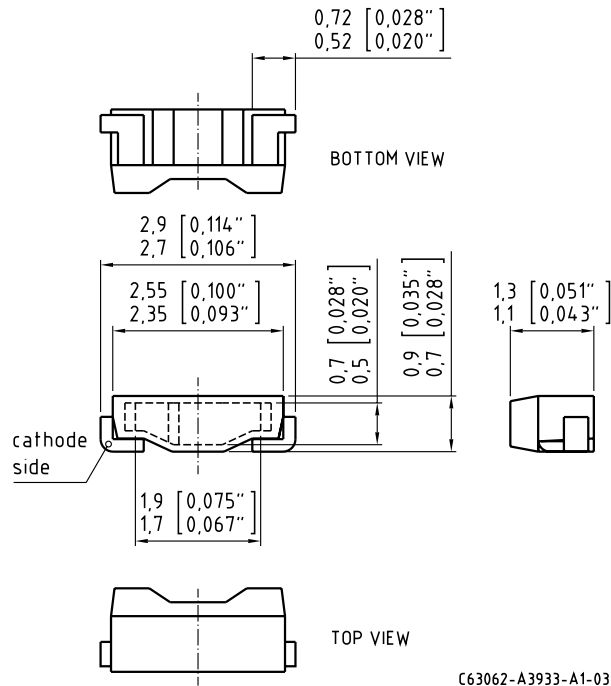

Further Information:

Approximate Weight: 5.0 mg

Corrosion test: Class: 1B  
Test condition: 25°C / 75 % RH / 200ppb SO<sub>2</sub>, 200ppb NO<sub>2</sub>, 10ppb H<sub>2</sub>S, 10ppb Cl<sub>2</sub> / 21 days (EN 60068-2-60 (Method 4))

Recommended Solder Pad <sup>9)</sup>

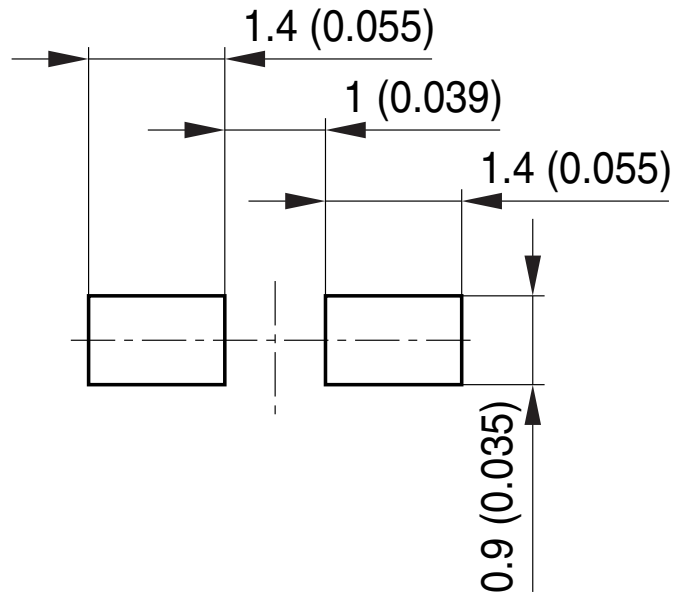

OHLPY944

For superior solder joint connectivity results we recommend soldering under standard nitrogen atmosphere. Package not suitable for ultra sonic cleaning.

### Reflow Soldering Profile

Product complies to MSL Level 4 acc. to JEDEC J-STD-020E

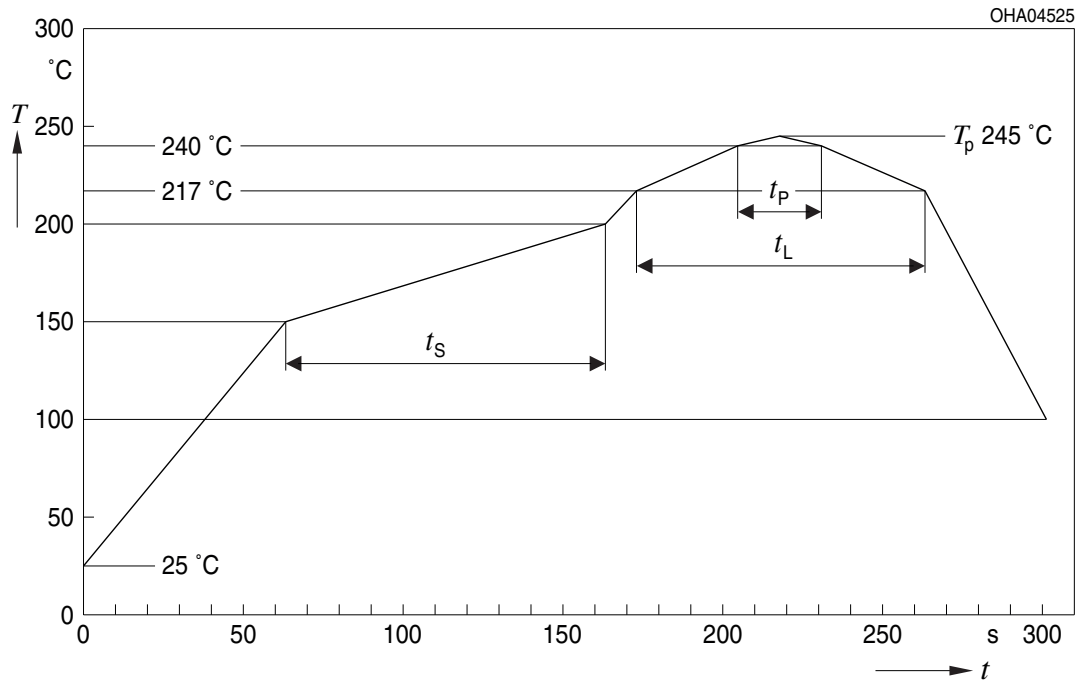

Profile Feature	Symbol	Pb-Free (SnAgCu) Assembly			Unit
		Minimum	Recommendation	Maximum	
Ramp-up rate to preheat <sup>*)</sup> 25 °C to 150 °C			2	3	K/s
Time $t_s$ $T_{Smin}$ to $T_{Smax}$	$t_s$	60	100	120	s
Ramp-up rate to peak <sup>*)</sup> $T_{Smax}$ to $T_p$			2	3	K/s
Liquidus temperature	$T_L$		217		°C
Time above liquidus temperature	$t_L$		80	100	s
Peak temperature	$T_p$		245	260	°C
Time within 5 °C of the specified peak temperature $T_p - 5$ K	$t_p$	10	20	30	s
Ramp-down rate* $T_p$ to 100 °C			3	6	K/s
Time 25 °C to $T_p$				480	s

All temperatures refer to the center of the package, measured on the top of the component  
 \*) slope calculation  $DT/Dt$ :  $Dt$  max. 5 s; fulfillment for the whole T-range

Taping <sup>9)</sup>

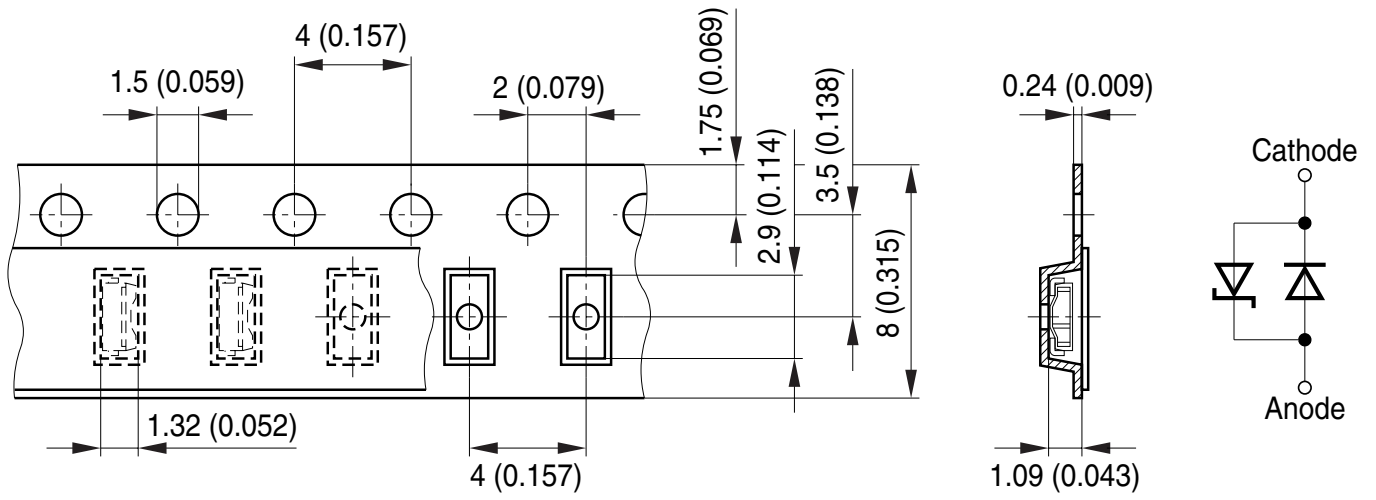

OHAY2128

**Tape and Reel** <sup>10)</sup>

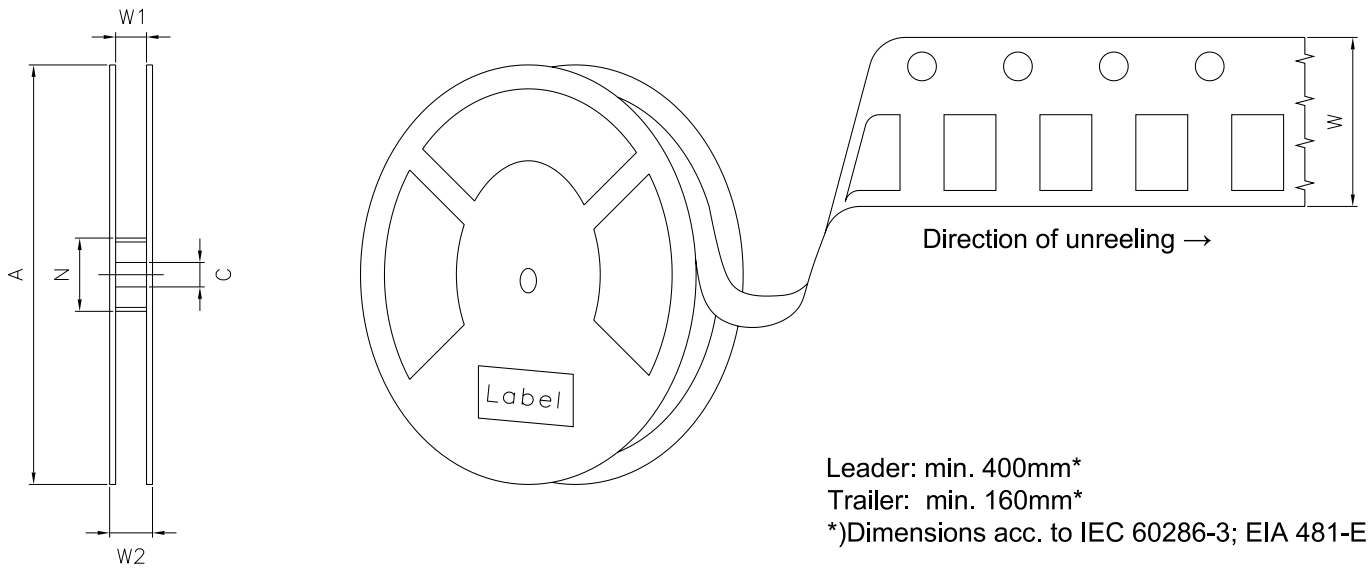

**Reel Dimensions**

A	W	N <sub>min</sub>	W <sub>1</sub>	W <sub>2 max</sub>	Pieces per PU
180 mm	8 + 0.3 / - 0.1 mm	60 mm	8.4 + 2 mm	14.4 mm	2000

### Barcode-Product-Label (BPL)

**OSRAM Opto Semiconductors** LX XXXX BIN1: XX-XX-X-XXX-X

RoHS Compliant

(6P) BATCH NO: 1234567890

(1T) LOT NO: 1234567890 (9D) D/C: 1234

(X) PROD NO: 123456789(Q)QTY: 9999 (G) GROUP: XX-XX-X-X

ML Temp ST  
X XXX °C X

Pack: RXX  
DEMY XXX  
X\_X123\_1234.1234 X

OHA04563

### Dry Packing Process and Materials <sup>9)</sup>

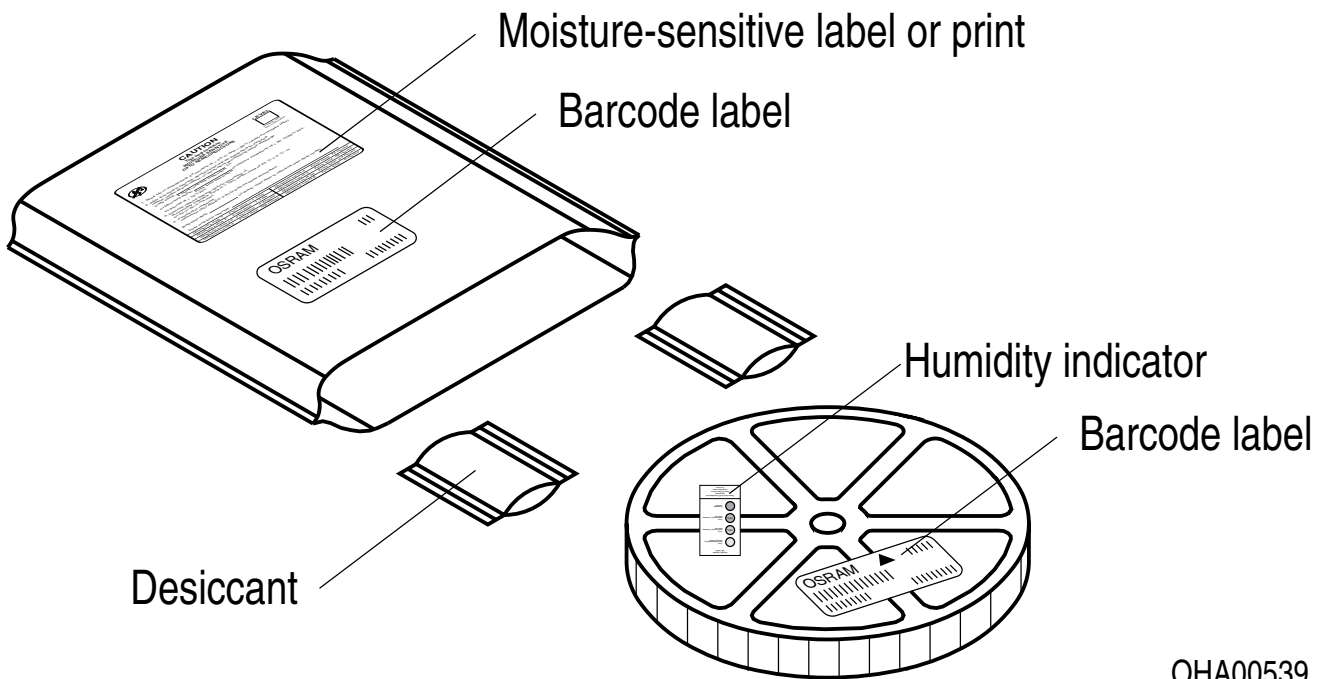

OHA00539

Moisture-sensitive product is packed in a dry bag containing desiccant and a humidity card according JEDEC-STD-033.

---

## Notes

The evaluation of eye safety occurs according to the standard IEC 62471:2006 (photo biological safety of lamps and lamp systems). Within the risk grouping system of this IEC standard, the device specified in this data sheet fall into the class **exempt group (exposure time 10000 s)**. Under real circumstances (for exposure time, conditions of the eye pupils, observation distance), it is assumed that no endangerment to the eye exists from these devices. As a matter of principle, however, it should be mentioned that intense light sources have a high secondary exposure potential due to their blinding effect. When looking at bright light sources (e.g. headlights), temporary reduction in visual acuity and afterimages can occur, leading to irritation, annoyance, visual impairment, and even accidents, depending on the situation.

Subcomponents of this device contain, in addition to other substances, metal filled materials including silver. Metal filled materials can be affected by environments that contain traces of aggressive substances. Therefore, we recommend that customers minimize device exposure to aggressive substances during storage, production, and use. Devices that showed visible discoloration when tested using the described tests above did show no performance deviations within failure limits during the stated test duration. Respective failure limits are described in the IEC60810.

For further application related information please visit [www.osram-os.com/appnotes](http://www.osram-os.com/appnotes)

---

## Disclaimer

### Attention please!

The information describes the type of component and shall not be considered as assured characteristics. Terms of delivery and rights to change design reserved. Due to technical requirements components may contain dangerous substances.

For information on the types in question please contact our Sales Organization.

If printed or downloaded, please find the latest version on our website.

### Packing

Please use the recycling operators known to you. We can also help you – get in touch with your nearest sales office. By agreement we will take packing material back, if it is sorted. You must bear the costs of transport. For packing material that is returned to us unsorted or which we are not obliged to accept, we shall have to invoice you for any costs incurred.

### Product and functional safety devices/applications or medical devices/applications

Our components are not developed, constructed or tested for the application as safety relevant component or for the application in medical devices.

Our products are not qualified at module and system level for such application.

In case buyer – or customer supplied by buyer – considers using our components in product safety devices/ applications or medical devices/applications, buyer and/or customer has to inform our local sales partner immediately and we and buyer and /or customer will analyze and coordinate the customer-specific request between us and buyer and/or customer.

---

## Glossary

- 1) **Brightness:** Brightness groups are tested at a current pulse duration of 25 ms and a tolerance of  $\pm 11\%$ .
- 2) **Reverse Operation:** Not designed for reverse operation. Continuous reverse operation can cause migration and damage of the device.
- 3) **Chromaticity coordinate groups:** Chromaticity coordinate groups are tested at a current pulse duration of 25 ms and a tolerance of  $\pm 0.01$ .
- 4) **Forward Voltage:** Forward voltages are tested at a current pulse duration of 1 ms and a tolerance of  $\pm 0.1$  V.
- 5) **Thermal Resistance:**  $R_{th\ max}$  is based on statistic values ( $6\sigma$ ).
- 6) **Thermal Resistance:**  $R_{thJA}$  results from mounting on PC board FR 4 (pad size 16 mm<sup>2</sup> per pad)
- 7) **Typical Values:** Due to the special conditions of the manufacturing processes of semiconductor devices, the typical data or calculated correlations of technical parameters can only reflect statistical figures. These do not necessarily correspond to the actual parameters of each single product, which could differ from the typical data and calculated correlations or the typical characteristic line. If requested, e.g. because of technical improvements, these typ. data will be changed without any further notice.
- 8) **Characteristic curve:** In the range where the line of the graph is broken, you must expect higher differences between single devices within one packing unit.
- 9) **Tolerance of Measure:** Unless otherwise noted in drawing, tolerances are specified with  $\pm 0.1$  and dimensions are specified in mm.
- 10) **Tape and Reel:** All dimensions and tolerances are specified acc. IEC 60286-3 and specified in mm.

---

## Revision History

Version	Date	Change
1.8	2020-06-04	Schematic Transportation Box Dimensions of Transportation Box
1.9	2022-07-20	New Layout Applications

---



EU RoHS and China RoHS compliant product

此产品符合欧盟 RoHS 指令的要求；  
按照中国的相关法规和标准，  
不含有毒有害物质或元素。

**Published by ams-OSRAM AG**

Tobelbader Strasse 30, 8141 Premstaetten, Austria

Phone +43 3136 500-0

[ams-osram.com](http://ams-osram.com)

© All rights reserved

**am** 

**OSRAM**