

Single line ESD protection for high speed lines in 0402

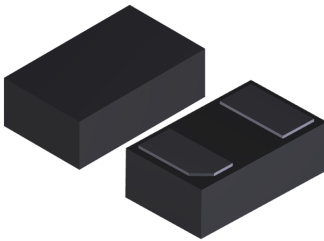

SOD882T(0402)
(QFN-2L 1.0 x 0.6 x 0.35)

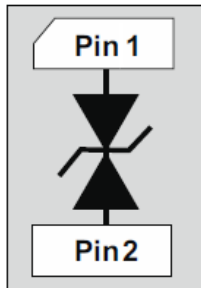

Features

- Flow-through routing to keep signal integrity
- Ultra large bandwidth: 12 GHz
- Ultra low capacitance: 0.4 pF
- Extended operating junction temperature range: -55 °C to 150 °C
- RoHS compliant
- Complies with IEC 61000-4-2 - C = 150 pF, R = 330 Ω
 - ±16 kV (contact discharge)
 - ±30 kV (air discharge)

Application

The ESDAXLC6-1BT2 is a bidirectional single line TVS diode designed to protect the data line or other I/O ports against ESD transients such as:

- Digital video interface
- Ethernet
- USB 2.0 and USB 3.0
- High speed communication buses
- RF front-end

Description

The ESDAXLC6-1BT2 is an ESD device designed for high-speed lines protection.

For automotive application, an AEC-Q101 qualified version is available see ESDAXLC6-1BT2Y.

Product status link

[ESDAXLC6-1BT2](#)

1 Characteristics

Table 1. Absolute maximum ratings ($T_{amb} = 25\text{ }^{\circ}\text{C}$)

Symbol	Parameter		Value	Unit
V_{PP}	Peak pulse voltage	IEC 61000-4-2 (C = 150 pF, R = 330 Ω):		
		Contact discharge	16	kV
		Air discharge	30	
P_{PP}	Peak pulse power dissipation (8/20 μ s)		40	W
I_{PP}	Peak Pulse current (8/20 μ s)		1.3	A
T_{stg}	Storage temperature range		-65 to +150	$^{\circ}\text{C}$
T_j	Operating junction temperature range		-55 to +150	$^{\circ}\text{C}$
T_L	Maximum lead temperature for soldering during 10 s		260	$^{\circ}\text{C}$

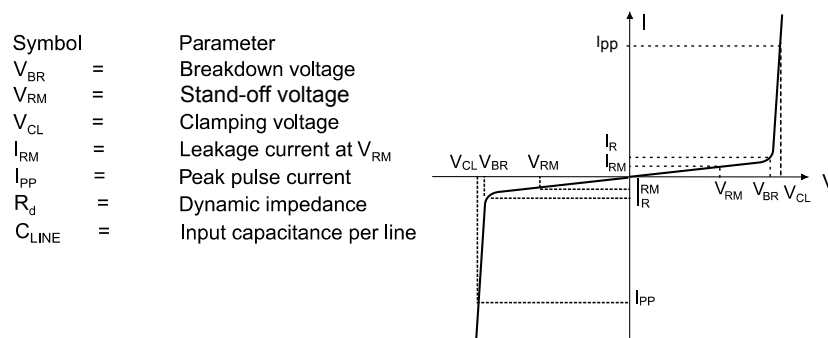
Figure 1. Electrical characteristics (definitions)

Table 2. Electrical characteristics (values) ($T_{amb} = 25\text{ }^{\circ}\text{C}$)

Symbol	Test conditions	Min.	Typ.	Max.	Unit
V_{BR}	$I_R = 1\text{ mA}$	6	9	11	V
I_R	$V_R = 3\text{ V}$			50	nA
V_{CL}	$I_{PP} = 1\text{ A}$, 8/20 μ s			17	V
	IEC 61000-4-2 - C = 150 pF, R = 330 Ω +8 kV contact discharge, measured at 30 ns		37		
	TLP, pulse duration 100 ns, 16 A		41		
R_d	TLP, pulse duration 100 ns, 16 A		2		Ω
$C_{I/O-GND}$	$V_{I/O} = 0\text{ V}$, 200 MHz < f < 3 GHz, $V_{OSC} = 30\text{ mV}$		0.4	0.5	pF
f_C	$S_{21} = -3\text{ dB}$		12		GHz

1.1 Characteristics (curves)

Figure 2. Leakage current versus junction temperature

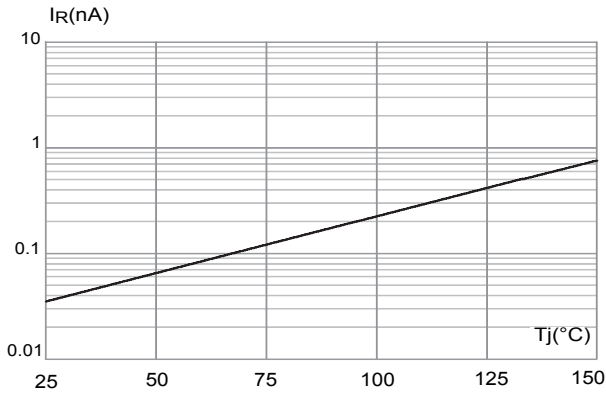

Figure 3. Junction capacitance versus reverse applied voltage

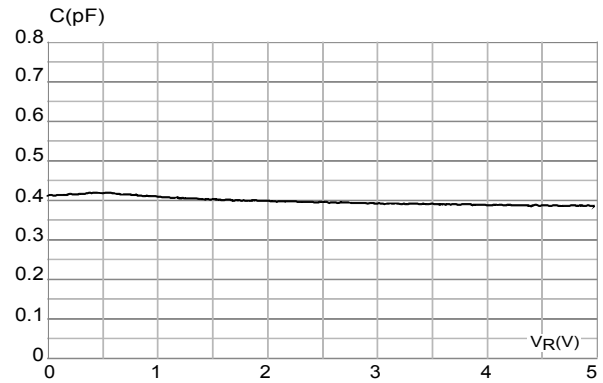

Figure 4. TLP

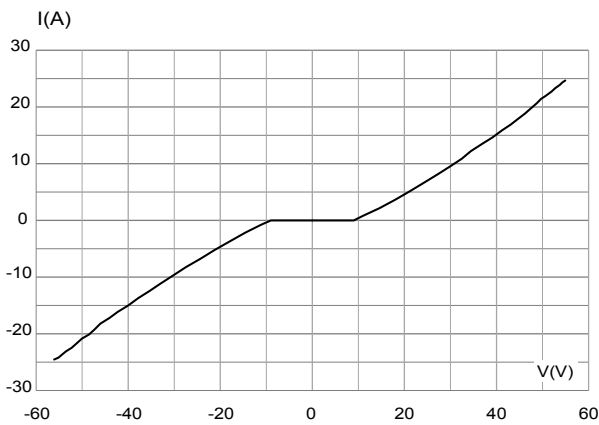

Figure 5. S21 attenuation

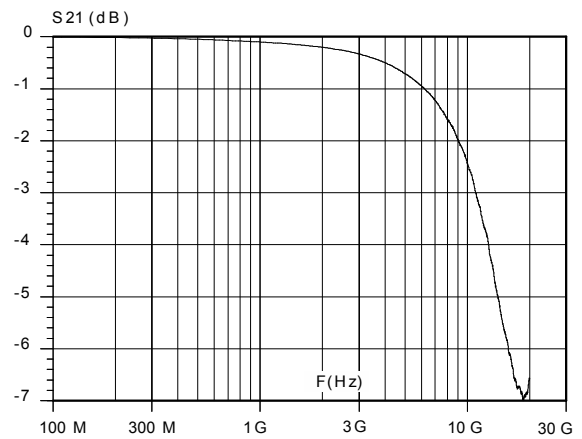

Figure 6. ESD response to IEC 61000-4-2 - C = 150 pF, R = 330 Ω (-8 kV contact discharge)

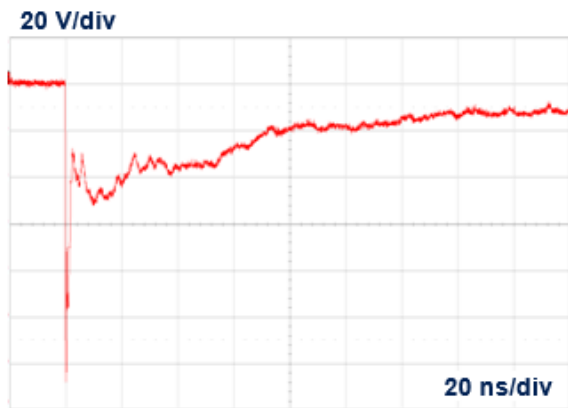

Figure 7. ESD response to IEC 61000-4-2 - C = 150 pF, R = 330 Ω (+8 kV contact discharge)

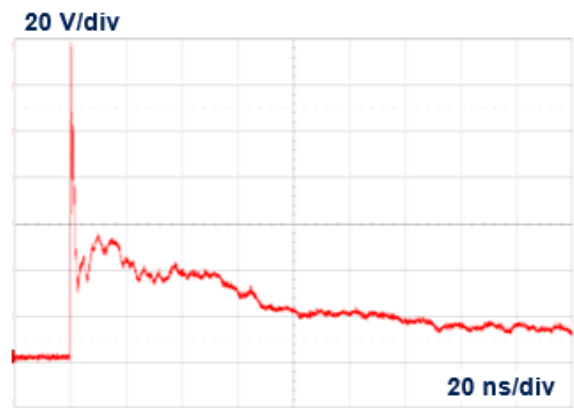

Figure 8. H2 harmonic versus input power at 710 MHz

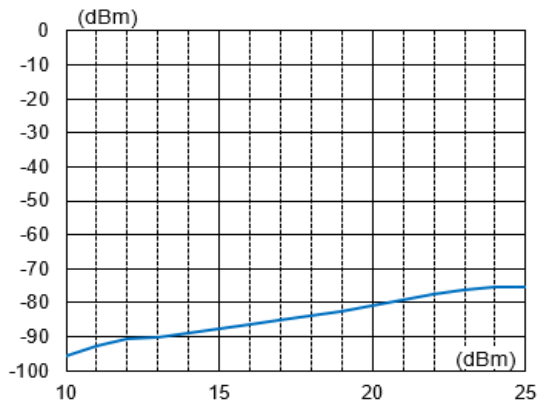

Figure 9. H3 harmonic versus input power at 710 MHz

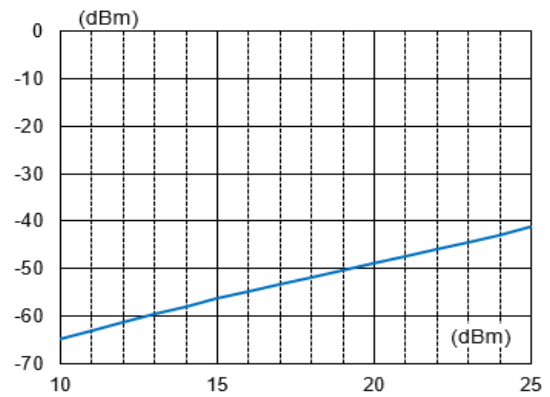

Figure 10. H2 harmonic versus input power at 824 MHz

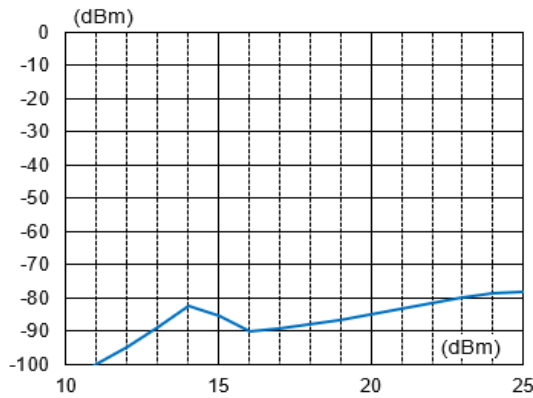

Figure 11. H3 harmonic versus input power at 824 MHz

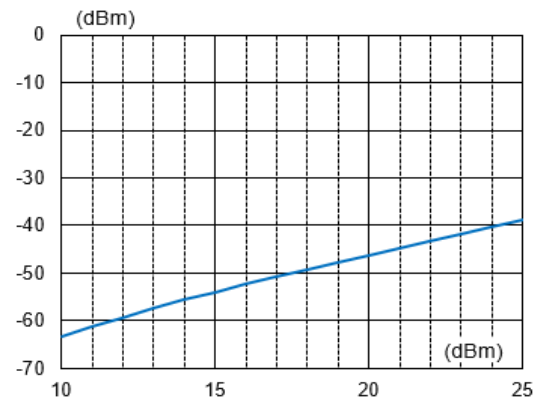

Figure 12. H2 harmonic versus input power at 2400 MHz

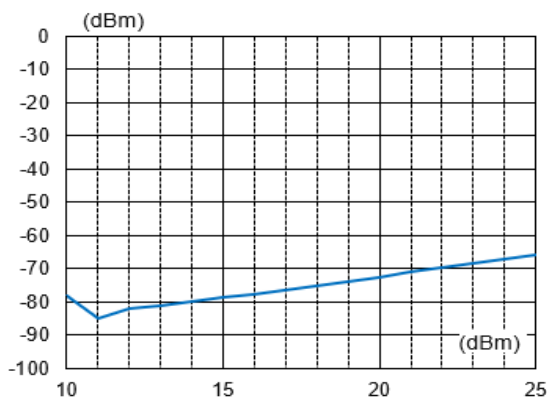
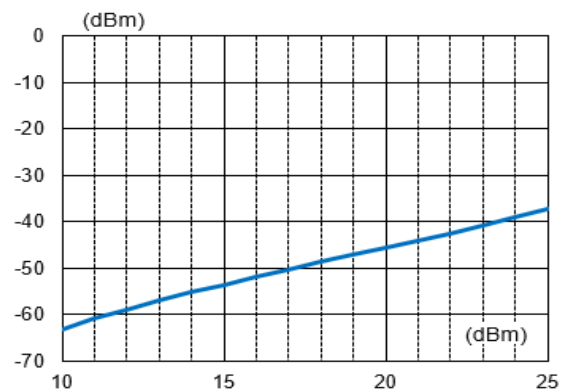

Figure 13. H3 harmonic versus input power at 2400 MHz



2 Package information

In order to meet environmental requirements, ST offers these devices in different grades of **ECOPACK** packages, depending on their level of environmental compliance. ECOPACK specifications, grade definitions and product status are available at: www.st.com. ECOPACK is an ST trademark.

2.1 Package information

Figure 14. Package outline

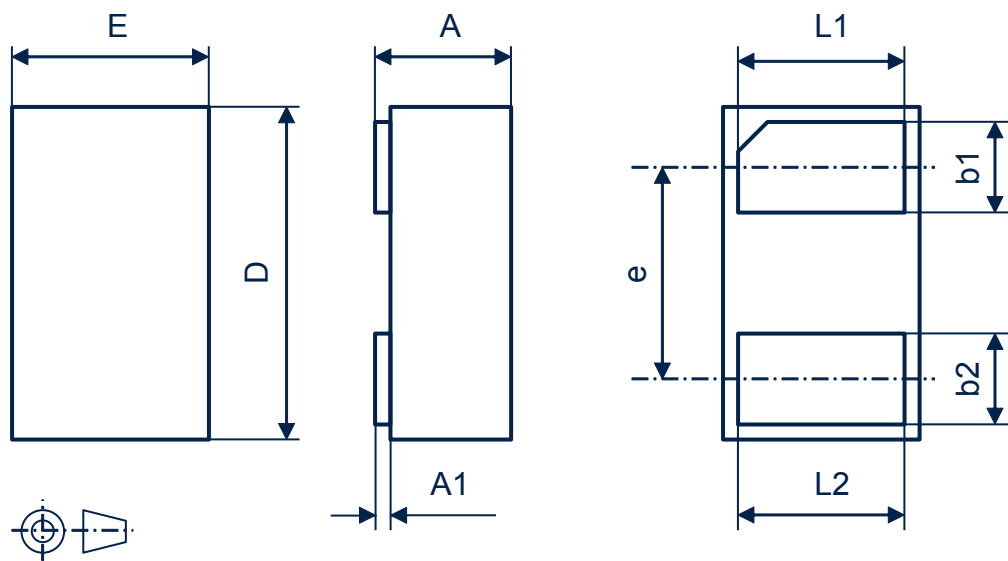
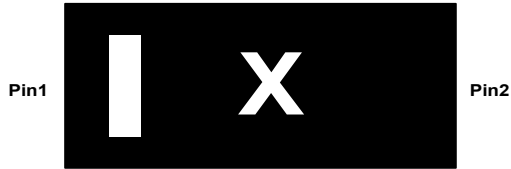

Table 3. Package mechanical data

Ref.	Dimensions		
	Millimeters		
	Min.	Typ.	Max.
A	0.30		0.40
A1	0.00		0.05
L1	0.45	0.50	0.55
L2	0.45	0.50	0.55
D	0.95	1.00	1.05
E	0.55	0.60	0.65
e	0.60	0.65	0.70
b1	0.20	0.25	0.30
b2	0.20	0.25	0.30

2.2 Packing and marking information

Figure 15. Marking layout



X: Refer to ordering information table for marking.

Figure 16. Package orientation in reel

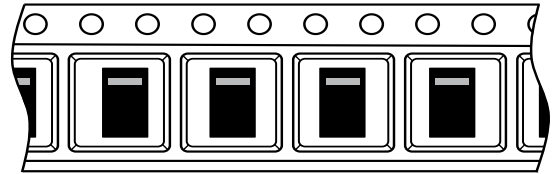

Taped according to EIA-481

Note: Pocket dimensions are not on scale
Pocket shape may vary depending on package
On bidirectional devices, marking and logo may be not always in the same direction

Figure 17. Tape leader and trailer dimensions

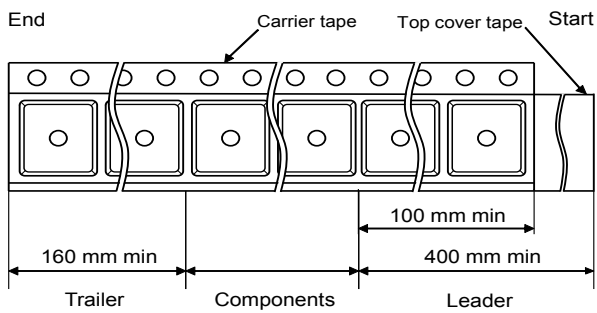

Figure 18. Tape and reel orientation

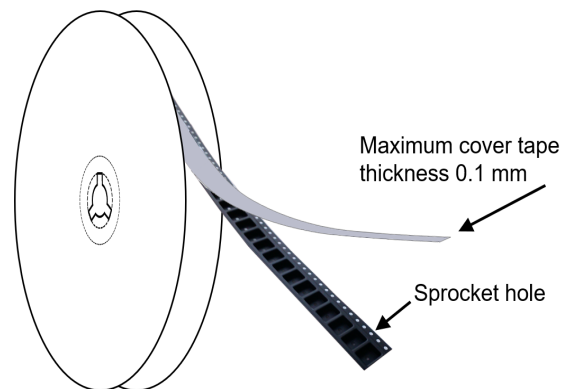

Figure 19. Reel dimensions (mm)

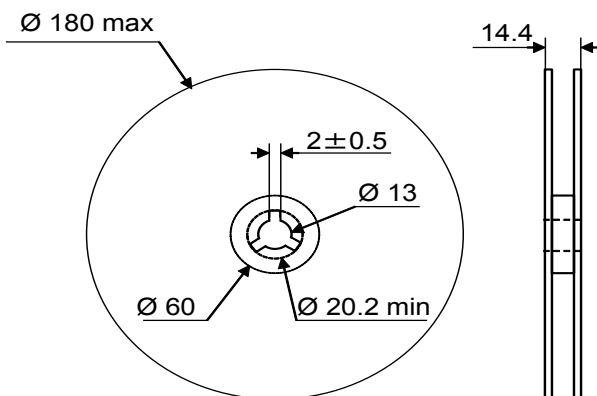

Figure 20. Inner box dimensions (mm)

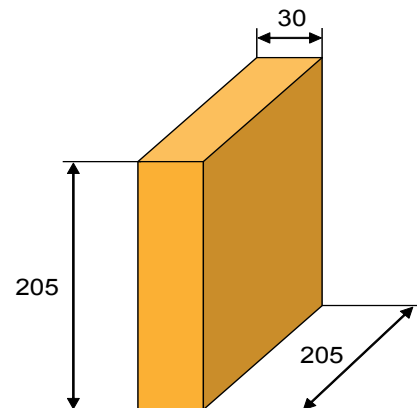
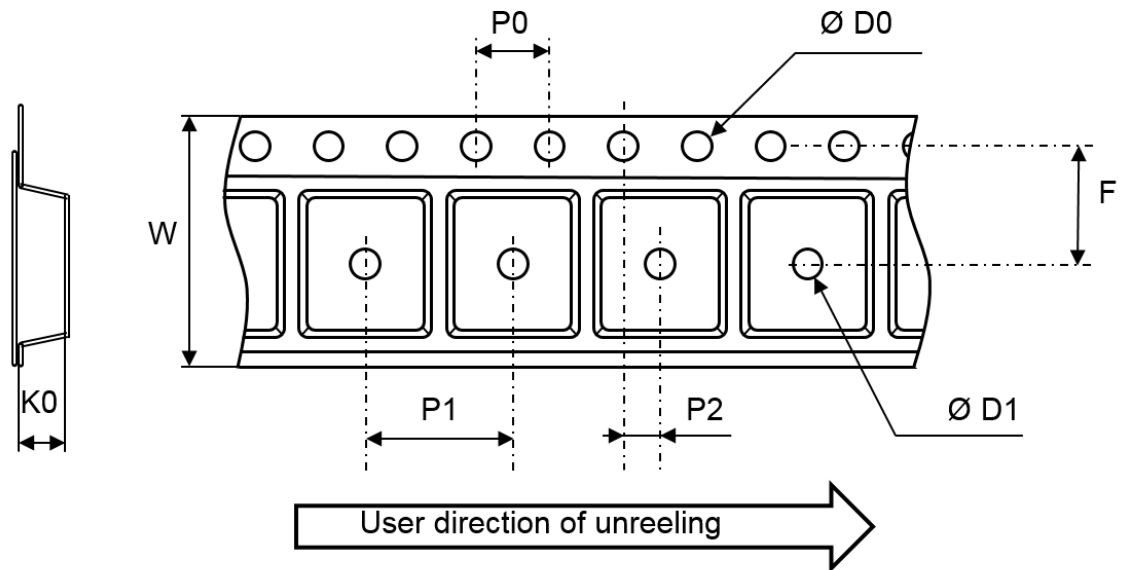

Figure 21. Tape outline



Note: Pocket dimensions are not on scale
Pocket shape may vary depending on package

Table 4. Tape and reel mechanical data

Ref.	Dimensions		
	Millimeters		
	Min.	Typ.	Max.
D0	1.45	1.5	1.6
D1	0.35		
F	3.45	3.5	3.55
K0	0.42	0.47	0.52
P0	3.9	4	4.1
P1	1.95	2	2.05
P2	1.95	2	2.05
W	7.9	8	8.3

3 Assembly recommendations

3.1 Recommended footprint

Figure 22. Recommended footprint in mm

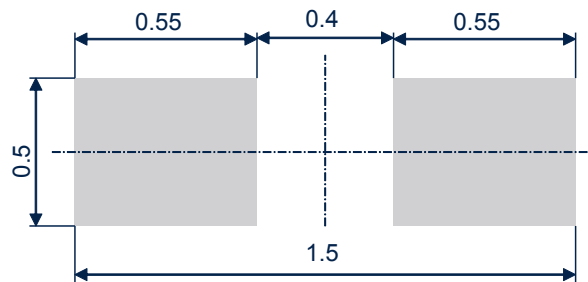

Note: Solder mask defined (SMD) recommended.

3.2 Stencil opening design

Stencil opening thickness: 75 μm / 3 mils

Figure 23. Stencil opening recommendations

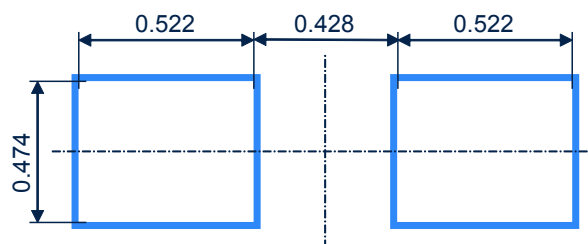

3.3 Solder paste

1. Halide-free flux, qualification ROL0 according to ANSI/J-STD-004.
2. "No clean" solder paste recommended.
3. Tack force high enough to resist component displacement during PCB movement.
4. Particles size 20-38 μm per IPCJ STD-005.

3.4 Placement

1. It is recommended to use leads recognition instead of package outline for accurate placement on footprint with adequate resolution tool.
2. Tolerance of $\pm 50 \mu\text{m}$ (25% offset allowed on the smallest dimension of the smallest pad) is recommended.
3. 1.0 N placement force is recommended. Too much placement force can lead to squeezed out solder paste and cause solder joints to short. Too low placement force can lead to insufficient contact between package and solder paste that could cause open solder joints or badly centered packages.
4. For assembly, a perfect supporting of the PCB (all the more on flexible PCB) is recommended during solder paste printing, pick and place and reflow soldering by using optimized tools.

3.5 PCB design preference

1. Any via around or inside the footprint area must be closed to avoid solderpaste migration in the via.
2. Position and dimensions of the tracks should be well balanced. A symmetrical layout is recommended to prevent assembly troubles.

3.6 Reflow profile

Figure 24. ST ECOPACK recommended soldering reflow profile for PCB mounting

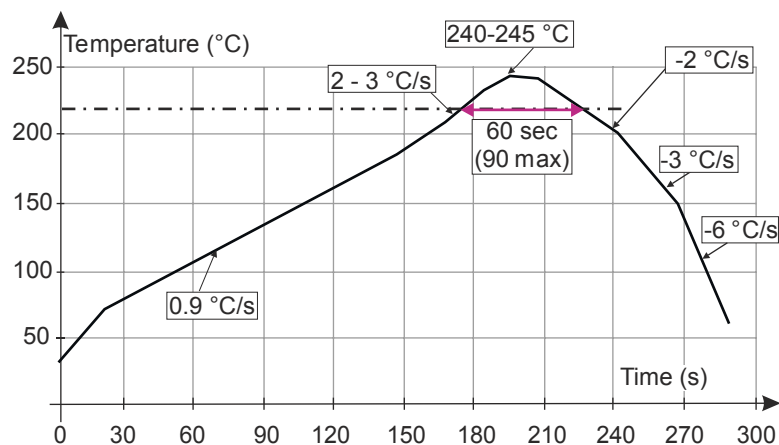

Note: Minimize air convection currents in the reflow oven to avoid component movement. O_2 rate inside the oven must be below 500 ppm. Maximum soldering profile corresponds to the latest IPC/JEDEC J-STD-020.

4 Ordering information

Figure 25. Ordering information scheme

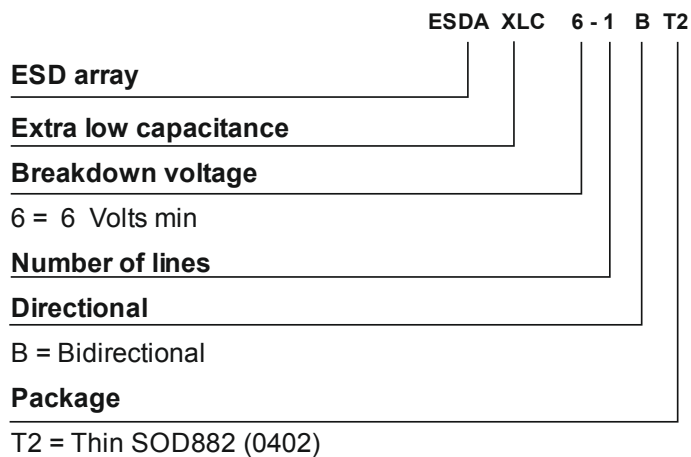

Table 5. Ordering information

Order code	Marking ⁽¹⁾	Package	Weight	Base qty.	Delivery mode
ESDAXLC6-1BT2	T	SOD882T (0402)	0.80 mg	12000	Tape and reel

1. The marking can be rotated by multiples of 90° to differentiate assembly location

Revision history

Table 6. Document revision history

Date	Version	Changes
04-Sep-2012	1	Initial release.
12-Aug-2013	2	Updated Figure 4, Figure 5, Figure 6, Figure 11 and Table 4.
10-May-2021	3	Updated SOD882T (0402) package information. Minor text changes.

IMPORTANT NOTICE – PLEASE READ CAREFULLY

STMicroelectronics NV and its subsidiaries (“ST”) reserve the right to make changes, corrections, enhancements, modifications, and improvements to ST products and/or to this document at any time without notice. Purchasers should obtain the latest relevant information on ST products before placing orders. ST products are sold pursuant to ST’s terms and conditions of sale in place at the time of order acknowledgement.

Purchasers are solely responsible for the choice, selection, and use of ST products and ST assumes no liability for application assistance or the design of Purchasers’ products.

No license, express or implied, to any intellectual property right is granted by ST herein.

Resale of ST products with provisions different from the information set forth herein shall void any warranty granted by ST for such product.

ST and the ST logo are trademarks of ST. For additional information about ST trademarks, please refer to www.st.com/trademarks. All other product or service names are the property of their respective owners.

Information in this document supersedes and replaces information previously supplied in any prior versions of this document.

© 2021 STMicroelectronics – All rights reserved