

CL1208

Multi-phase power inductors



Product features

- High current multi-phase inductor
- 100 nH per phase coupled inductor
- 12 mm wide x 8.5 mm high footprint surface mount package with 12.5 mm, 18.5 mm, 24.5 mm and 36.5 mm lengths
- Ferrite core material
- Moisture Sensitivity Level (MSL): 1

Applications

- For exclusive use with Maxim® Multi-phase controllers
- Voltage Regulator Modules (VRMs) and high power density VRMs
 - Server and desktop
 - Central processing unit (CPU)
 - Graphics processing unit (GPU)
 - Application specific integrated circuit (ASIC)
- Data networking and storage systems
- High current Point-of-Load (POL) modules
- Vcore regulators

Environmental data

- Storage temperature range (Component): -40 °C to +125 °C
- Operating temperature range: -40 °C to +125 °C (ambient plus self-temperature rise)
- Solder reflow temperature: J-STD-020 (latest revision) compliant



Maxim® is a registered trademark of Maxim Integrated Devices, Inc.

Product specifications

Part Number ⁵	Inductor Phases	OCL ¹ (nH) typical	OCL ¹ (nH) minimum	FLL ² (nH) minimum	I _{sat} ¹ (A)	DCR (mΩ) maximum @ +20 °C	SCL ³ (nH) ±20%	I _{sat} ² (A)
CL1208-2-100TR-R	2	400	360	320	15	0.45	100	56
CL1208-3-100TR-R	3	400	360	320	15	0.45	100	56
CL1208-4-100TR-R	4	400	360	320	15	0.45	100	56
CL1208-6-100TR-R	6	400	360	320	15	0.45	100	56

- Open Circuit Inductance (OCL) Test Parameters: 1.0 MHz, 0.1 V_{rms}, 0.0 Adc, +105 °C
- Full Load Inductance (FLL) Test Parameters: 1.0 MHz, 0.1 V_{rms}, I_{sat}¹, +105 °C
- Short Circuit Inductance (SCL) Test Parameters: 1.0 MHz, 0.1 V_{rms}, 0.0 Adc, +105 °C
CL1208-2-100TR-R short (1 & 4), measure (2 & 3), and divide by 2
CL1208-3-100TR-R short (1 & 4), (3 & 6), measure (2 & 5), and divide by 3
CL1208-4-100TR-R short (1 & 4), (3 & 6), (5 & 8) measure (2 & 7), and divide by 4
CL1208-6-100TR-R short (1 & 4), (3 & 6), (5 & 8), (7 & 10), (9 & 12) measure (2 & 11), and divide by 6
- I_{sat}²: Peak current where SCL drops approximately 20% @ +105 °C

- Part Number Definition: CL1208-x-100TR-R
CL1208 = Product code and size
x= Number of phases
100= Inductance value per phase in nH
TR= Tape and reel packaging
-R suffix = RoHS compliant

Note: This device is licensed for use only when incorporated within a voltage regulator employing power regulating devices manufactured by Maxim Integrated Devices, Inc. No license is granted expressly or by implication to use this device with power regulating devices manufactured by any company other than Maxim.

Dimensions (mm)

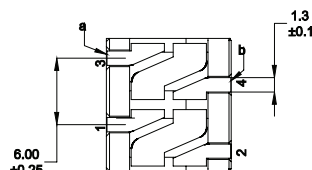
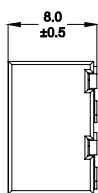
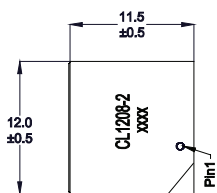

Recommended Pad Layout

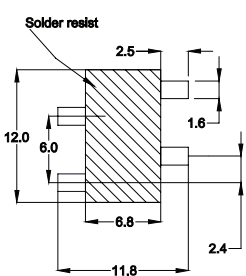

Schematic

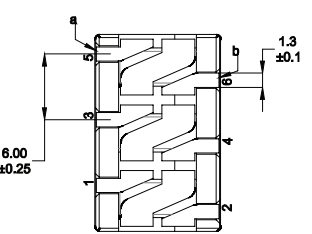
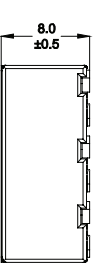
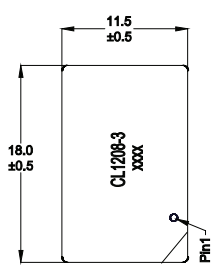
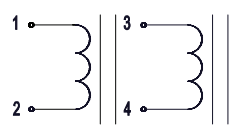

Recommended Pad Layout

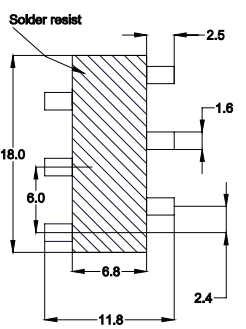

Schematic

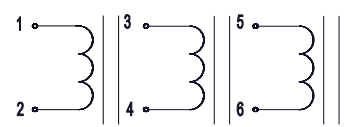

Part marking: CL1208-x-100TR-R (x = number of phases), xxxx = lot code
Tolerances are ±0.25 millimeters unless stated otherwise
All soldering surfaces to be coplanar within 0.13 millimeters
PCB tolerances are ±0.1 millimeters unless stated otherwise
DCR measured from point "a" to point "b"
Do not route traces or vias underneath the inductor

Dimensions (mm)

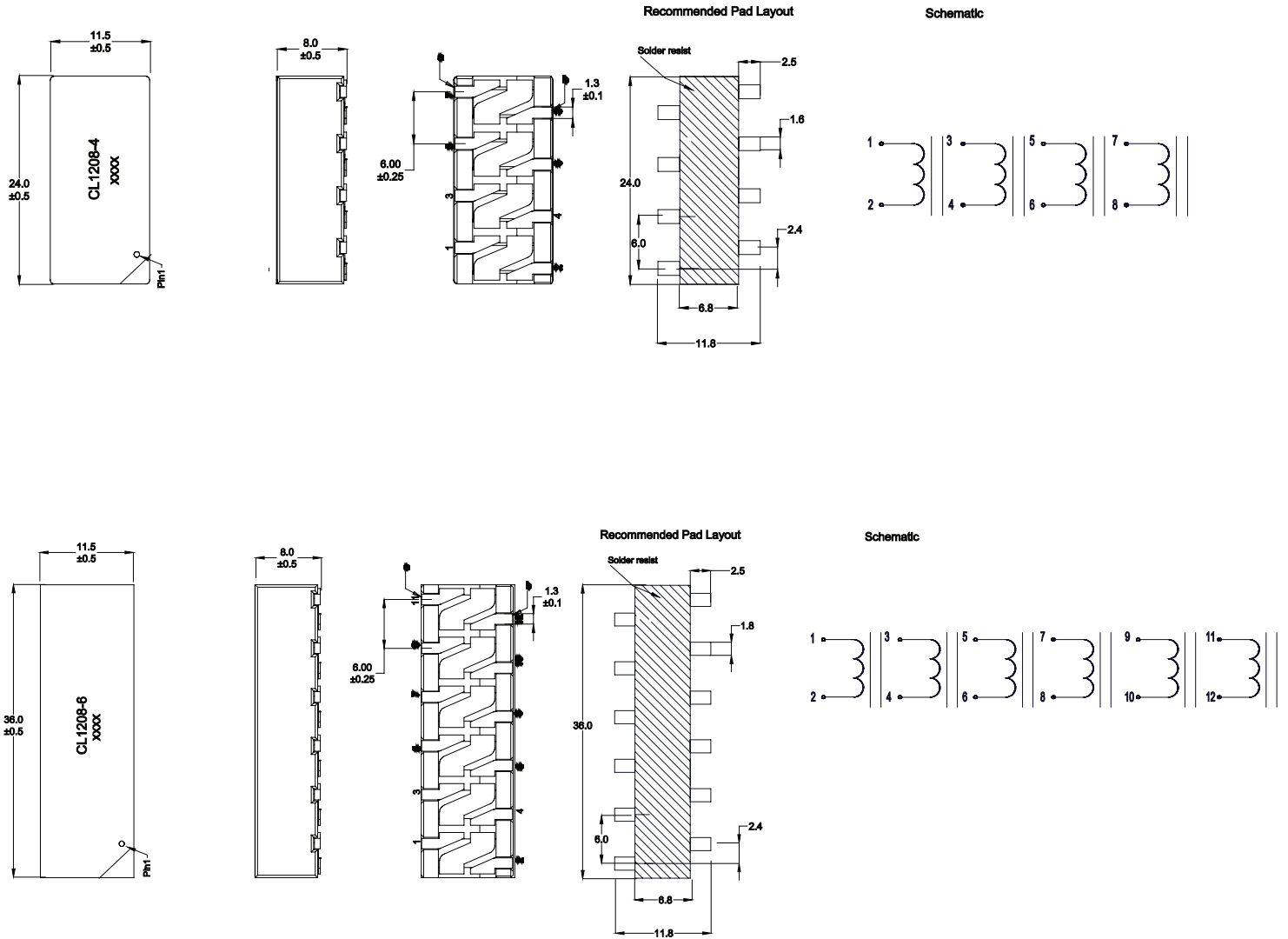

Part marking: CL1208-x100TR-R (x = number of phases), xxxx = lot code
 Tolerances are ±0.25 millimeters unless stated otherwise
 All soldering surfaces to be coplanar within 0.13 millimeters
 PCB tolerances are ±0.1 millimeters unless stated otherwise
 DCR measured from point "a" to point "b"
 Do not route traces or vias underneath the inductor

Packaging information (mm)

Supplied in tape and reel packaging on a 13" diameter reel

Drawing not to scale

CL1208-2-100TR-R

300 parts per reel

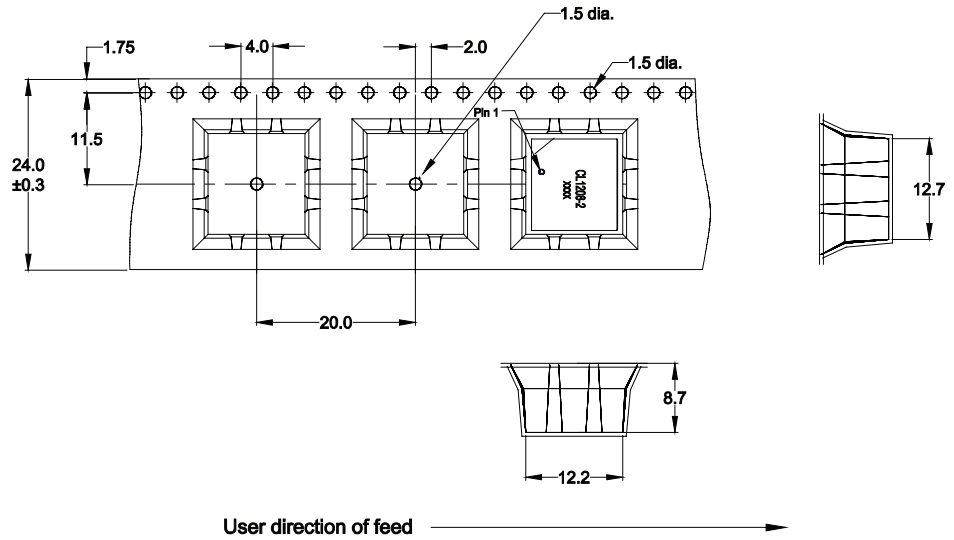

CL1208-3-100TR-R

300 parts per reel

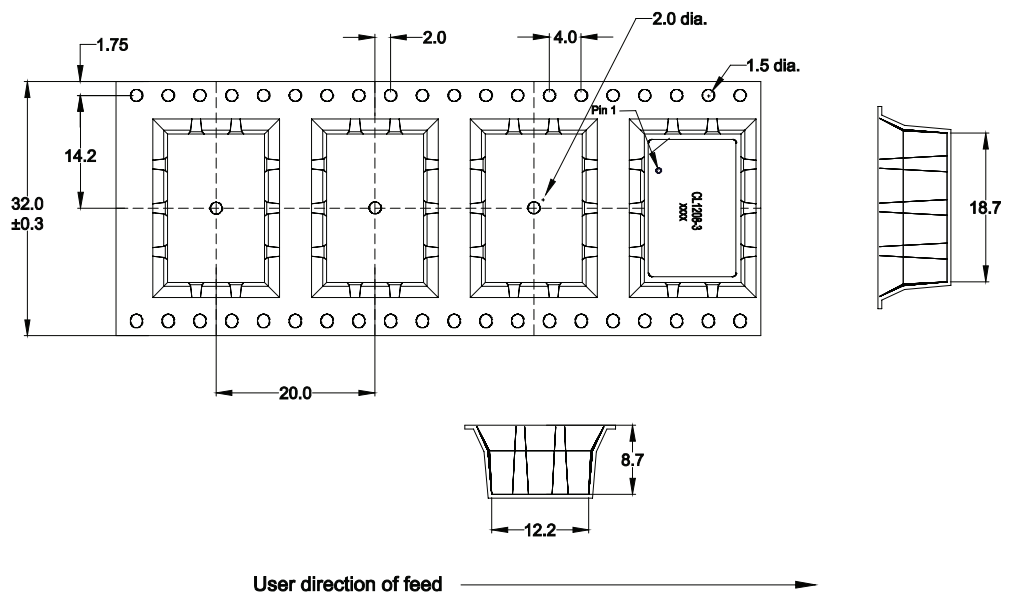

Packaging information (mm)

Supplied in tape and reel packaging on a 13" diameter reel

Drawing not to scale

CL1208-4-100TR-R

200 parts per reel

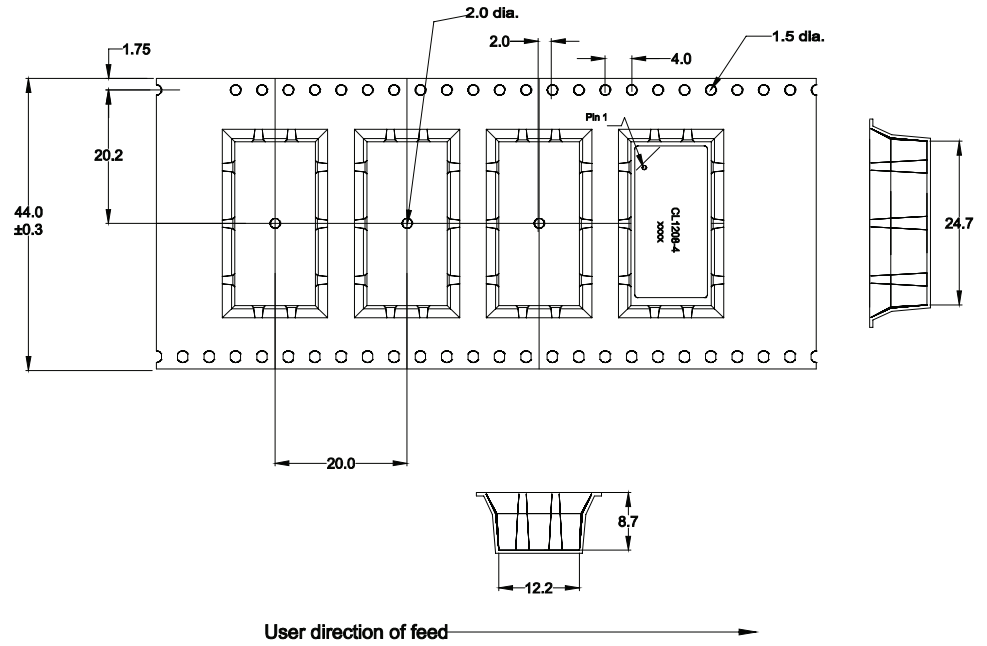

CL1208-6-100TR-R

200 parts per reel

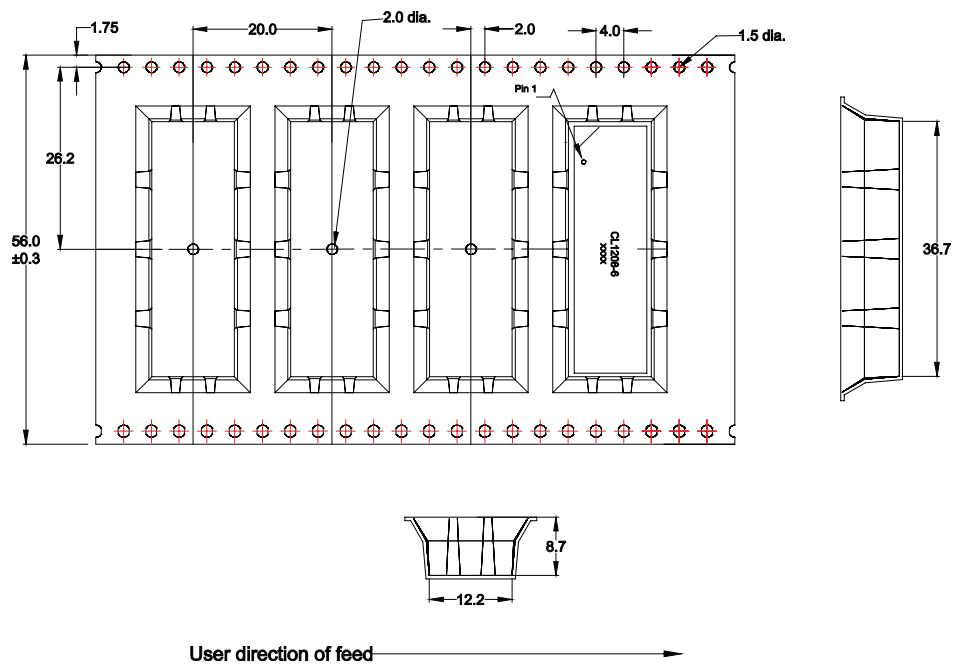

Inductance characteristics – SCL vs. current

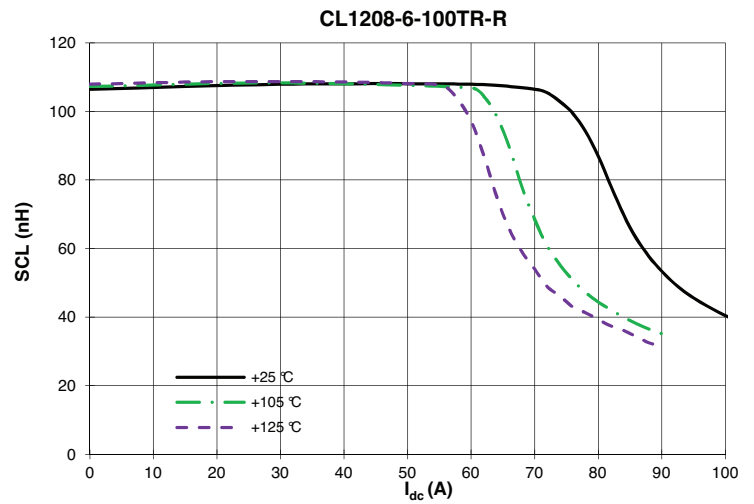
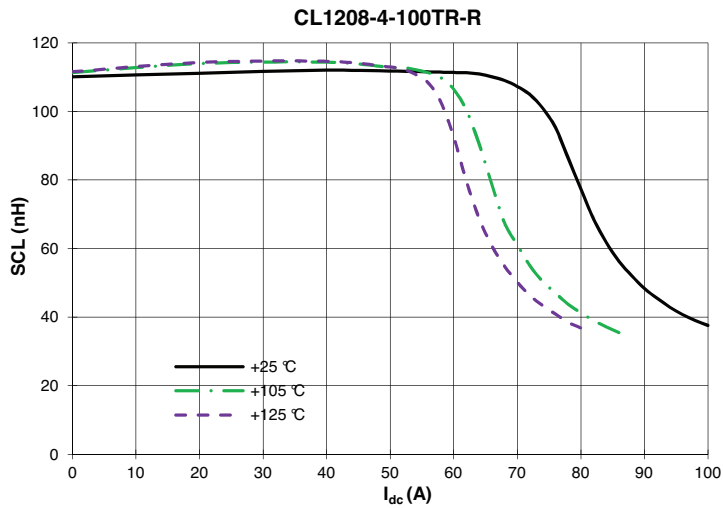
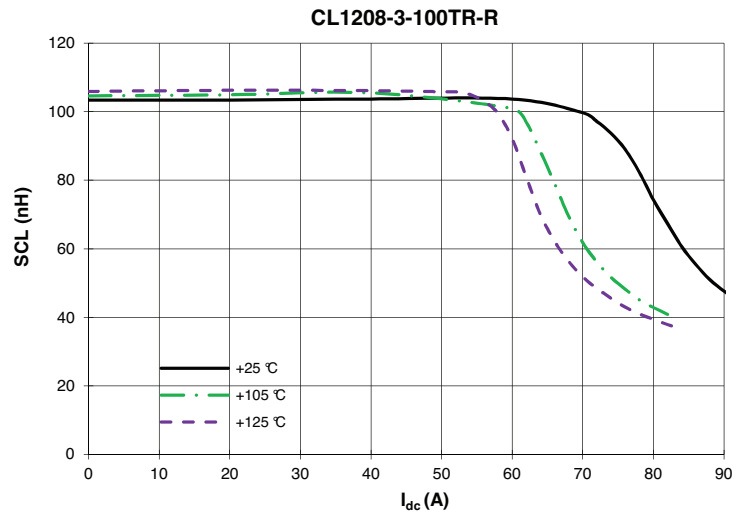
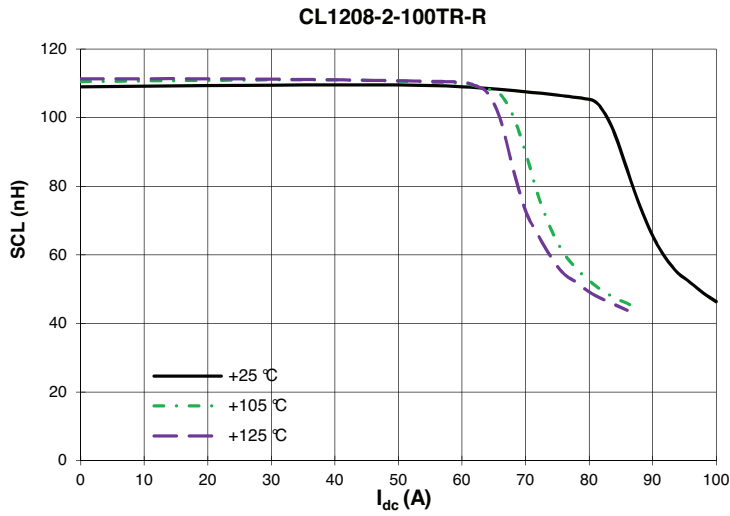

Inductance characteristics – OCL vs. current

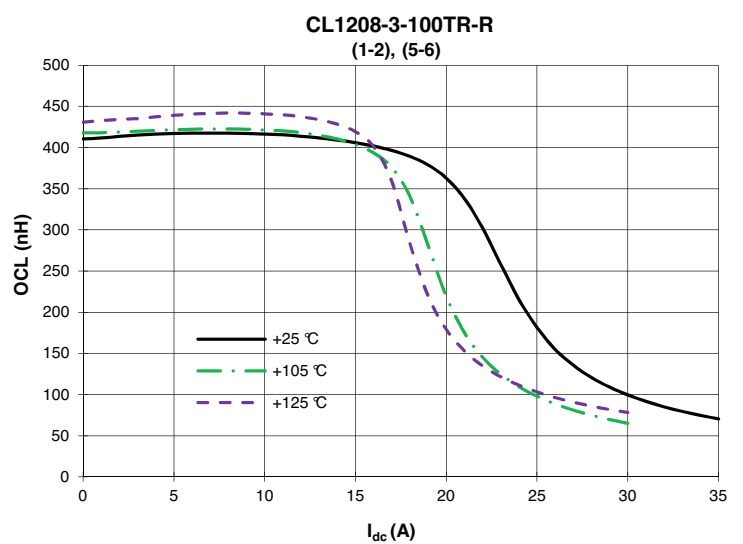
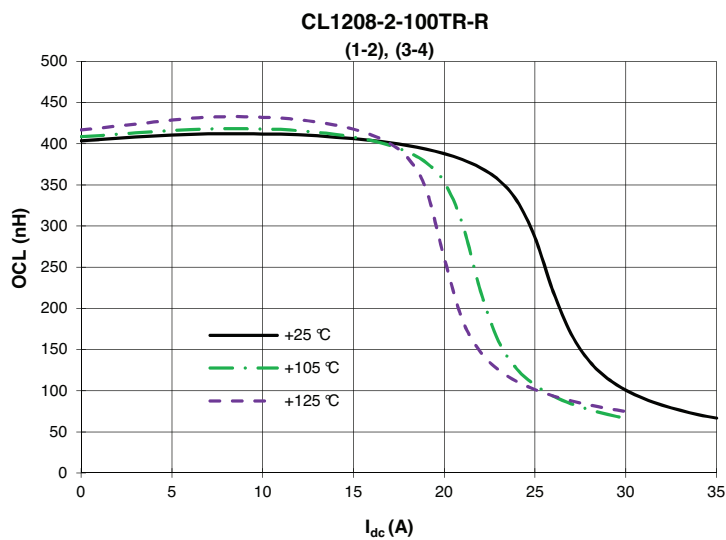

Inductance characteristics – OCL vs. current

CL1208-3-100TR-R
(3-4)

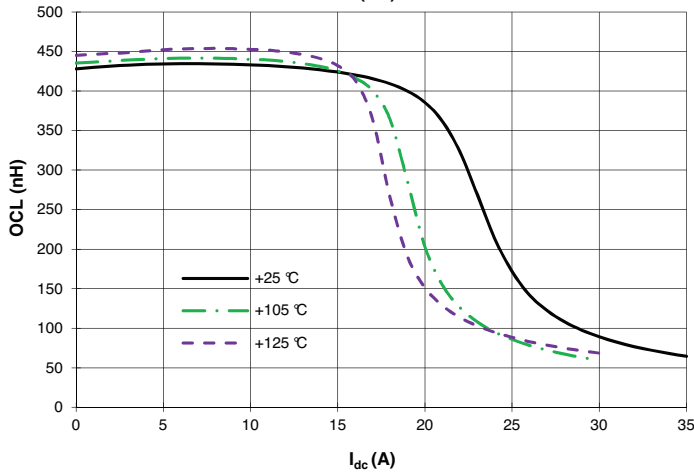

CL1208-4-100TR-R
(1-2), (7-8)

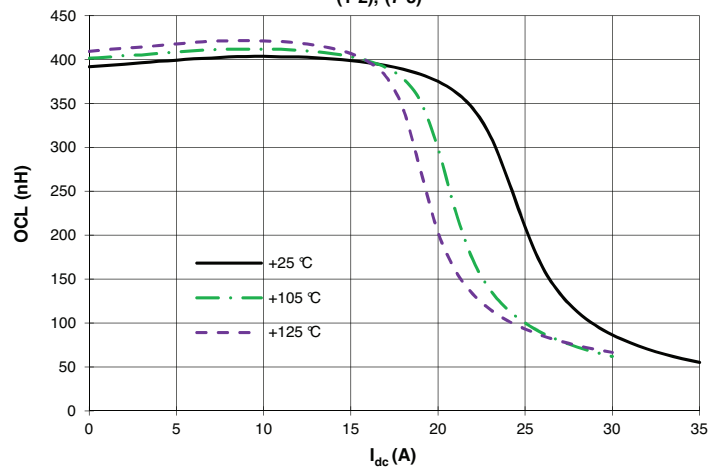

CL1208-4-100TR-R
(3-4), (5-6)

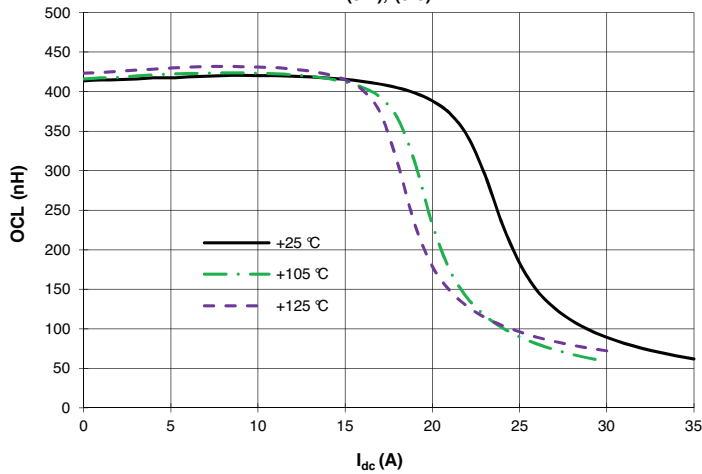

CL1208-6-100TR-R
(1-2), (11-12)

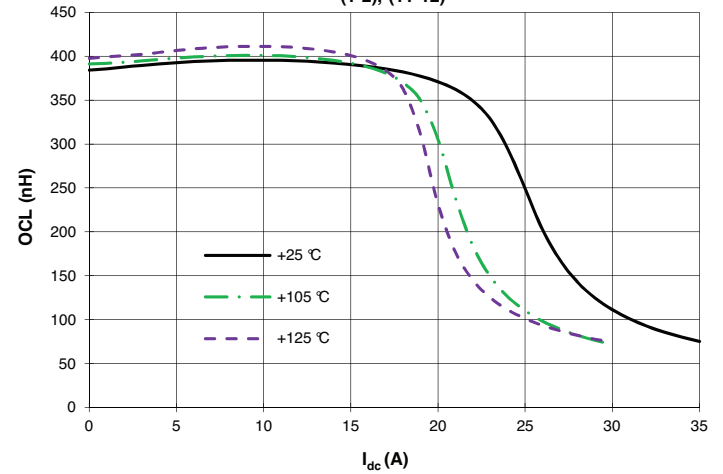

CL1208-6-100TR-R
(3-4), (9-10)

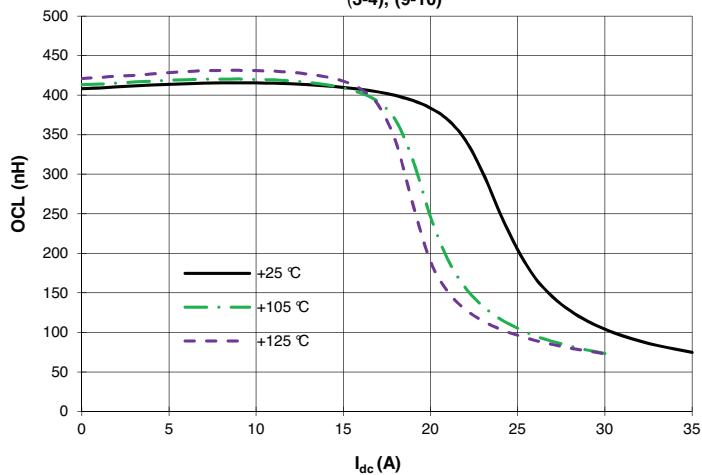

CL1208-6-100TR-R
(5-6), (7-8)

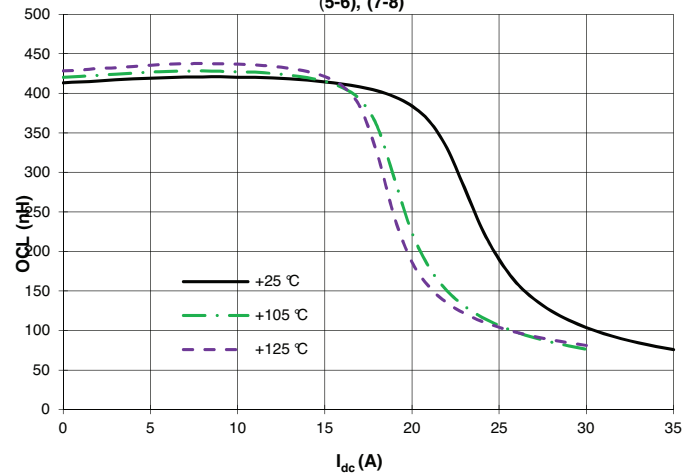

Solder reflow profile

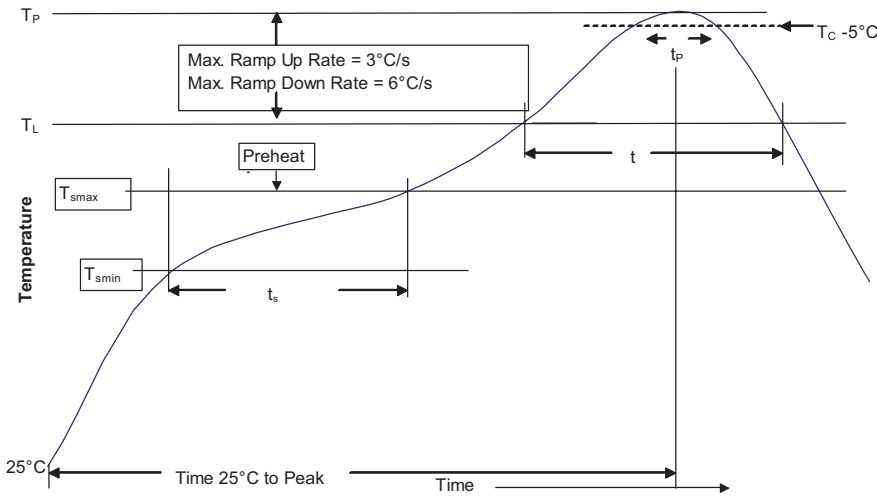

Table 1 - Standard SnPb Solder (T_c)

Package Thickness	Volume mm ³ <350	Volume mm ³ ≥350
<2.5 mm	235 °C	220 °C
≥2.5 mm	220 °C	220 °C

Table 2 - Lead (Pb) Free Solder (T_c)

Package Thickness	Volume mm ³ <350	Volume mm ³ 350 - 2000	Volume mm ³ >2000
<1.6 mm	260 °C	260 °C	260 °C
1.6 – 2.5 mm	260 °C	250 °C	245 °C
>2.5 mm	250 °C	245 °C	245 °C

Reference JDEC J-STD-020

Profile Feature	Standard SnPb Solder	Lead (Pb) Free Solder
Preheat and Soak		
• Temperature min. (T_{smin})	100 °C	150 °C
• Temperature max. (T_{smax})	150 °C	200 °C
• Time (T_{smin} to T_{smax}) (t_s)	60-120 Seconds	60-120 Seconds
Average ramp up rate T_{smax} to T_p	3°C/ Second Max.	3 °C/ Second Max.
Liquidous temperature (T_L)	183 °C	217 °C
Time at liquidous (t_L)	60-150 Seconds	60-150 Seconds
Peak package body temperature (T_p)*	Table 1	Table 2
Time (t_p)** within 5 °C of the specified classification temperature (T_c)	20 Seconds**	30 Seconds**
Average ramp-down rate (T_p to T_{smax})	6 °C/ Second Max.	6 °C/ Second Max.
Time 25 °C to Peak Temperature	6 Minutes Max.	8 Minutes Max.

* Tolerance for peak profile temperature (T_p) is defined as a supplier minimum and a user maximum.

** Tolerance for time at peak profile temperature (t_p) is defined as a supplier minimum and a user maximum.

Life Support Policy: Eaton does not authorize the use of any of its products for use in life support devices or systems without the express written approval of an officer of the Company. Life support systems are devices which support or sustain life, and whose failure to perform, when properly used in accordance with instructions for use provided in the labeling, can be reasonably expected to result in significant injury to the user.

Eaton reserves the right, without notice, to change design or construction of any products and to discontinue or limit distribution of any products. Eaton also reserves the right to change or update, without notice, any technical information contained in this bulletin.

Eaton
Electronics Division
1000 Eaton Boulevard
Cleveland, OH 44122
United States
www.eaton.com/electronics

© 2019 Eaton
All Rights Reserved
Printed in USA
Publication No. 10579 PCN19001
January 2019

Eaton is a registered trademark.
All other trademarks are property of their respective owners.

Follow us on social media to get the latest product and support information.



Mouser Electronics

Authorized Distributor

Click to View Pricing, Inventory, Delivery & Lifecycle Information:

Eaton:

[CL1208-2-100TR-R](#) [CL1208-3-100TR-R](#)