

IRF7303PbF

HEXFET® Power MOSFET

- Generation V Technology
- Ultra Low On-Resistance
- Dual N-Channel Mosfet
- Surface Mount
- Available in Tape & Reel
- Dynamic dv/dt Rating
- Fast Switching
- Lead-Free

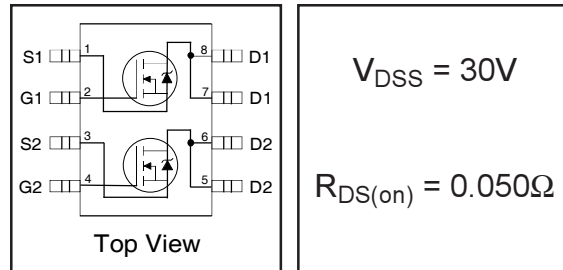

Description

Fifth Generation HEXFETs from International Rectifier utilize advanced processing techniques to achieve the lowest possible on-resistance per silicon area. This benefit, combined with the fast switching speed and ruggedized device design that HEXFET Power MOSFETs are well known for, provides the designer with an extremely efficient device for use in a wide variety of applications.

The SO-8 has been modified through a customized leadframe for enhanced thermal characteristics and multiple-die capability making it ideal in a variety of power applications. With these improvements, multiple devices can be used in an application with dramatically reduced board space. The package is designed for vapor phase, infra red, or wave soldering techniques. Power dissipation of greater than 0.8W is possible in a typical PCB mount application.

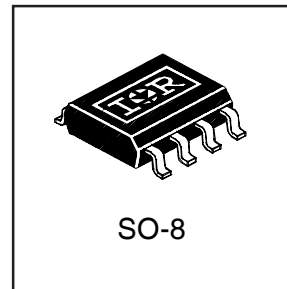

Absolute Maximum Ratings

	Parameter	Max.	Units
$I_D @ T_A = 25^\circ C$	10 Sec. Pulsed Drain Current, $V_{GS} @ 10V$	5.3	A
$I_D @ T_A = 25^\circ C$	Continuous Drain Current, $V_{GS} @ 10V$	4.9	
$I_D @ T_A = 70^\circ C$	Continuous Drain Current, $V_{GS} @ 10V$	3.9	
I_{DM}	Pulsed Drain Current $\text{\textcircled{D}}$	20	
$P_D @ T_A = 25^\circ C$	Power Dissipation	2.0	W
	Linear Derating Factor	0.016	W/°C
V_{GS}	Gate-to-Source Voltage	± 20	V
dv/dt	Peak Diode Recovery dv/dt $\text{\textcircled{D}}$	5.0	V/ns
T_J, T_{STG}	Junction and Storage Temperature Range	-55 to + 150	°C

Thermal Resistance Ratings

	Parameter	Typ.	Max.	Units
$R_{\theta JA}$	Maximum Junction-to-Ambient $\text{\textcircled{D}}$	---	62.5	°C/W

IRF7303PbF

International
IR Rectifier

Electrical Characteristics @ $T_J = 25^\circ\text{C}$ (unless otherwise specified)

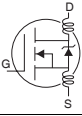
	Parameter	Min.	Typ.	Max.	Units	Conditions
$V_{(BR)DSS}$	Drain-to-Source Breakdown Voltage	30	—	—	V	$V_{GS} = 0V, I_D = 250\mu A$
$\Delta V_{(BR)DSS}/\Delta T$	Breakdown Voltage Temp. Coefficient	—	0.032	—	V/°C	Reference to $25^\circ\text{C}, I_D = 1\text{mA}$
$R_{DS(ON)}$	Static Drain-to-Source On-Resistance	—	—	0.050	Ω	$V_{GS} = 10V, I_D = 2.4A$ ③
		—	—	0.080		$V_{GS} = 4.5V, I_D = 2.0A$ ③
$V_{GS(th)}$	Gate Threshold Voltage	1.0	—	—	V	$V_{DS} = V_{GS}, I_D = 250\mu A$
g_{fs}	Forward Transconductance	5.2	—	—	S	$V_{DS} = 15V, I_D = 2.4A$
I_{DSS}	Drain-to-Source Leakage Current	—	—	1.0	μA	$V_{DS} = 24V, V_{GS} = 0V$
		—	—	25		$V_{DS} = 24V, V_{GS} = 0V, T_J = 125^\circ\text{C}$
I_{GSS}	Gate-to-Source Forward Leakage	—	—	100	nA	$V_{GS} = 20V$
	Gate-to-Source Reverse Leakage	—	—	-100		$V_{GS} = -20V$
Q_g	Total Gate Charge	—	—	25	nC	$I_D = 2.4A$
Q_{gs}	Gate-to-Source Charge	—	—	2.9		$V_{DS} = 24V$
Q_{gd}	Gate-to-Drain ("Miller") Charge	—	—	7.9		$V_{GS} = 10V$, See Fig. 6 and 12 ③
$t_{d(on)}$	Turn-On Delay Time	—	6.8	—	ns	$V_{DD} = 15V$ $I_D = 2.4A$ $R_G = 6.0\Omega$ $R_D = 6.2\Omega$, See Fig. 10 ③
t_r	Rise Time	—	21	—		
$t_{d(off)}$	Turn-Off Delay Time	—	22	—		
t_f	Fall Time	—	7.7	—		
L_D	Internal Drain Inductance	—	4.0	—	nH	Between lead tip and center of die contact 
L_S	Internal Source Inductance	—	6.0	—		
C_{iss}	Input Capacitance	—	520	—	pF	$V_{GS} = 0V$ $V_{DS} = 25V$ $f = 1.0\text{MHz}$, See Fig. 5
C_{oss}	Output Capacitance	—	180	—		
C_{rss}	Reverse Transfer Capacitance	—	72	—		

Source-Drain Ratings and Characteristics

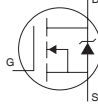
	Parameter	Min.	Typ.	Max.	Units	Conditions
I_S	Continuous Source Current (Body Diode)	—	—	2.5	A	MOSFET symbol showing the integral reverse p-n junction diode. 
I_{SM}	Pulsed Source Current (Body Diode) ①	—	—	20		
V_{SD}	Diode Forward Voltage	—	—	1.0	V	$T_J = 25^\circ\text{C}, I_S = 1.8A, V_{GS} = 0V$ ③
t_{rr}	Reverse Recovery Time	—	47	71	ns	$T_J = 25^\circ\text{C}, I_F = 2.4A$
Q_{rr}	Reverse Recovery Charge	—	56	84	nC	$di/dt = 100A/\mu s$ ③
t_{on}	Forward Turn-On Time	Intrinsic turn-on time is negligible (turn-on is dominated by $L_S + L_D$)				

Notes:

① Repetitive rating; pulse width limited by max. junction temperature. (See fig. 11)

③ Pulse width $\leq 300\mu s$; duty cycle $\leq 2\%$.

② $I_{SD} \leq 2.4A, di/dt \leq 73A/\mu s, V_{DD} \leq V_{(BR)DSS}, T_J \leq 150^\circ\text{C}$

④ Surface mounted on FR-4 board, $t \leq 10\text{sec}$.

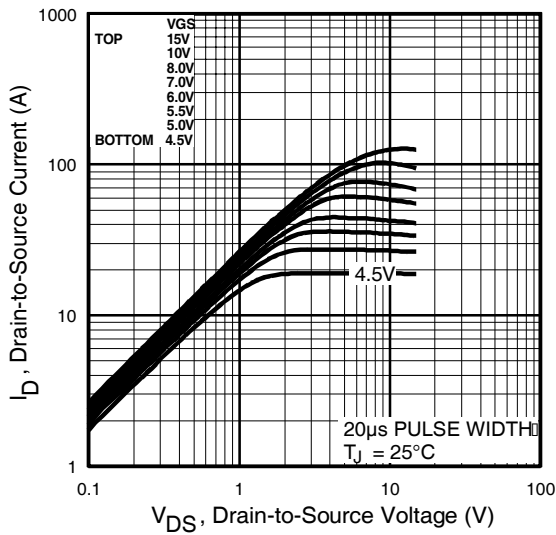

Fig 1. Typical Output Characteristics

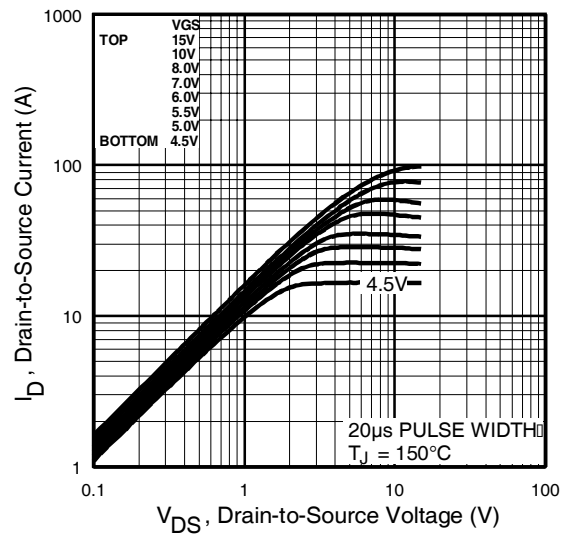

Fig 2. Typical Output Characteristics

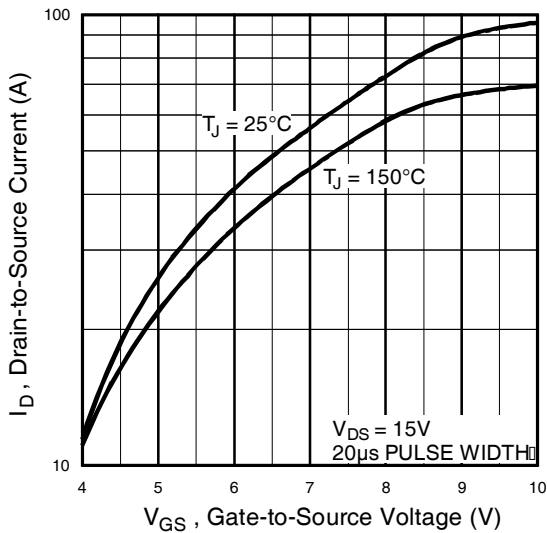

Fig 3. Typical Transfer Characteristics

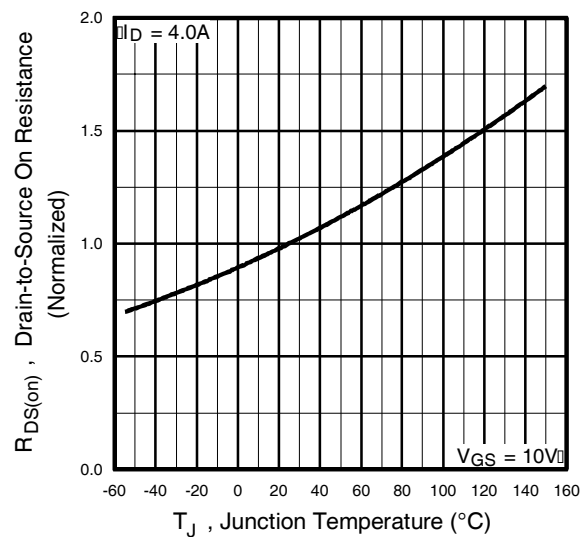

Fig 4. Normalized On-Resistance Vs. Temperature

IRF7303PbF

International
IR Rectifier

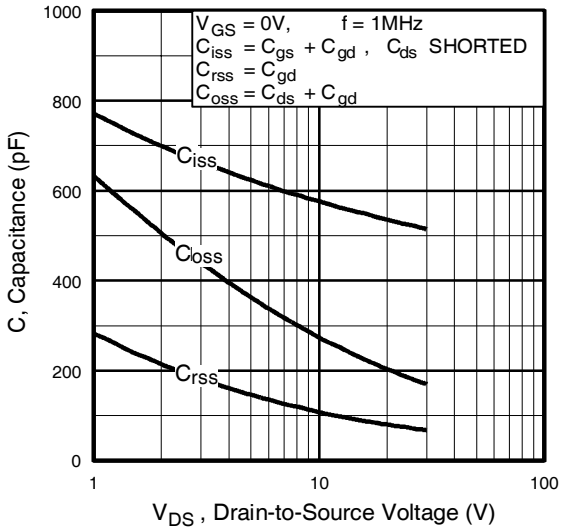

Fig 5. Typical Capacitance Vs. Drain-to-Source Voltage

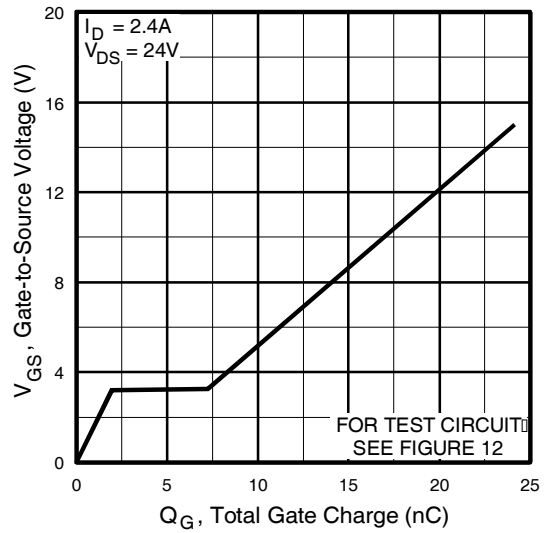

Fig 6. Typical Gate Charge Vs. Gate-to-Source Voltage

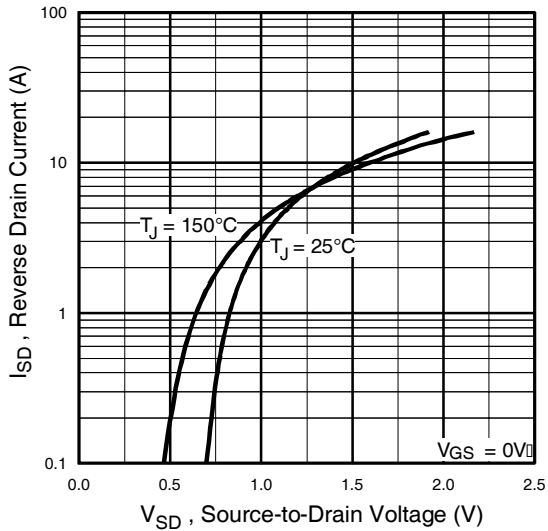

Fig 7. Typical Source-Drain Diode Forward Voltage

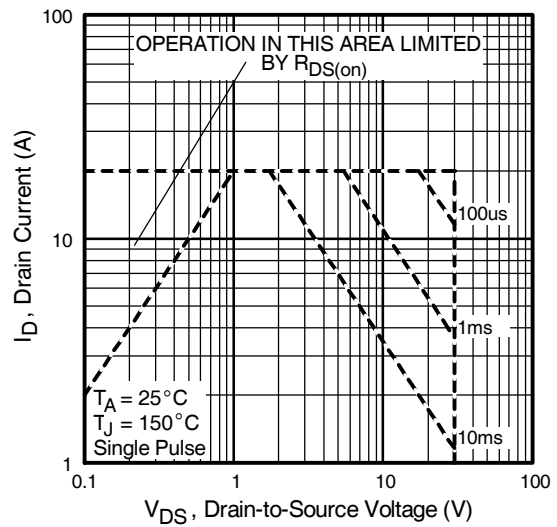

Fig 8. Maximum Safe Operating Area

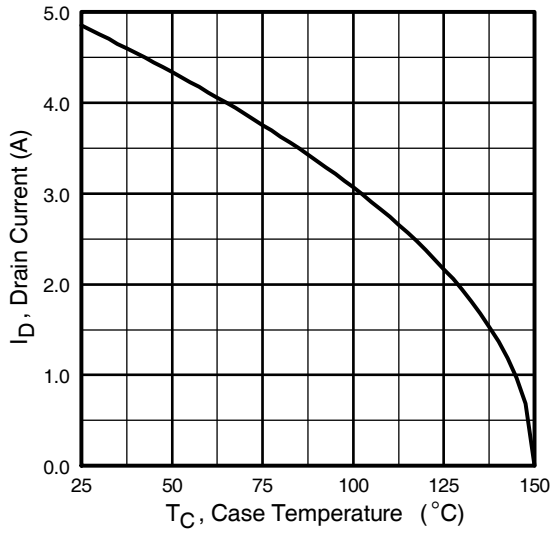

Fig 9. Maximum Drain Current Vs. Ambient Temperature

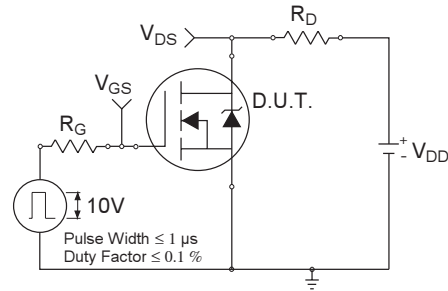

Fig 10a. Switching Time Test Circuit

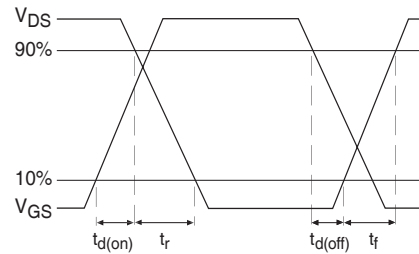

Fig 10b. Switching Time Waveforms

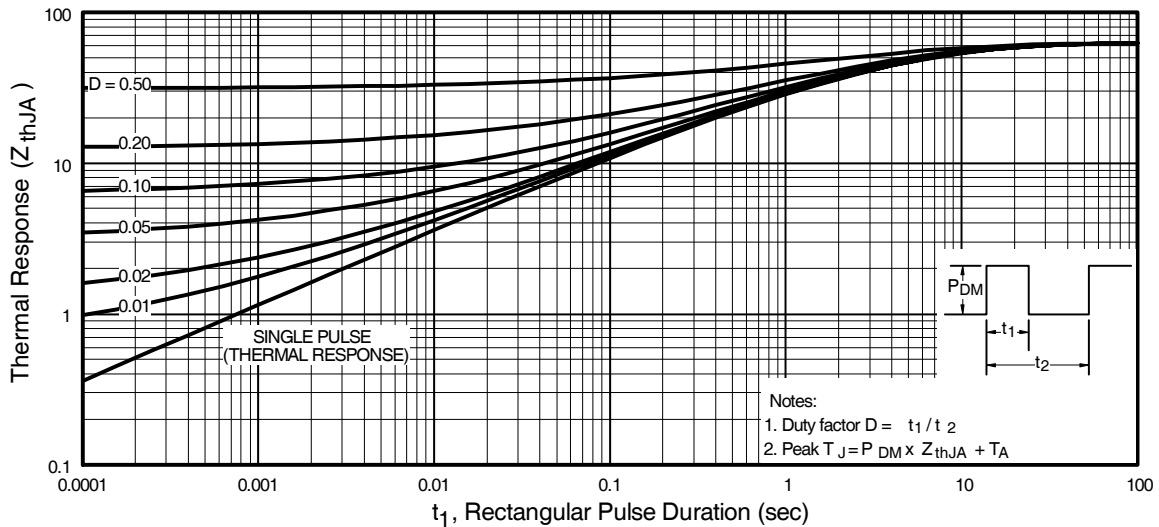

Fig 11. Maximum Effective Transient Thermal Impedance, Junction-to-Ambient

IRF7303PbF

International
IR Rectifier

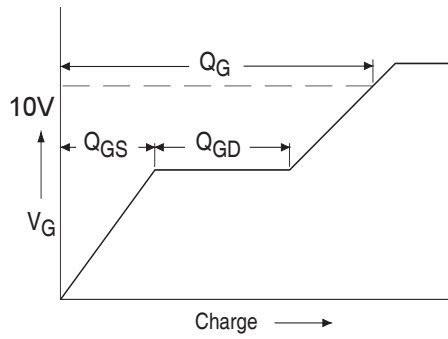

Fig 12a. Basic Gate Charge Waveform

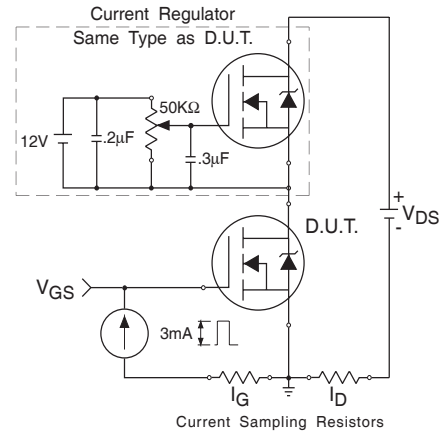

Fig 12b. Gate Charge Test Circuit

Peak Diode Recovery dv/dt Test Circuit

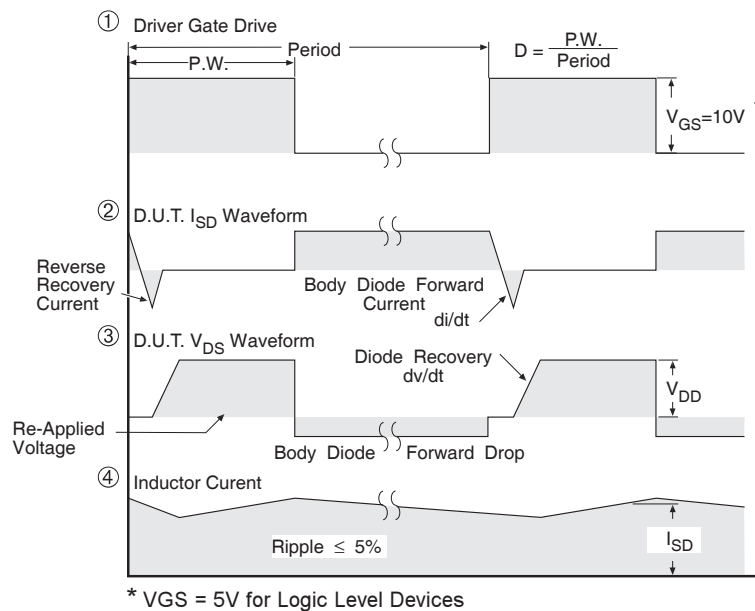
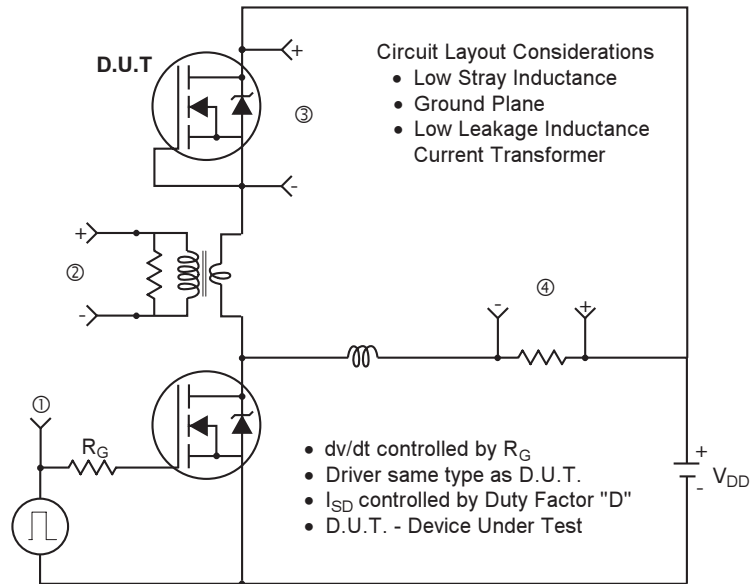

Fig 13. For N-Channel HEXFETS

IRF7303PbF

International
IR Rectifier

SO-8 Package Outline

Dimensions are shown in millimeters (inches)

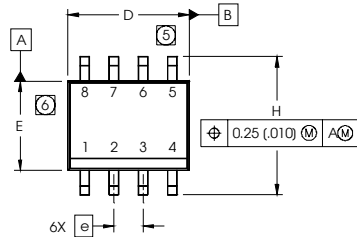

DIM	INCHES		MILLIMETERS	
	MIN	MAX	MIN	MAX
A	.0532	.0688	1.35	1.75
AI	.0040	.0098	0.10	0.25
b	.013	.020	0.33	0.51
c	.0075	.0098	0.19	0.25
D	.189	.1968	4.80	5.00
E	.1497	.1574	3.80	4.00
e	.050 BASIC		1.27 BASIC	
e1	.025 BASIC		0.635 BASIC	
H	.2284	.2440	5.80	6.20
K	.0099	.0196	0.25	0.50
L	.016	.050	0.40	1.27
y	0°	8°	0°	8°

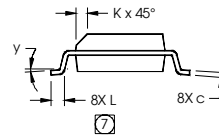
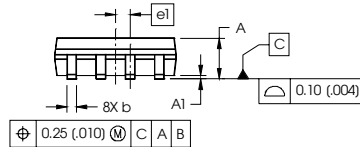

NOTES:

1. DIMENSIONING & TOLERANCING PER ASME Y14.5M-1994.
2. CONTROLLING DIMENSION: MILLIMETER
3. DIMENSIONS ARE SHOWN IN MILLIMETERS (INCHES).
4. OUTLINE CONFORMS TO JEDEC OUTLINE MS-012AA.
5. DIMENSION DOES NOT INCLUDE MOLD PROTRUSIONS. MOLD PROTRUSIONS NOT TO EXCEED 0.15 (.006).
6. DIMENSION DOES NOT INCLUDE MOLD PROTRUSIONS. MOLD PROTRUSIONS NOT TO EXCEED 0.25 (.010).
7. DIMENSION IS THE LENGTH OF LEAD FOR SOLDERING TO A SUBSTRATE.

FOOTPRINT

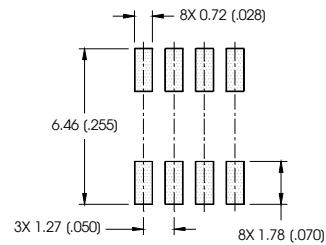

SO-8 Part Marking Information (Lead-Free)

EXAMPLE: THIS IS AN IRF7101 (MOSFET)

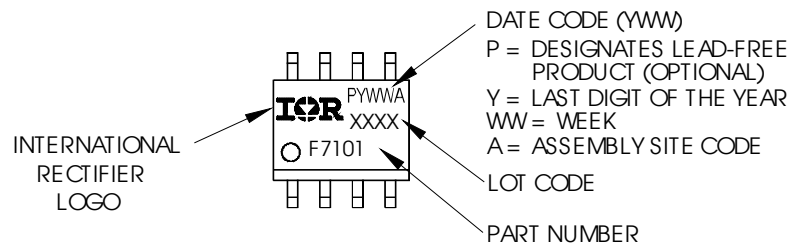

SO-8 Tape and Reel

Dimensions are shown in millimeters (inches)

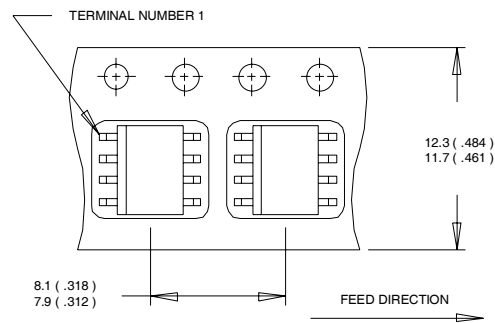

NOTES:

1. CONTROLLING DIMENSION : MILLIMETER.
2. ALL DIMENSIONS ARE SHOWN IN MILLIMETERS(INCHES).
3. OUTLINE CONFORMS TO EIA-481 & EIA-541.

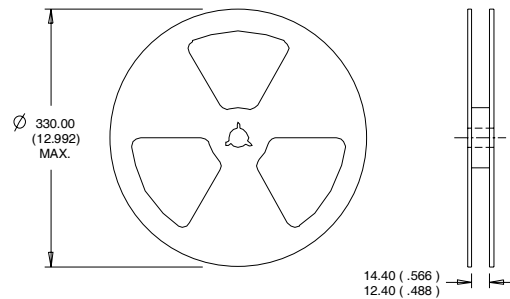

NOTES :

1. CONTROLLING DIMENSION : MILLIMETER.
2. OUTLINE CONFORMS TO EIA-481 & EIA-541.

Data and specifications subject to change without notice.
 This product has been designed and qualified for the Consumer market.
 Qualifications Standards can be found on IR's Web site.

International
IR Rectifier

IR WORLD HEADQUARTERS: 233 Kansas St., El Segundo, California 90245, USA Tel: (310) 252-7105
 TAC Fax: (310) 252-7903

Visit us at www.irf.com for sales contact information.10/04

IMPORTANT NOTICE

The information given in this document shall in no event be regarded as a guarantee of conditions or characteristics ("Beschaffheitsgarantie").

With respect to any examples, hints or any typical values stated herein and/or any information regarding the application of the product, Infineon Technologies hereby disclaims any and all warranties and liabilities of any kind, including without limitation warranties of non-infringement of intellectual property rights of any third party.

In addition, any information given in this document is subject to customer's compliance with its obligations stated in this document and any applicable legal requirements, norms and standards concerning customer's products and any use of the product of Infineon Technologies in customer's applications.

The data contained in this document is exclusively intended for technically trained staff. It is the responsibility of customer's technical departments to evaluate the suitability of the product for the intended application and the completeness of the product information given in this document with respect to such application.

For further information on the product, technology, delivery terms and conditions and prices please contact your nearest Infineon Technologies office (www.infineon.com).

WARNINGS

Due to technical requirements products may contain dangerous substances. For information on the types in question please contact your nearest Infineon Technologies office.

Except as otherwise explicitly approved by Infineon Technologies in a written document signed by authorized representatives of Infineon Technologies, Infineon Technologies' products may not be used in any applications where a failure of the product or any consequences of the use thereof can reasonably be expected to result in personal injury.