

DATA SHEET

HIGH CURRENT ZERO OHM JUMPER

PA series

sizes 0100/ 0201/ 0402/ 0603/ 0805/ 1206/ 2010/ 2512

RoHS compliant & Halogen free



SCOPE

This specification describes PA0100~2512 series jumper with metal alloy layer.

APPLICATIONS

- Consumer goods
- Computer
- Telecom / Datacom
- Industrial / Power supply
- Alternative Energy
- Car electronics

FEATURES

- PA Jumper resistors are designed to be used as a zero ohm jumper
- AEC-Q200 qualified
- Halogen-free Epoxy
- RoHS compliant
- Reduce environmentally hazardous wastes
- High component and equipment reliability
- Non-forbidden materials used in products/production
- High current capability
- Moisture sensitivity level: MSL 1

ORDERING INFORMATION - GLOBAL PART NUMBER

Global part numbers are identified by the series, size, tolerance, packing type, temperature coefficient, taping reel and resistance value.

GLOBAL PART NUMBER

PA XXXX X X X XX OR L
(1) (2) (3) (4) (5) (6) (7)

(1) SIZE

0100 / 0201 / 0402 / 0603 / 0805 / 1206 / 2010 / 2512

(2) TOLERANCE

-

(3) PACKAGING TYPE

R = Paper taping reel (PA0100~1206)
 K = Embossed taping reel (PA2010~2512)

(4) TEMPERATURE COEFFICIENT OF RESISTANCE

-

(5) TAPING REEL

07 = 7 inch dia. Reel
 7W = 7 inch dia. Reel, (0402 only)
 47 = 7 inch dia. Reel, (0805 only)

(6) RESISTANCE VALUE

OR = 0 Ω

(7) DEFAULT CODE

Letter L is the system default code for ordering only. (Note)

Resistance rule of global part number

Resistance code rule	Example
OR (0 Ω)	OR = 0 Ω

ORDERING EXAMPLE

The ordering code for a PA0603 chip resistor, value 0 Ω, supplied in 7-inch tape reel with 5Kpcs quantify is: PA0603-R-070RL.

NOTE

1. All our RChip products are RoHS compliant. "LFP" of the internal 2D reel label mentions "Lead-Free Process"

MARKING

PA0201

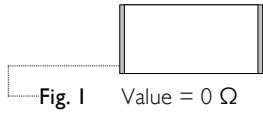

No Marking

PA0100 / 0402 / 0603 / 0805 / 1206 / 2010 / 2512

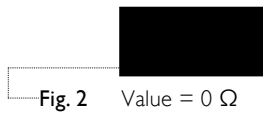

No Marking

CONSTRUCTION

The advanced resistive material is adopted to get the low resistance and is covered with a protective coat. Finally, the three external terminations (Cu / Ni / matte Tin) are added, as shown in Fig. 3.

Outlines

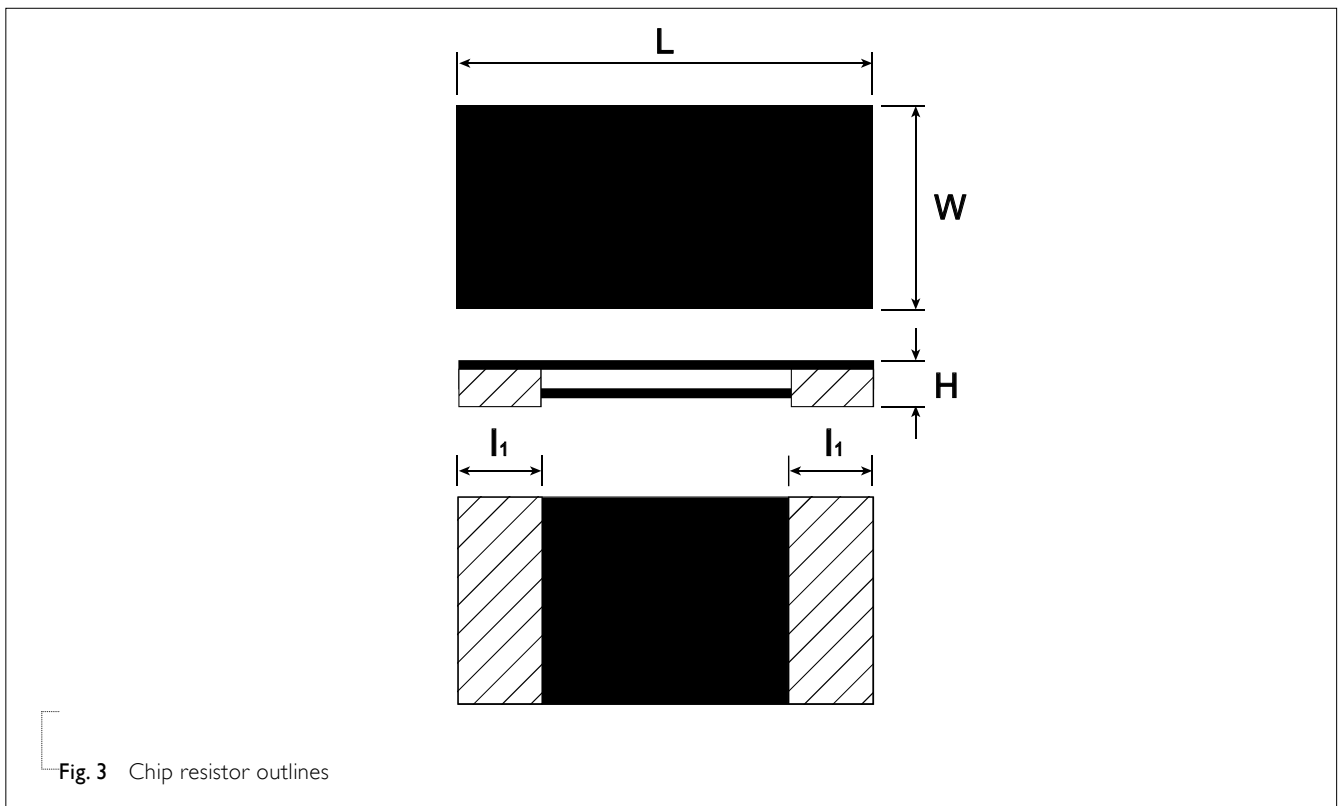

DIMENSION

Table 1 For outlines, please refer to Fig. 3

TYPE	L (mm)	W (mm)	H (mm)	l ₁ (mm)
PA0100	0.40±0.03	0.20±0.03	Max. 0.15	0.10±0.03
PA0201	0.60±0.03	0.31±0.04	Max. 0.35	0.15±0.06
PA0402	1.00±0.10	0.55±0.10	Max. 0.35	0.25±0.10
PA0603	1.60±0.20	0.8+0.10/-0.20	0.45±0.15	0.38±0.12
PA0805	2.00±0.15	1.20±0.15	Max. 0.40	0.35±0.25
PA1206	3.05±0.20	1.52±0.20	0.50±0.20	0.70±0.20
PA2010	5.08±0.20	2.54±0.20	0.40±0.15	0.70±0.20
PA2512	6.35±0.20	3.05±0.15	0.45±0.15	1.40±0.20

Note:

1. For relevant physical dimensions, please refer to construction outlines.
2. Please contact with sales offices, distributors and representatives in your region before ordering.

ELECTRICAL CHARACTERISTICS

Table 2

	PA0100	PA0201	PA0402	PA0603	PA0805	PA1206	PA2010	PA2512
Global part number (code 09-10)	07	07	07	7W	07	47	07	07
Resistance Value, Max. (mΩ)	≤2mΩ	≤5mΩ	≤1mΩ	≤0.2mΩ	≤0.2mΩ	≤0.2mΩ	≤0.2mΩ	≤0.2mΩ
Jumper Criteria								
Rated Current (A)	8	4.5	11	23	50	50	70.7	100
Rated Power (W)	1/8	1/10	1/8	1/10	1/2	1/2	1	2
Operating Temperature Range	-55°C to +125°C			-55°C to +155°C		-55°C to +170°C		

Note: Please contact with sales offices, distributors and representatives in your region before ordering.

FUNCTIONAL DESCRIPTION

OPERATING TEMPERATURE RANGE

PA0100 to PA0402: -55°C to +125°C
 PA0603/ PA0805: -55°C to +155°C
 PA1206/PA2010/PA2512: -55°C to +170°C

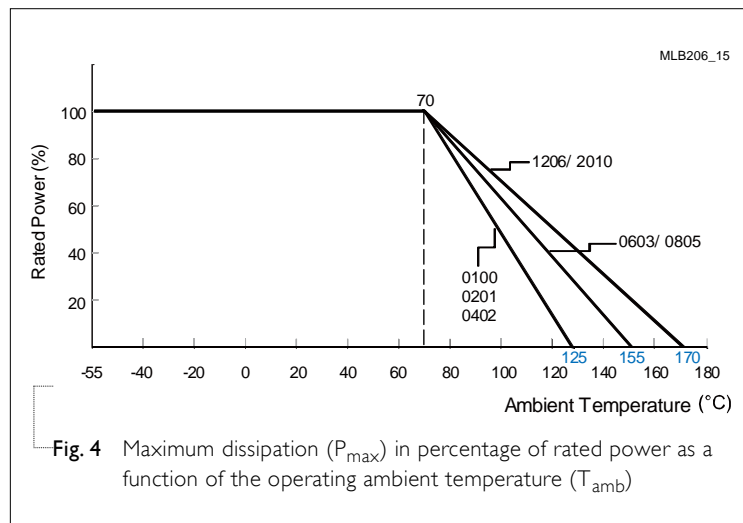

Fig. 4 Maximum dissipation (P_{max}) in percentage of rated power as a function of the operating ambient temperature (T_{amb})

PACKING STYLE AND PACKAGING QUANTITY

Table 3 Packing style and packaging quantity

PACKING STYLE	REEL DIMENSION	PA0100	PA0201	PA0402	PA0603	PA0805	PA1206	PA2010	PA2512
Paper taping reel (R)	7" (178 mm)	20,000	10,000	10,000	5,000	5,000	4000	---	---
Embossed Taping Reel (K)	7" (178 mm)	---	---	---	---	---	---	4000	4000

PAPER TAPE

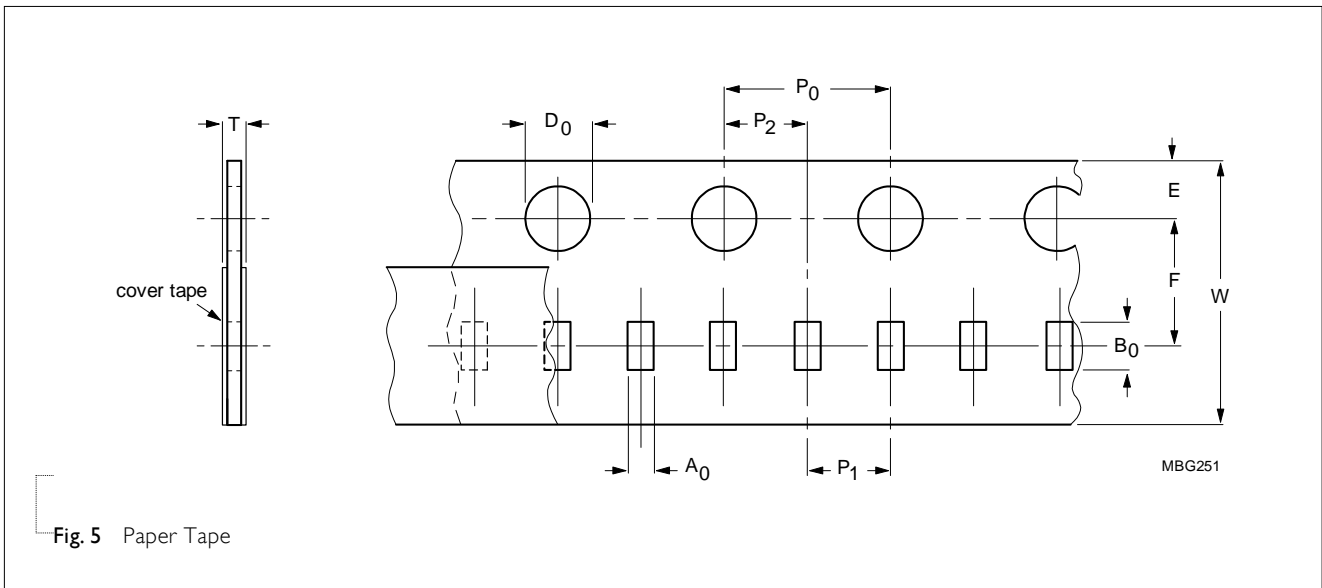

Fig. 5 Paper Tape

Table 4 Dimensions of paper tape for relevant chip resistors size

SIZE	SYMBOL										Unit: mm
	A ₀	B ₀	W	E	F	P ₀	P ₁	P ₂	ØD ₀	T	
PA0100	0.24±0.03	0.45±0.03	8.00±0.20	1.75±0.10	3.50±0.05	4.00±0.05	2.00±0.10	2.00±0.05	1.50±0.10	0.31±0.10	
PA0201	0.38±0.10	0.68±0.10	8.00±0.10	1.75±0.10	3.50±0.10	4.00±0.10	2.00±0.10	2.00±0.10	1.55±0.05	0.42±0.10	
PA0402	0.59±0.10	1.20±0.10	8.00±0.10	1.75±0.10	3.50±0.10	4.00±0.10	2.00±0.10	2.00±0.10	1.55±0.05	0.45±0.10	
PA0603	1.10±0.10	1.90±0.10	8.00±0.10	1.75±0.10	3.50±0.10	4.00±0.10	4.00±0.10	2.00±0.10	1.55±0.05	0.43±0.10	
PA0805	1.62±0.10	2.35±0.10	8.00±0.10	1.75±0.10	3.50±0.10	4.00±0.10	4.00±0.10	2.00±0.10	1.55±0.05	0.43±0.10	
PA1206	1.90±0.20	3.50±0.20	8.00±0.20	1.75±0.10	3.50±0.50	4.00±0.10	4.00±0.10	2.00±0.05	1.50±0.10	0.75+0.20/-0	

EMBOSSED TAPE

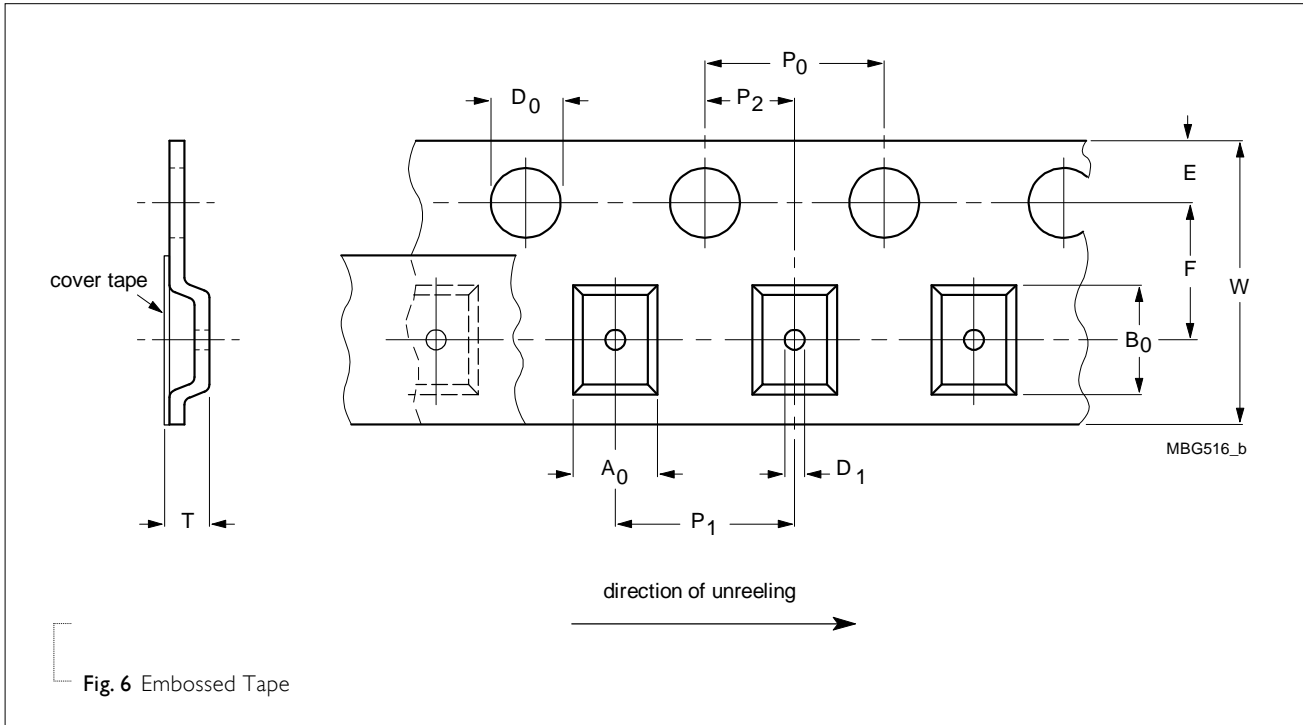

Fig. 6 Embossed Tape

Table 5 Dimensions of embossed tape for relevant chip resistors size

SIZE	SYMBOL										Unit: mm
	A ₀	B ₀	W	E	F	P ₀	P ₁	P ₂	ΦD ₀	ΦD ₁	
PA2010	2.80±0.15	5.40±0.15	12.0±0.30	1.75±0.10	5.50±0.10	4.00±0.10	4.00±0.10	2.00±0.10	1.50±0.10	1.50±0.10	0.80±0.15
PA2512	3.40±0.15	6.70±0.15	12.0±0.30	1.75±0.10	5.50±0.10	4.00±0.10	4.00±0.10	2.00±0.10	1.50±0.10	1.50±0.10	0.80±0.15

REEL SPECIFICATION

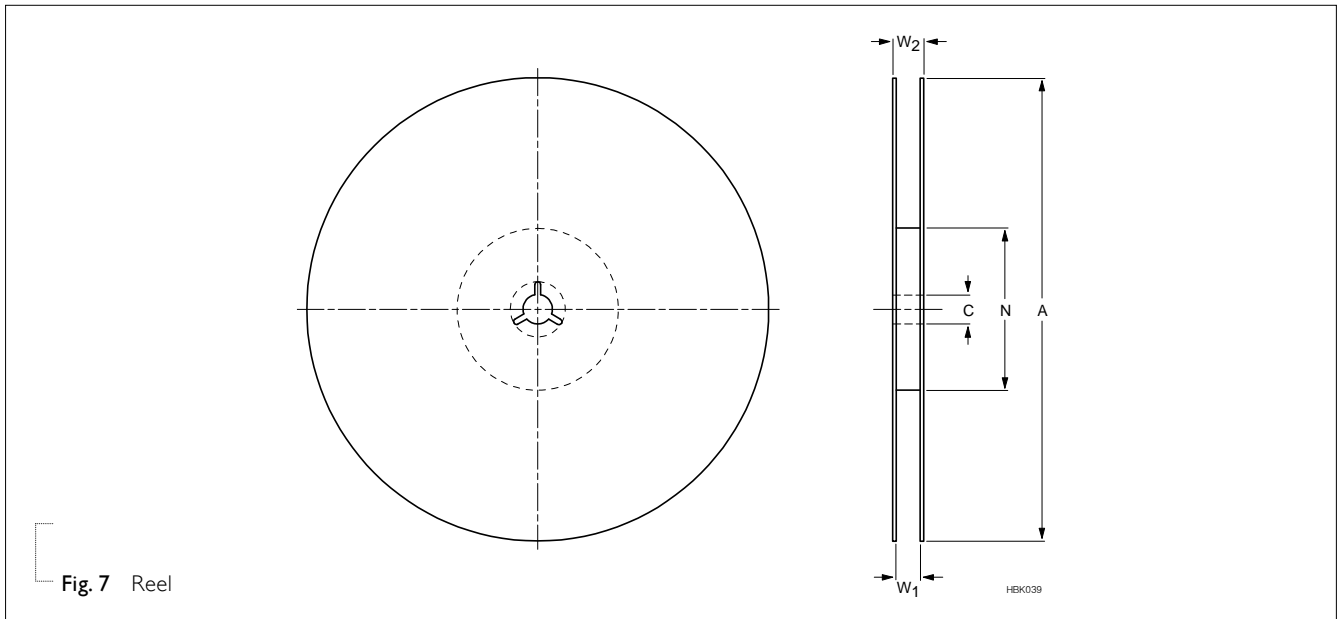

Fig. 7 Reel

Table 6 Dimensions of reel specification for relevant chip resistors size

SIZE	QUANTITY PER REEL	REEL SIZE		SYMBOL	Unit: mm				
		8 mm TAPE WIDE	12 mm TAPE WIDE		A	N	C	D	W ₁
PA0100	20,000	7" (Ø 178 mm)	---	180.0+0/-3.0	60.0+1/-0	13.0± 0.2	21.0± 0.8	9.0± 0.3	11.4± 1.0
PA0201	10,000	7" (Ø 178 mm)	---	178.0± 1.0	60.0+1/-0	13.5± 0.5	21.0± 0.8	9.0± 0.5	12.0± 0.2
PA0402	10,000	7" (Ø 178 mm)	---	178.0± 1.0	60.0+1/-0	13.5± 0.5	21.0± 0.8	9.0± 0.5	12.0± 0.2
PA0603	5,000	7" (Ø 178 mm)	---	178.0± 1.0	60.0+1/-0	13.5± 0.5	21.0± 0.8	9.0± 0.5	12.0± 0.2
PA0805	5,000	7" (Ø 178 mm)	---	178.0± 1.0	60.0+1/-0	13.5± 0.5	21.0± 0.8	9.0± 0.5	12.0± 0.2
PA1206	4,000	7" (Ø 178 mm)	---	178.0± 1.0	60.0+1/-0	13.5± 0.5	21.0± 0.8	9.0± 0.5	12.0± 0.2
PA2010	4,000	---	7" (Ø 178 mm)	178.0± 1.0	60.0+1/-0	13.5± 0.5	21.0± 0.8	13.6± 0.5	16.5± 0.5
PA2512	4,000	---	7" (Ø 178 mm)	178.0± 1.0	60.0+1/-0	13.5± 0.5	21.0± 0.8	13.6± 0.5	16.5± 0.5

LEADER/TRAILER TAPE SPECIFICATION

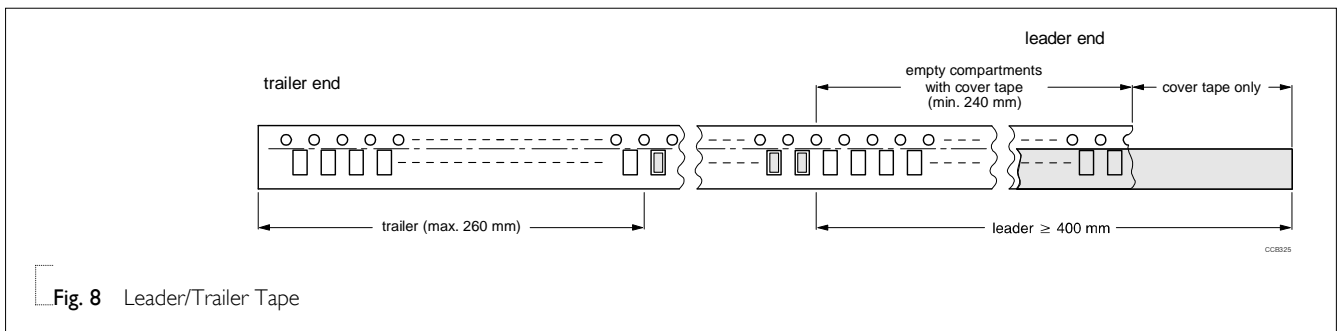

Fig. 8 Leader/Trailer Tape

FOOTPRINT AND SOLDERING PROFILES

For recommended soldering profiles, please refer to data sheet “Chip resistors mounting”.

FOOTPRINT

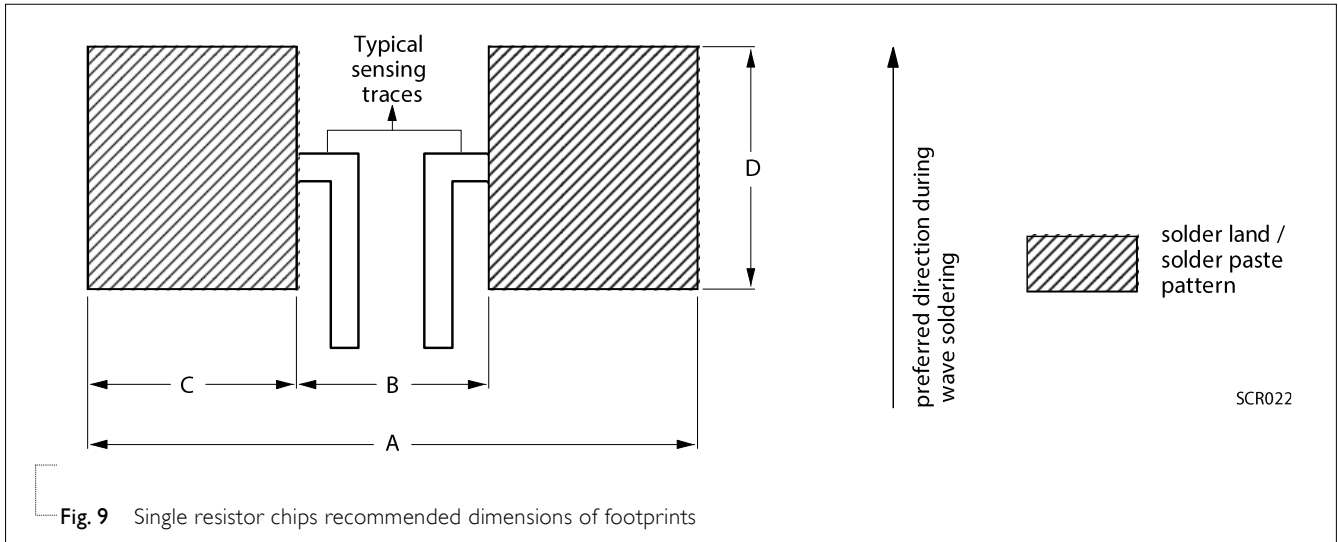

Table 7 Footprint dimensions

SIZE	A	B	C	D	Unit: mm
PA0100	0.5~0.8	0.16~0.2	0.17~0.3	0.2~0.4	
PA0201	1.0	0.3	0.35	0.4	
PA0402	2.0	0.4	0.8	0.6	
PA0603	2.2	0.8	0.7	0.9	
PA0805	3.4	0.8	1.3	1.3	
PA1206	4.0	1.0	1.5	1.8	
PA2010	6.0	3.5	1.25	3.0	
PA2512	6.75	3.15	1.8	3.45	

TESTS AND REQUIREMENTS

Table 8 Test condition, procedure and requirements

TEST	TEST METHOD	PROCEDURE	REQUIREMENT
Life/ Endurance	MIL-STD-202 Method 108	1,000 hours at 70±2°C applied rated current	0100 : < 2mΩ
	IEC 60115-1 7.1	1.5 hours on, 0.5 hour off, still air required	0201: < 5mΩ 0402: < 1mΩ (07) < 0.2mΩ (7W) Others : < 0.2mΩ
High Temperature Exposure/ Endurance at upper category temperature	MIL-STD-202 Method 108	1,000 hours, unpowered at	0100 : < 2mΩ
	IEC 60068-2-2	0100/ 0201/ 0402 : 125±5°C 0603/ 0805 : 155±5°C 1206/2010/2512 : 170±5°C	0201: < 5mΩ 0402: < 1mΩ (07) < 0.2mΩ (7W) Others : < 0.2mΩ
Short time overload	IEC 60115-1 8.1	5 times rated power for 5 seconds.	0100 : < 2mΩ 0201: < 5mΩ 0402: < 1mΩ (07) < 0.2mΩ (7W) Others : < 0.2mΩ
Board Flex/ Bending	AEC-Q200-005	Device mounted on PCB test board as described, only 1 board bending required Bending for 0100 : 5mm 0201 : 3 mm 0402 and above: 2mm Bending time: 60+5 seconds Ohmic value checked during bending	0100 : < 2mΩ 0201: < 5mΩ 0402: < 1mΩ (07) < 0.2mΩ (7W) Others : < 0.2mΩ
Solderability	J-STD	1) Baking 4 hours @155 °C dry heat, dipping at @245±3 °C for 5±0.5 second 2) Baking 4 hours @155 °C dry heat, dipping at @260±3 °C for 30±0.5 second	Good tinning (≥95% covered); no visual damage.
- Resistance to Soldering Heat	MIL-STD-202 Method 210	Specimen passed 3 times reflow temperature at 260°C, with solder	0100 : < 2mΩ 0201: < 5mΩ 0402: < 1mΩ (07) < 0.2mΩ (7W) Others : < 0.2mΩ No visible damage

REVISION HISTORY

REVISION	DATE	CHANGE NOTIFICATION	DESCRIPTION
Version 3	Jan. 20, 2025	-	- Add sizes of PA2512
Version 2	Nov. 27, 2023	-	- Upgrade PA0805 & PA0402 specification and add the coding remark in table 2.
Version 1	Jan. 27, 2021	-	- Add sizes of PA0100, PA1206 and PA2010
Version 0	Oct. 05, 2018	-	- Metal low ohmic jumper - PA series

LEGAL DISCLAIMER

YAGEO, its distributors and agents (collectively, "YAGEO"), hereby disclaims any and all liabilities for any errors, inaccuracies or incompleteness contained in any product related information, including but not limited to product specifications, datasheets, pictures and/or graphics. YAGEO may make changes, modifications and/or improvements to product related information at any time and without notice.

YAGEO makes no representation, warranty, and/or guarantee about the fitness of its products for any particular purpose or the continuing production of any of its products. To the maximum extent permitted by law, YAGEO disclaims (i) any and all liability arising out of the application or use of any YAGEO product, (ii) any and all liability, including without limitation special, consequential or incidental damages, and (iii) any and all implied warranties, including warranties of fitness for a particular purpose, non-infringement and merchantability.

YAGEO products are designed for general purpose applications under normal operation and usage conditions. Please contact YAGEO for the applications listed below which require especially high reliability for the prevention of defects which might directly cause damage to the third party's life, body or property: Aerospace equipment (artificial satellite, rocket, etc.), Atomic energy-related equipment, Aviation equipment, Disaster prevention equipment, crime prevention equipment, Electric heating apparatus, burning equipment, Highly public information network equipment, data-processing equipment, Medical devices, Military equipment, Power generation control equipment, Safety equipment, Traffic signal equipment, Transportation equipment and Undersea equipment, or for any other application or use in which the failure of YAGEO products could result in personal injury or death, or serious property damage. Particularly **YAGEO Corporation and its affiliates do not recommend the use of commercial or automotive grade products for high reliability applications or manned space flight.**

Information provided here is intended to indicate product specifications only. YAGEO reserves all the rights for revising this content without further notification, as long as products are unchanged. Any product change will be announced by PCN.