

4

3

2

1

THIS DRAWING IS UNPUBLISHED. RELEASED FOR PUBLICATION 20  
 © COPYRIGHT 20 BY - ALL RIGHTS RESERVED.

| REVISIONS |     |  |            |     |      |
|-----------|-----|--|------------|-----|------|
| P         | LTR | DESCRIPTION                            | DATE       | DWN | APVD |
| A         |     | A REVISION RELEASE                     | 07JUNE2022 | SY  | HL   |
| B         |     | ADD NEW PN                             | 10NOV2022  | MC  | HL   |
| C         |     | UPDATE HARD TRAY IN SHEETS, NEW ADD PN | 24NOV2022  | MC  | HL   |
| D         |     | CORRECT TYPO IN 6-2364427-9            | 5DEC2022   | MC  | HL   |

Top view of the connector showing dimensions: D, B±0.23, A REF, 11.65 REF, 14.50 REF, 4.02 REF 2X, PIN B"N+12", PIN A"N+12", PIN B1, PIN A1, KEY  $\phi$ , and callout 4.

NOTES:

1 MATERIAL:  
 HOUSING: HIGH-TEMP PLASTIC, BLACK, UL 94V-0  
 CONTACT: COPPER ALLOY  
 HOLD DOWN: COPPER ALLOY

2 FINISH:  
 (SEE TABLE) 0.1 INCH GOLD PLATING OR GOLD FLASH OVER PdNi ON CONTACT AREA.  
 2.54 $\mu$ m MATTE-TIN PLATING ON SOLDER TAIL AREA.  
 1.27 $\mu$ m NICKEL UNDERPLATING OVERALL.

3 PCIE5, PART NUMBER AND DC PRINTED IN APPROPRIATE AREA OR OPPOSITE

4 SUCH CORE VOIDS PER MANUFACTURER'S CONVENIENCE

Bottom view of the connector showing dimensions: 0.15, KEY  $\phi$ , X, X, STE logo,  $\phi$  1.0 REF, N, 1.35 REF, POST  $\phi$ , 1.65 REF, 10.00, C, and 1.00.

Side view of the connector showing dimensions: 7.5 MAX, 11.25 MAX, 1.00, and note: ALL SOLDER TAILS AND HOLD DOWN.

SECTION X-X showing dimensions: 5.10±0.15, 3.75 MAX,  $\phi$  OF 7.5, ACCEPTED 1.57 PCB, 0.80±0.15, 4.40±0.20, 4.05±0.15, 3.40±0.15, 8.20±0.20.

|  |              |                           |  |  |
|--|--------------|---------------------------|--|--|
| THIS DRAWING IS A CONTROLLED DOCUMENT. |              | DWN SANDERS YAN 22OCT2019 | TE Connectivity                                |  |
| DIMENSIONS: mm                         |              | CHK MIKE CHEN 22OCT2019   |  |  |
| TOLERANCES UNLESS OTHERWISE SPECIFIED: |              | APVD HOPE LU 22OCT2019    | NAME PCI EXPRESS CARD EDGE CONNECTOR GEN5, STD |  |
| 0 PLC ±                                | 1 PLC ±0.3   | PRODUCT SPEC 108-160247   | SIZE CAGE CODE DRAWING NO RESTRICTED TO        |  |
| 2 PLC ±0.20                            | 3 PLC ±0.050 | APPLICATION SPEC -        | A200779 C-2364427                              |  |
| 4 PLC ±                                | ANGLES ±     | WEIGHT -                  | SCALE 6:1 SHEET 1 OF 7 REV D                   |  |
| FINISH                                 |              | CUSTOMER DRAWING          |  |  |

1471-9 (3/13)

THIS DRAWING IS UNPUBLISHED. RELEASED FOR PUBLICATION 20  
 © COPYRIGHT 20 BY - ALL RIGHTS RESERVED.

| REVISIONS |     |             |      |      |
|-----------|-----|-------------|------|------|
| P         | LTR | DESCRIPTION | DATE | APVD |
| -         | -   | SEE SHEET 1 | -    | -    |
|           |     |             |      |      |
|           |     |             |      |      |

| TYPE        | L * W * H (TRAY)       | PRECIOUS PLATING THICKNESS (TOTAL) | W             | V   | J    | D  | N  | C     | B  | A     | POS. | PART NUMBER |
|-------------|------------------------|------------------------------------|---------------|-----|------|----|----|-------|----|-------|------|-------------|
| TAPE & REEL | 88 X 13.92 X 24(W*D*P) | 30u"                               | 53.5          | 8.5 | 28   | 58 | 37 | 40.15 | 56 | 38.65 | 98   | 7-2364427-9 |
| SOFT TRAY   | 328 X 135 X 23.2       | 30u"                               | 86.5          | 8   | 44.5 | 91 | 70 | 73.15 | 89 | 71.65 | 164  | 7-2364427-8 |
| TAPE & REEL | 88 X 13.92 X 24(W*D*P) | 30u"                               | 53.5          | 8   | 28   | 58 | 37 | 40.15 | 56 | 38.65 | 98   | 7-2364427-7 |
| HARD TRAY   | 300 X 200 X 19.3       | 30u"                               | 10.0          | 8   | 44.5 | 91 | 70 | 73.15 | 89 | 71.65 | 164  | 8-2364427-4 |
| HARD TRAY   | 323 X 136 X 19         | 30u"                               | WITHOUT MYLAR |     | 44.5 | 91 | 70 | 73.15 | 89 | 71.65 | 164  | 6-2364427-9 |
| HARD TRAY   | 323 X 136 X 19         | 30u"                               | 86.5          | 8.5 | 44.5 | 91 | 70 | 73.15 | 89 | 71.65 | 164  | 6-2364427-8 |
| HARD TRAY   | 323 X 136 X 19         | 30u"                               | 53            | 8.5 | 28   | 58 | 37 | 40.15 | 56 | 38.65 | 98   | 6-2364427-7 |
| TAPE & REEL | 56 X 14.15 X 24(W*D*P) | 30u"                               | 30            | 8.5 | 19.5 | 41 | 20 | 23.15 | 39 | 21.65 | 64   | 6-2364427-6 |
| TAPE & REEL | 44 X 14.15 X 24(W*D*P) | 30u"                               | 22            | 8.5 | 12.5 | 27 | 6  | 9.15  | 25 | 7.65  | 36   | 6-2364427-5 |
| HARD TRAY   | 330 X 235 X 19.3       | 30u"                               | 45.0          | 8   | 44.5 | 91 | 70 | 73.15 | 89 | 71.65 | 164  | 7-2364427-4 |
| HARD TRAY   | 330 X 235 X 19.3       | 30u"                               | 86.5          | 8   | 44.5 | 91 | 70 | 73.15 | 89 | 71.65 | 164  | 5-2364427-8 |
| HARD TRAY   | 330 X 235 X 19.3       | 30u"                               | 53.5          | 8   | 28   | 58 | 37 | 40.15 | 56 | 38.65 | 98   | 5-2364427-7 |
| SOFT TRAY   | 338 X 235 X 20.3       | 30u"                               | 36.5          | 8   | 19.5 | 41 | 20 | 23.15 | 39 | 21.65 | 64   | 5-2364427-6 |
| SOFT TRAY   | TBD                    | 30u"                               | 22.5          | 8   | 12.5 | 27 | 6  | 9.15  | 25 | 7.65  | 36   | 5-2364427-5 |
| HARD TRAY   | 330 X 235 X 19.3       | 30u"                               | 10.0          | 8   | 44.5 | 91 | 70 | 73.15 | 89 | 71.65 | 164  | 5-2364427-4 |
| HARD TRAY   | 330 X 235 X 19.3       | 30u"                               | 10.0          | 8   | 28   | 58 | 37 | 40.15 | 56 | 38.65 | 98   | 5-2364427-3 |
| SOFT TRAY   | 338 X 235 X 20.3       | 30u"                               | 10.0          | 8   | 19.5 | 41 | 20 | 23.15 | 39 | 21.65 | 64   | 5-2364427-2 |
| SOFT TRAY   | TBD                    | 30u"                               | 10.0          | 8   | 12.5 | 27 | 6  | 9.15  | 25 | 7.65  | 36   | 5-2364427-1 |
| HARD TRAY   | 330 X 235 X 19.3       | 15u"                               | 86.5          | 8   | 44.5 | 91 | 70 | 73.15 | 89 | 71.65 | 164  | 4-2364427-8 |
| HARD TRAY   | 330 X 235 X 19.3       | 15u"                               | 53.5          | 8   | 28   | 58 | 37 | 40.15 | 56 | 38.65 | 98   | 4-2364427-7 |
| SOFT TRAY   | 338 X 235 X 20.3       | 15u"                               | 36.5          | 8   | 19.5 | 41 | 20 | 23.15 | 39 | 21.65 | 64   | 4-2364427-6 |
| SOFT TRAY   | TBD                    | 15u"                               | 22.5          | 8   | 12.5 | 27 | 6  | 9.15  | 25 | 7.65  | 36   | 4-2364427-5 |
| HARD TRAY   | 330 X 235 X 19.3       | 15u"                               | 10.0          | 8   | 44.5 | 91 | 70 | 73.15 | 89 | 71.65 | 164  | 4-2364427-4 |
| HARD TRAY   | 330 X 235 X 19.3       | 15u"                               | 10.0          | 8   | 28   | 58 | 37 | 40.15 | 56 | 38.65 | 98   | 4-2364427-3 |
| SOFT TRAY   | 338 X 235 X 20.3       | 15u"                               | 10.0          | 8   | 19.5 | 41 | 20 | 23.15 | 39 | 21.65 | 64   | 4-2364427-2 |
| SOFT TRAY   | TBD                    | 15u"                               | 10.0          | 8   | 12.5 | 27 | 6  | 9.15  | 25 | 7.65  | 36   | 4-2364427-1 |
| HARD TRAY   | 330 X 235 X 19.3       | G/F                                | 86.5          | 8   | 44.5 | 91 | 70 | 73.15 | 89 | 71.65 | 164  | 3-2364427-8 |
| HARD TRAY   | 330 X 235 X 19.3       | G/F                                | 53.5          | 8   | 28   | 58 | 37 | 40.15 | 56 | 38.65 | 98   | 3-2364427-7 |
| SOFT TRAY   | 338 X 235 X 20.3       | G/F                                | 36.5          | 8   | 19.5 | 41 | 20 | 23.15 | 39 | 21.65 | 64   | 3-2364427-6 |
| SOFT TRAY   | TBD                    | G/F                                | 22.5          | 8   | 12.5 | 27 | 6  | 9.15  | 25 | 7.65  | 36   | 3-2364427-5 |
| HARD TRAY   | 330 X 235 X 19.3       | G/F                                | 10.0          | 8   | 44.5 | 91 | 70 | 73.15 | 89 | 71.65 | 164  | 3-2364427-4 |
| HARD TRAY   | 330 X 235 X 19.3       | G/F                                | 10.0          | 8   | 28   | 58 | 37 | 40.15 | 56 | 38.65 | 98   | 3-2364427-3 |
| SOFT TRAY   | 338 X 235 X 20.3       | G/F                                | 10.0          | 8   | 19.5 | 41 | 20 | 23.15 | 39 | 21.65 | 64   | 3-2364427-2 |
| SOFT TRAY   | TBD                    | G/F                                | 10.0          | 8   | 12.5 | 27 | 6  | 9.15  | 25 | 7.65  | 36   | 3-2364427-1 |
| HARD TRAY   | 330 X 235 X 19.3       | 30u"                               | NA            |     | 44.5 | 91 | 70 | 73.15 | 89 | 71.65 | 164  | 2-2364427-4 |
| HARD TRAY   | 330 X 235 X 19.3       | 30u"                               | NA            |     | 28   | 58 | 37 | 40.15 | 56 | 38.65 | 98   | 2-2364427-3 |
| SOFT TRAY   | 338 X 235 X 20.3       | 30u"                               | NA            |     | 19.5 | 41 | 20 | 23.15 | 39 | 21.65 | 64   | 2-2364427-2 |
| SOFT TRAY   | TBD                    | 30u"                               | NA            |     | 12.5 | 27 | 6  | 9.15  | 25 | 7.65  | 36   | 2-2364427-1 |
| HARD TRAY   | 330 X 235 X 19.3       | 15u"                               | NA            |     | 44.5 | 91 | 70 | 73.15 | 89 | 71.65 | 164  | 1-2364427-4 |
| HARD TRAY   | 330 X 235 X 19.3       | 15u"                               | NA            |     | 28   | 58 | 37 | 40.15 | 56 | 38.65 | 98   | 1-2364427-3 |
| SOFT TRAY   | 338 X 235 X 20.3       | 15u"                               | NA            |     | 19.5 | 41 | 20 | 23.15 | 39 | 21.65 | 64   | 1-2364427-2 |
| SOFT TRAY   | TBD                    | 15u"                               | NA            |     | 12.5 | 27 | 6  | 9.15  | 25 | 7.65  | 36   | 1-2364427-1 |
| HARD TRAY   | 330 X 235 X 19.3       | G/F                                | NA            |     | 44.5 | 91 | 70 | 73.15 | 89 | 71.65 | 164  | 2364427-4   |
| HARD TRAY   | 330 X 235 X 19.3       | G/F                                | NA            |     | 28   | 58 | 37 | 40.15 | 56 | 38.65 | 98   | 2364427-3   |
| SOFT TRAY   | 338 X 235 X 20.3       | G/F                                | NA            |     | 19.5 | 41 | 20 | 23.15 | 39 | 21.65 | 64   | 2364427-2   |
| SOFT TRAY   | TBD                    | G/F                                | NA            |     | 12.5 | 27 | 6  | 9.15  | 25 | 7.65  | 36   | 2364427-1   |

D

THIS DRAWING IS A CONTROLLED DOCUMENT.

DWN SANDERS YAN 22OCT2019  
 CHK MIKE CHEN 22OCT2019  
 APVD HOPE LU 22OCT2019

**STE** TE Connectivity

NAME PCI EXPRESS CARD EDGE CONNECTOR GEN5, STD  
 PRODUCT SPEC 108-160247  
 APPLICATION SPEC -

SIZE A2 CAGE CODE 00779 DRAWING NO C-2364427 RESTRICTED TO -  
 WEIGHT -  
 CUSTOMER DRAWING SCALE 1:1 SHEET 2 OF 7 REV D

DIMENSIONS: mm  
 TOLERANCES UNLESS OTHERWISE SPECIFIED:  
 0 PLC ±0.3  
 1 PLC ±0.20  
 2 PLC ±0.20  
 3 PLC ±0.050  
 4 PLC ±  
 ANGLES ±  
 FINISH -

THIS DRAWING IS UNPUBLISHED. RELEASED FOR PUBLICATION 20  
 © COPYRIGHT 20 BY - ALL RIGHTS RESERVED.

| REVISIONS |     |             |      |      |
|-----------|-----|-------------|------|------|
| P         | LTR | DESCRIPTION | DATE | APVD |
| -         | -   | SEE SHEET 1 | -    | -    |
|           |     |             |      |      |
|           |     |             |      |      |

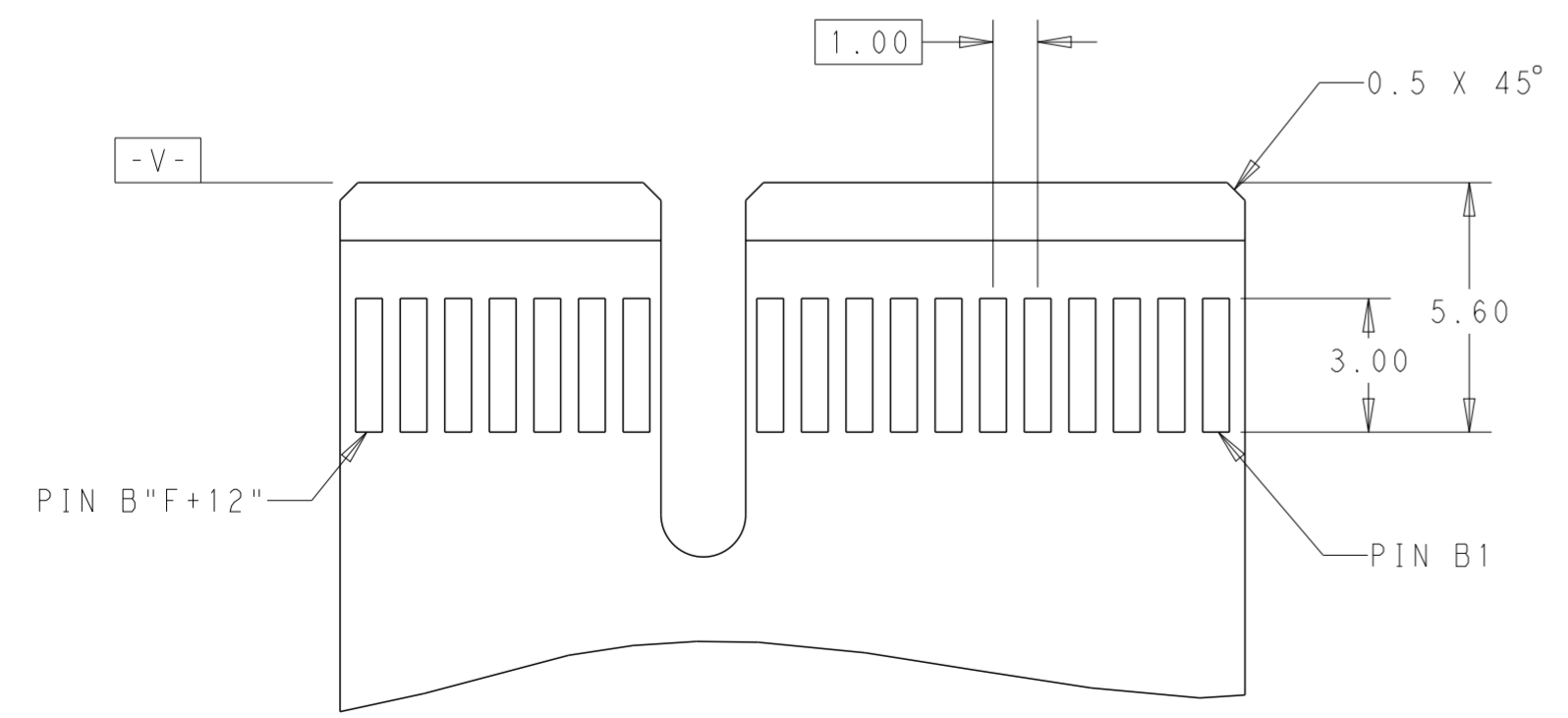
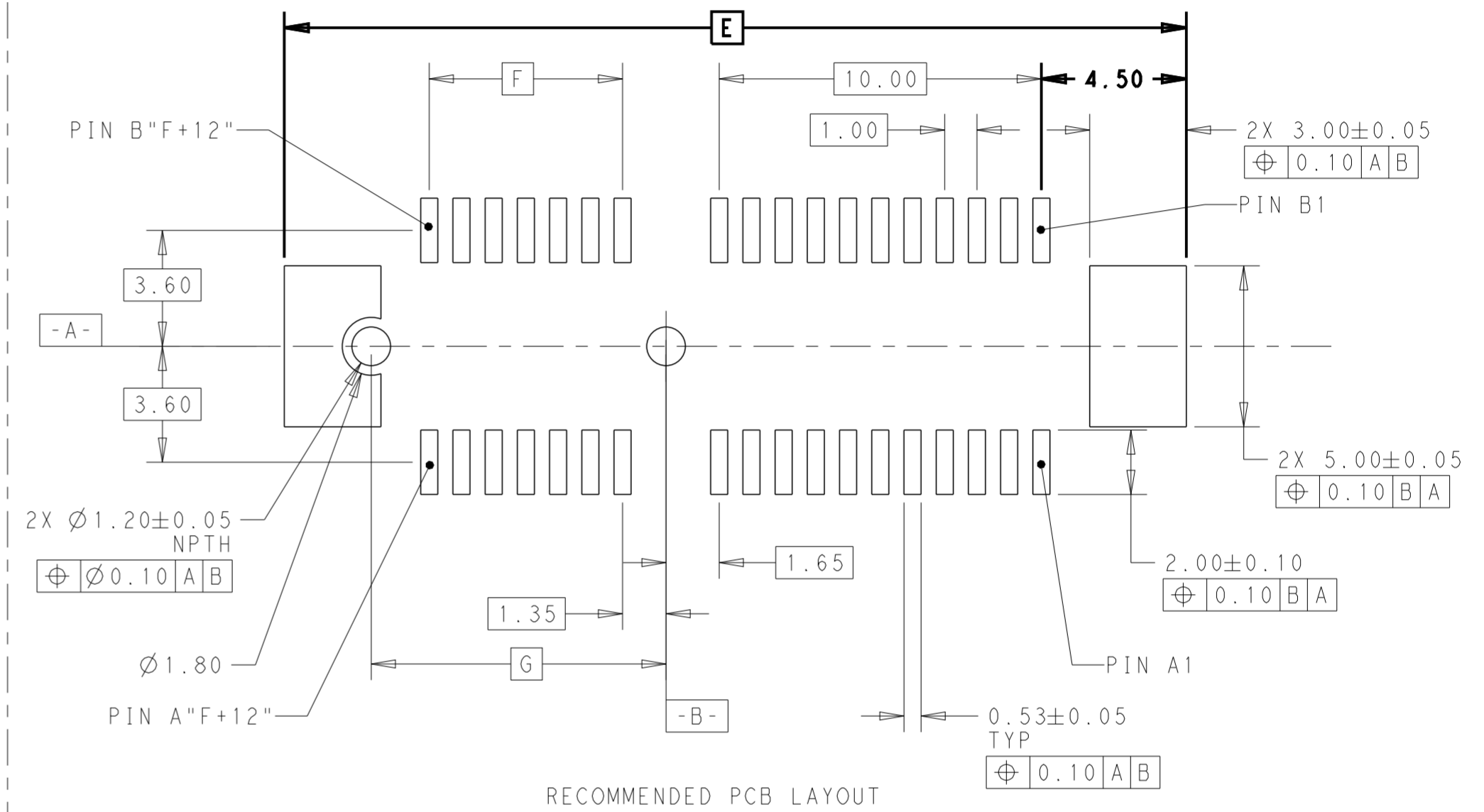
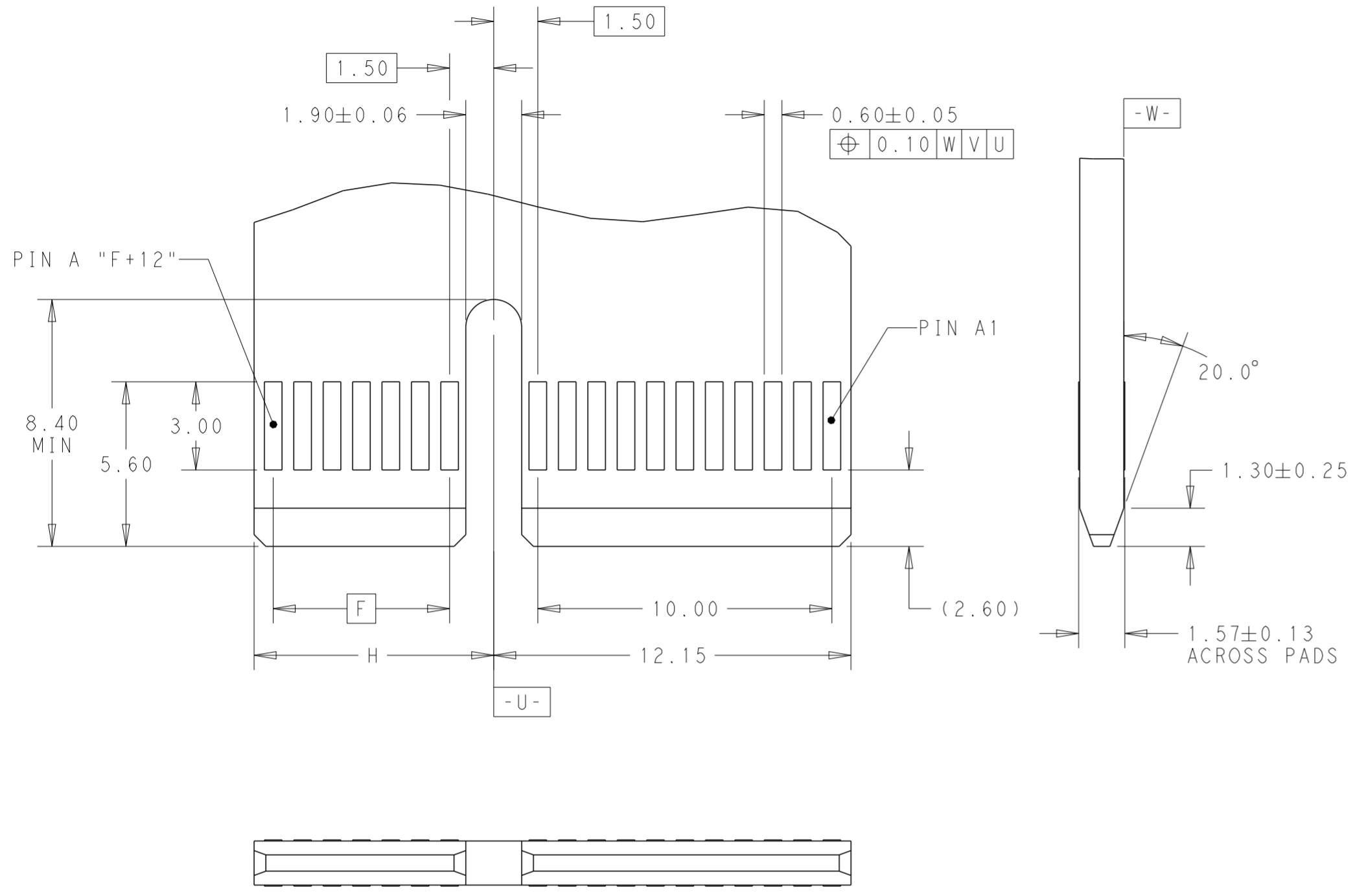

ADD-IN CARD EDGE-FINGER DIMENSION  
 DEFAULT TOLERANCE ±0.13

|      |        |        |        |        |
|------|--------|--------|--------|--------|
| 164  | 92.00  | 70     | 73.15  | 72.15  |
| 98   | 59.00  | 37     | 40.15  | 39.15  |
| 64   | 42.00  | 20     | 23.15  | 22.15  |
| 36   | 28.00  | 6      | 9.15   | 8.15   |
| POS. | DIM. E | DIM. F | DIM. G | DIM. H |

THIS DRAWING IS A CONTROLLED DOCUMENT.

|                   |   |  |   |
|-------------------|---|--|---|
| DIMENSIONS:<br>mm | TOLERANCES UNLESS OTHERWISE SPECIFIED:<br>0 PLC ±<br>1 PLC ±0.3<br>2 PLC ±0.20<br>3 PLC ±0.050<br>4 PLC ±<br>ANGLES ±<br>FINISH | DWN SANDERS, YAN 22OCT2019<br>CHK MIKE, CHEN 22OCT2019<br>APVD HOPE, LU 22OCT2019<br>PRODUCT SPEC 108-160247<br>APPLICATION SPEC -<br>WEIGHT - | NAME PCI EXPRESS CARD EDGE CONNECTOR GEN5, STD<br>SIZE A2<br>CAGE CODE 00779<br>DRAWING NO C-2364427<br>RESTRICTED TO - |
| MATERIAL -        | FINISH -  | CUSTOMER DRAWING   | SCALE 6:1 SHEET 3 OF 7 REV D  |

THIS DRAWING IS UNPUBLISHED. RELEASED FOR PUBLICATION 20  
 © COPYRIGHT 20 BY - ALL RIGHTS RESERVED.

| REVISIONS |     |             |      |      |
|-----------|-----|-------------|------|------|
| P         | LTR | DESCRIPTION | DATE | APVD |
| -         | -   | SEE SHEET 1 | -    | -    |
|           |     |             |      |      |
|           |     |             |      |      |

FRONT VIEW

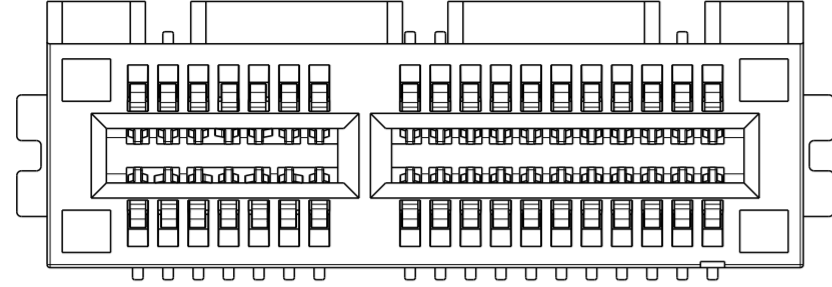

36POS AS SHOWN  
 SCALE: 4:1

FRONT VIEW

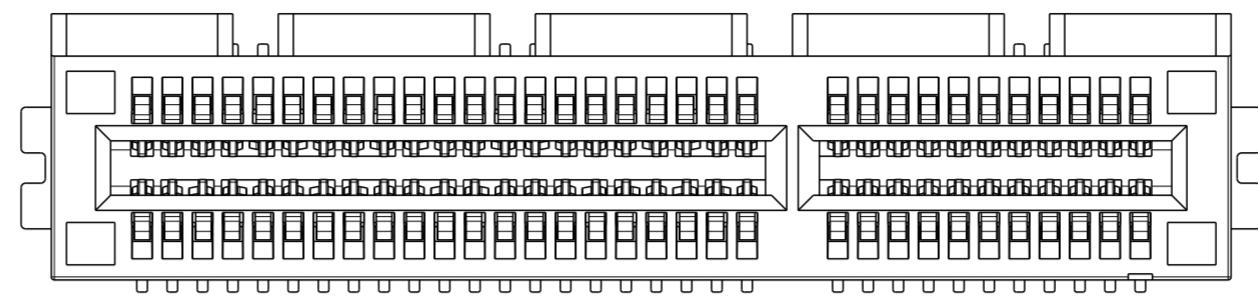

64POS AS SHOWN  
 SCALE: 4:1

FRONT VIEW

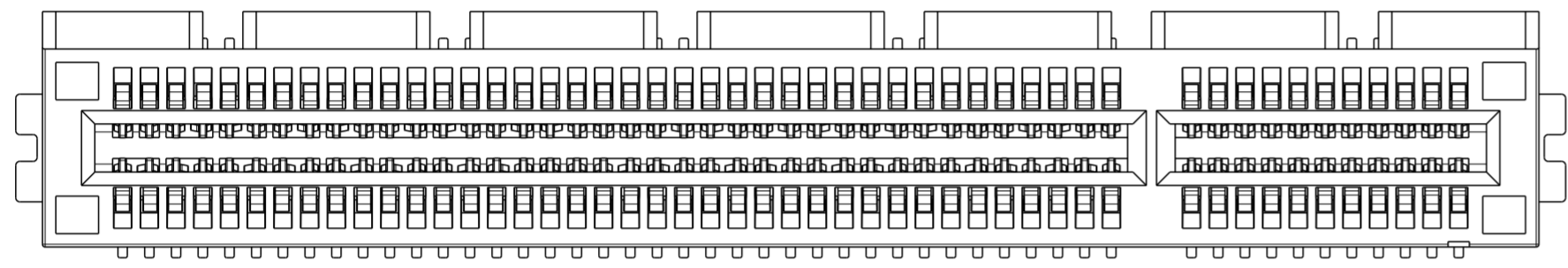

98POS AS SHOWN  
 SCALE: 4:1

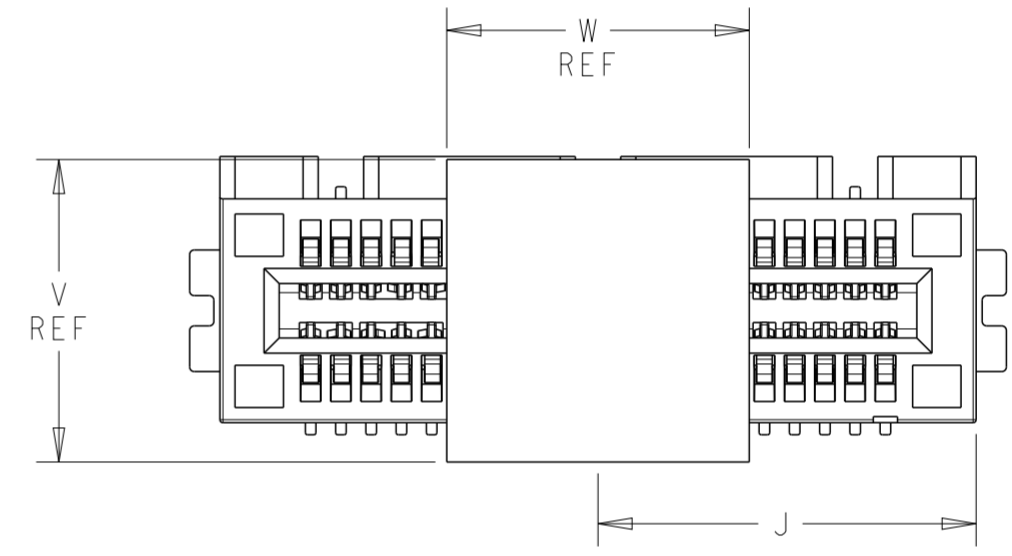

MYLAR SIZE  
 SCALE: 4:1

FRONT VIEW

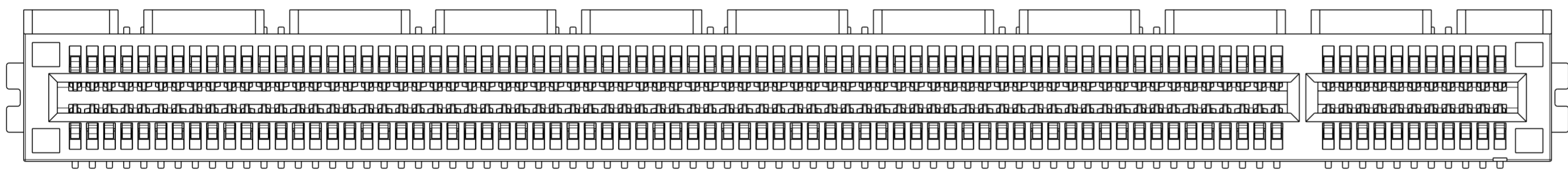

164POS AS SHOWN  
 SCALE: 4:1

|   |  |                                  |  |                        |
|---|--|----------------------------------|--|------------------------|
| THIS DRAWING IS A CONTROLLED DOCUMENT.  |  | DWN<br>SANDERS, YAN<br>22OCT2019 | TE Connectivity                                      |                        |
| DIMENSIONS:<br>mm   |  | CHK<br>MIKE, CHEN<br>22OCT2019   |  |                        |
| TOLERANCES UNLESS OTHERWISE SPECIFIED:  |  | APVD<br>HOPE, LU<br>22OCT2019    | NAME<br>PCI EXPRESS CARD EDGE CONNECTOR<br>GEN5, STD |                        |
| 0 PLC ±<br>1 PLC ±0.3<br>2 PLC ±0.20<br>3 PLC ±0.050<br>4 PLC ±<br>ANGLES ±<br>FINISH ± |  | PRODUCT SPEC<br>108-160247       | SIZE<br>A200779                                      | CAGE CODE<br>C-2364427 |
| MATERIAL  |  | APPLICATION SPEC                 | DRAWING NO   | RESTRICTED TO          |
| -   |  | WEIGHT                           | -  |                        |
| -   |  | CUSTOMER DRAWING                 | SCALE 6:1  | SHEET 4 OF 7 REV D     |

THIS DRAWING IS UNPUBLISHED. RELEASED FOR PUBLICATION 20  
 © COPYRIGHT 20 BY - ALL RIGHTS RESERVED.

| REVISIONS |     |             |      |      |
|-----------|-----|-------------|------|------|
| P         | LTR | DESCRIPTION | DATE | APVD |
| -         | -   | SEE SHEET 1 | -    | -    |
|           |     |             |      |      |
|           |     |             |      |      |

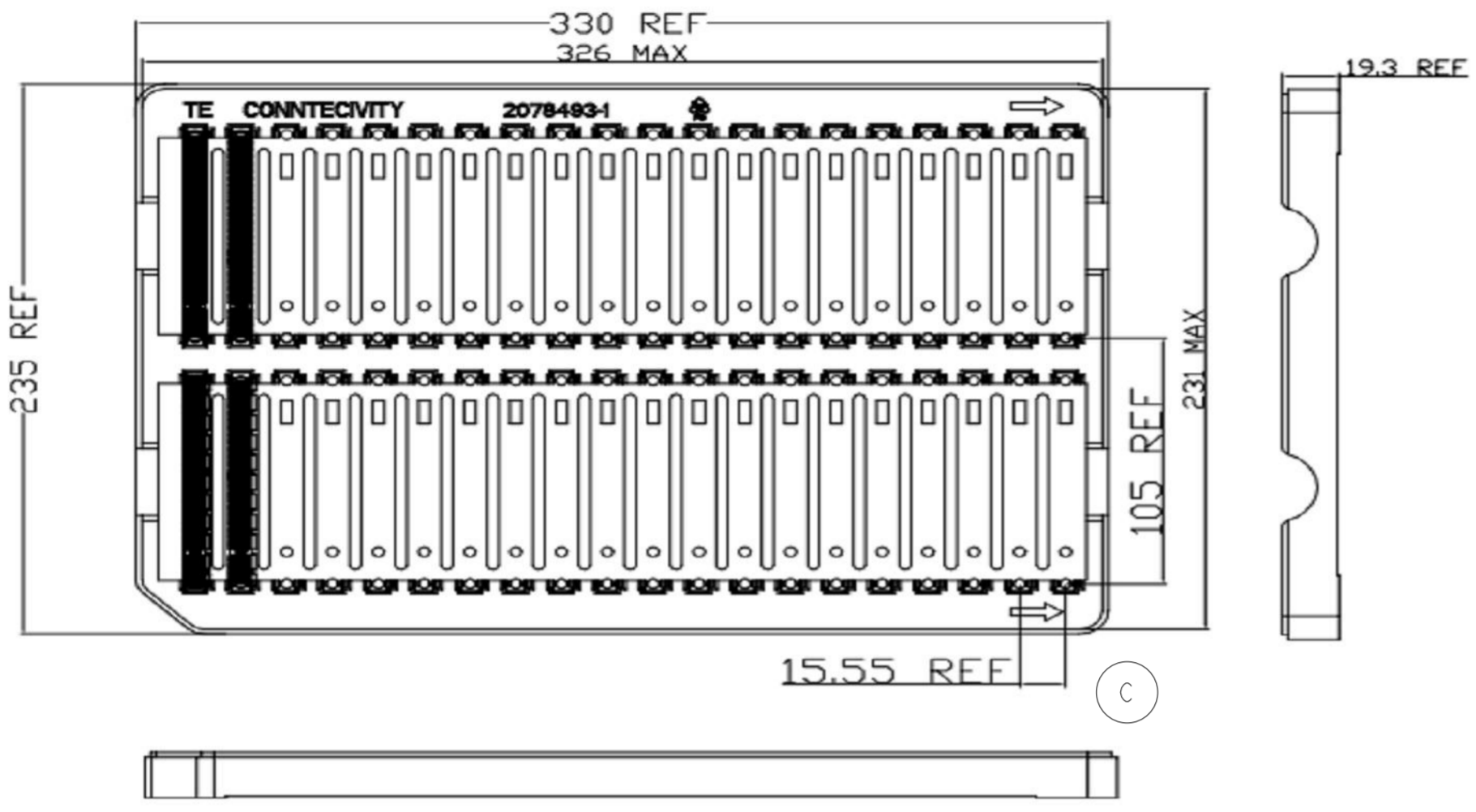

HARD TRAY: FOR 164POS  
 SCALE: 1:2

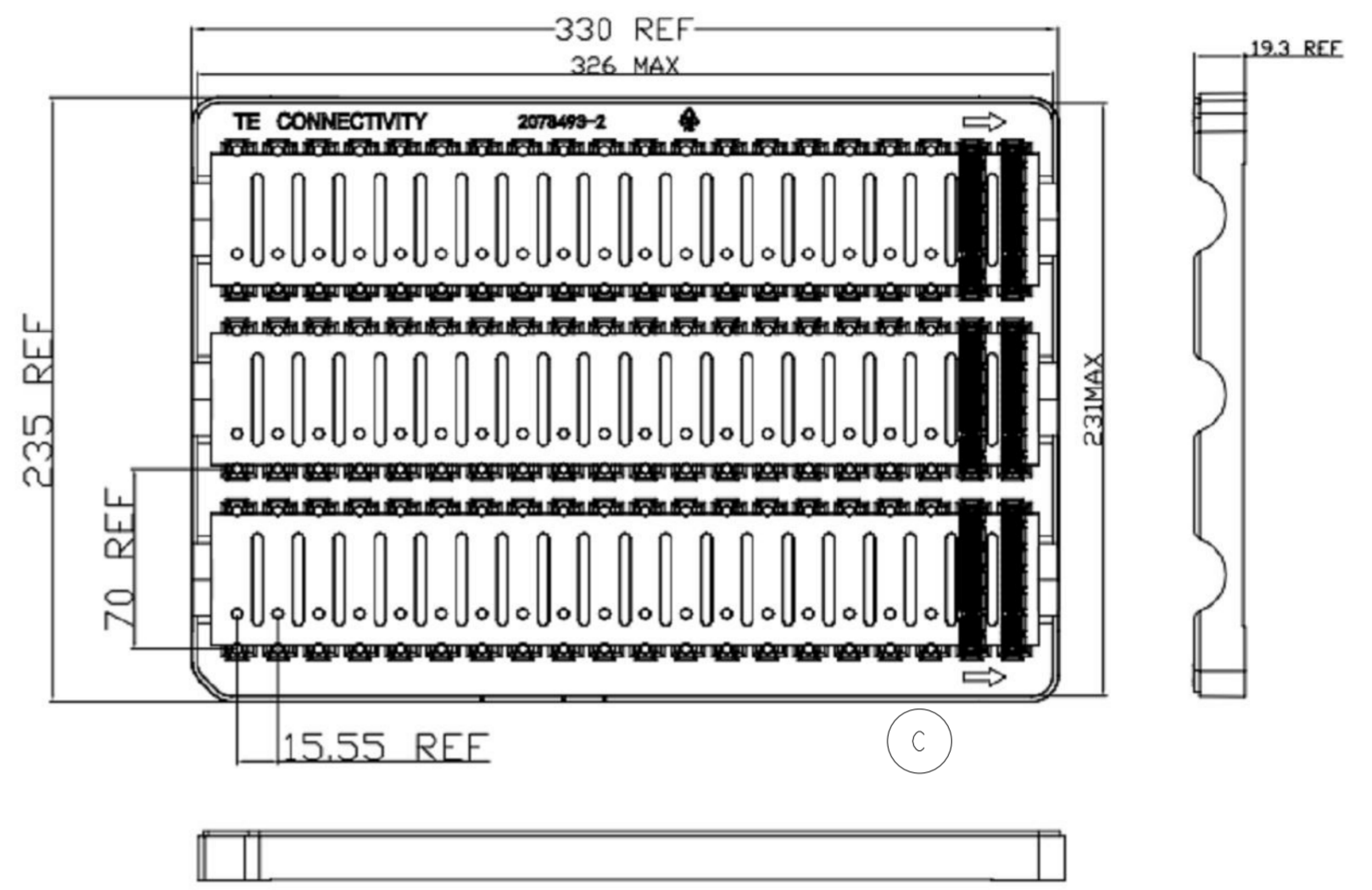

HARD TRAY: FOR 98POS  
 SCALE: 1:2

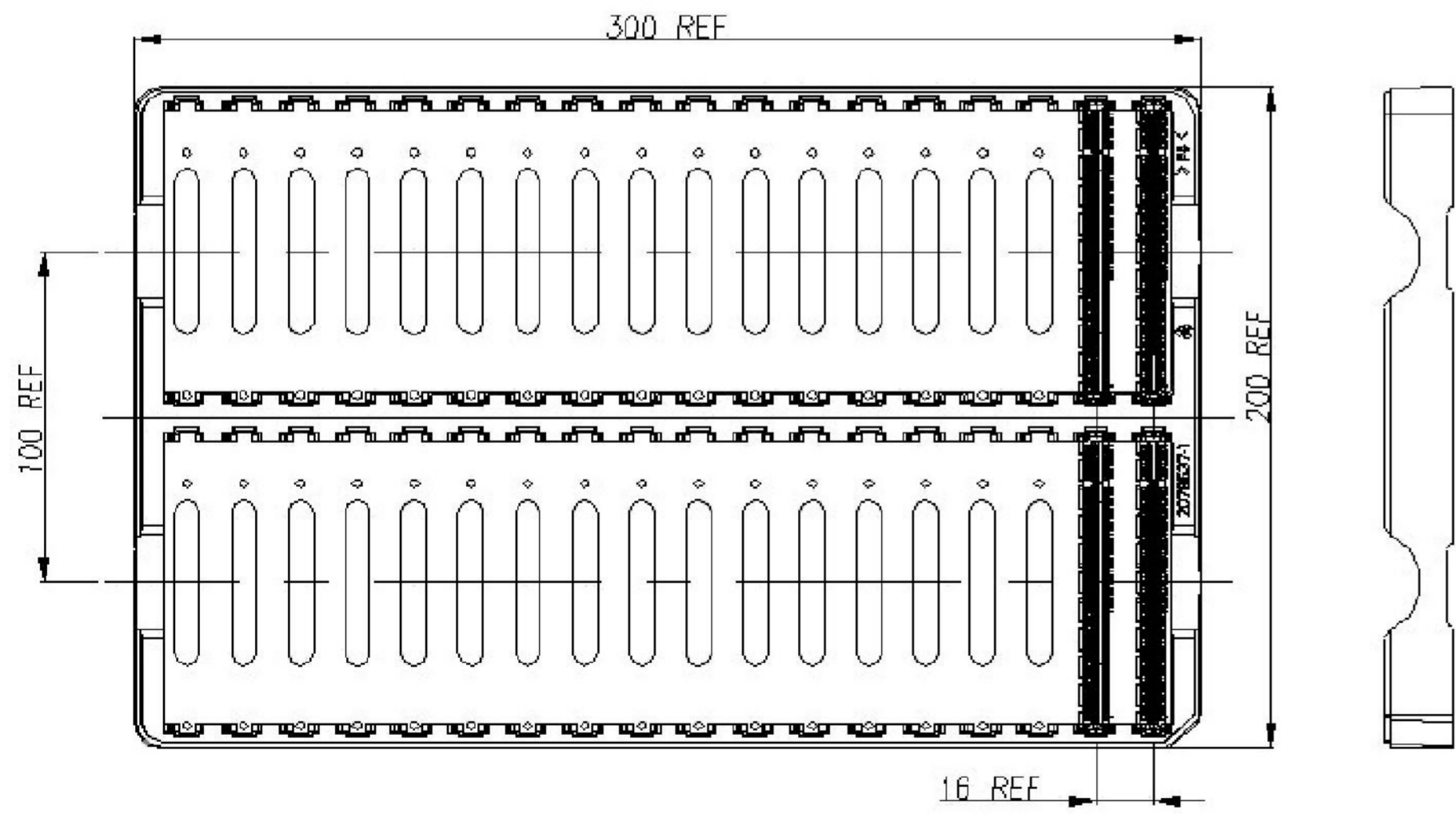

HARD TRAY: FOR 8-2364427-4 (164POS)  
 SCALE: 1:2

|  |              |                            |  |               |
|--|--------------|----------------------------|--|---------------|
| THIS DRAWING IS A CONTROLLED DOCUMENT. |              | DWN SANDERS, YAN 22OCT2019 |  |               |
|  |              | CHK MIKE, CHEN 22OCT2019   |  |               |
|  |              | APVD HOPE, LU 22OCT2019    | NAME PCI EXPRESS CARD EDGE CONNECTOR GEN5, STD |               |
| DIMENSIONS: mm                         |              | PRODUCT SPEC 108-160247    |  | SIZE          |
| TOLERANCES UNLESS OTHERWISE SPECIFIED: |              | APPLICATION SPEC           |  | CAGE CODE     |
| 0 PLC ±                                | 1 PLC ±0.3   | -                          |  | DRAWING NO    |
| 2 PLC ±0.20                            | 3 PLC ±0.050 | -                          |  | RESTRICTED TO |
| 4 PLC ±                                | ANGLES ±     | -                          |  | A200779       |
| MATERIAL                               |              | WEIGHT                     |  | C-2364427     |
| -                                      |              | -                          |  | SCALE 6:1     |
| -                                      |              | -                          |  | SHEET 5 OF 7  |
| -                                      |              | -                          |  | REV D         |

THIS DRAWING IS UNPUBLISHED. RELEASED FOR PUBLICATION 20  
 © COPYRIGHT 20 BY - ALL RIGHTS RESERVED.

| REVISIONS |     |             |      |      |
|-----------|-----|-------------|------|------|
| P         | LTR | DESCRIPTION | DATE | APVD |
| -         | -   | SEE SHEET 1 | -    | -    |
|           |     |             |      |      |
|           |     |             |      |      |

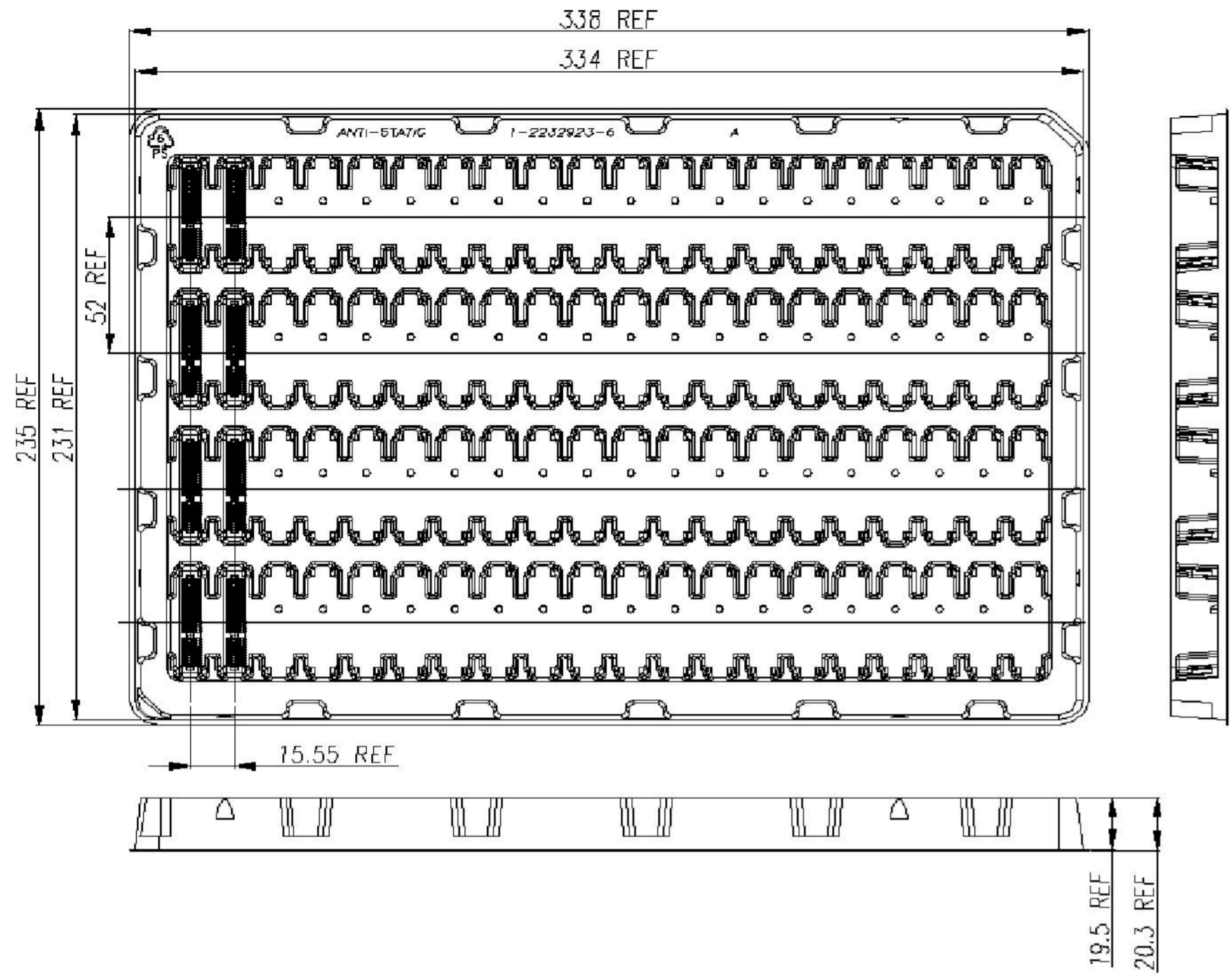

SOFT TRAY: FOR 64POS  
SCALE: 1:2

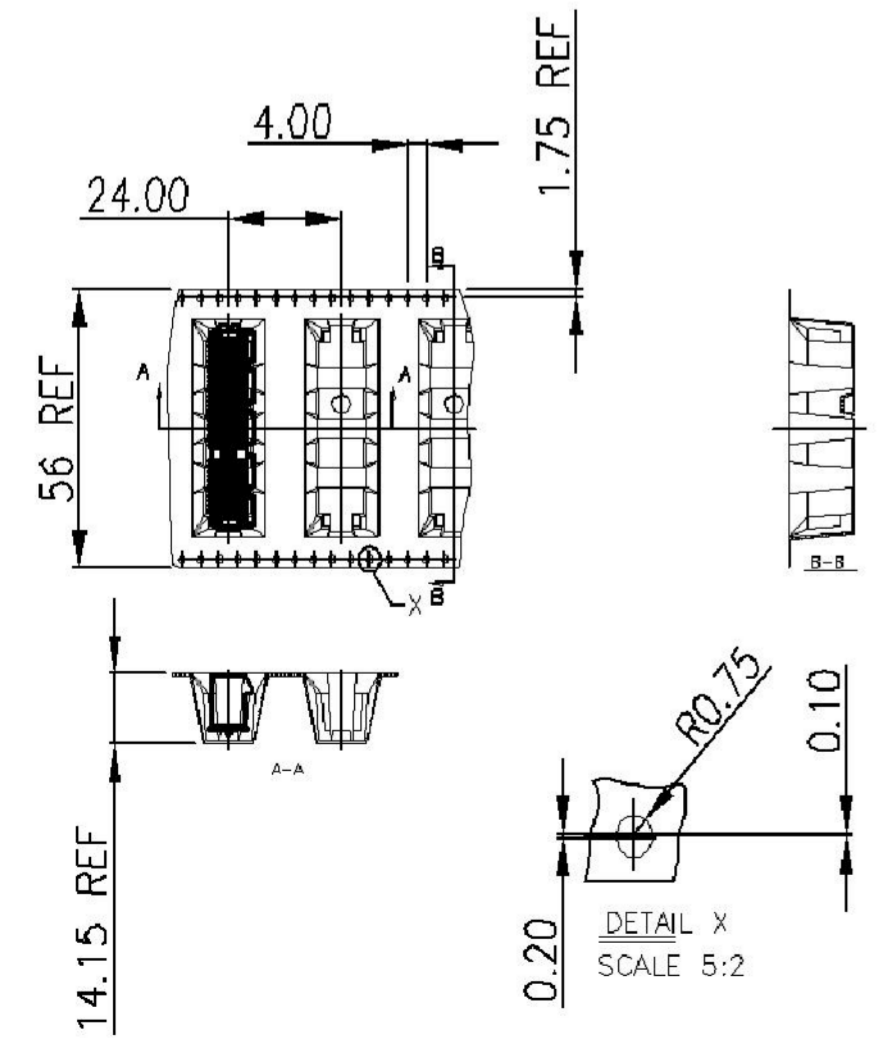

TAPE & REEL: FOR 6-2364427-6 (64POS)  
SCALE: 1:2

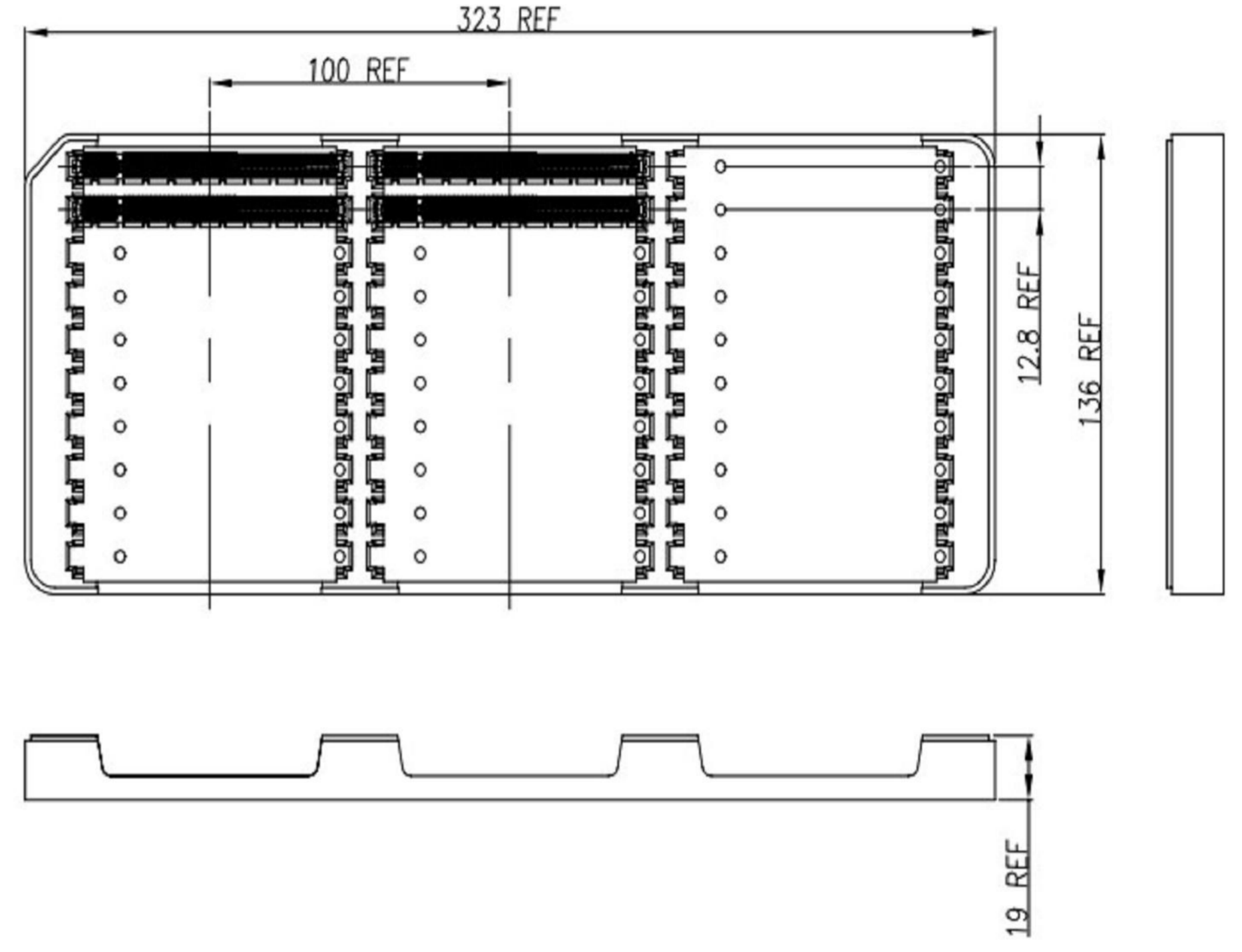

HARD TRAY: FOR 6-2364427-7/8/9 (164POS)  
SCALE: 1:2

|  |              |                           |   |  |
|--|--------------|---------------------------|---|--|
| THIS DRAWING IS A CONTROLLED DOCUMENT. |              | DWN SANDERS YAN 22OCT2019 |  TE Connectivity |  |
| DIMENSIONS: mm                         |              | CHK MIKE CHEN 22OCT2019   |   |  |
| TOLERANCES UNLESS OTHERWISE SPECIFIED: |              | APVD HOPE LU 22OCT2019    | NAME PCI EXPRESS CARD EDGE CONNECTOR GEN5, STD  |  |
| 0 PLC ±                                | 1 PLC ±0.3   | PRODUCT SPEC 108-160247   | SIZE CAGE CODE DRAWING NO RESTRICTED TO   |  |
| 2 PLC ±0.20                            | 3 PLC ±0.050 | APPLICATION SPEC -        | A200779 C-2364427   |  |
| 4 PLC ±                                | ANGLES ±     | WEIGHT -                  | SCALE 6:1 SHEET 6 OF 7 REV D  |  |
| FINISH -                               | -            | CUSTOMER DRAWING          |   |  |

THIS DRAWING IS UNPUBLISHED. RELEASED FOR PUBLICATION 20  
 © COPYRIGHT 20 BY - ALL RIGHTS RESERVED.

| REVISIONS |     |             |      |      |
|-----------|-----|-------------|------|------|
| P         | LTR | DESCRIPTION | DATE | APVD |
| -         | -   | SEE SHEET 1 | -    | -    |
|           |     |             |      |      |
|           |     |             |      |      |

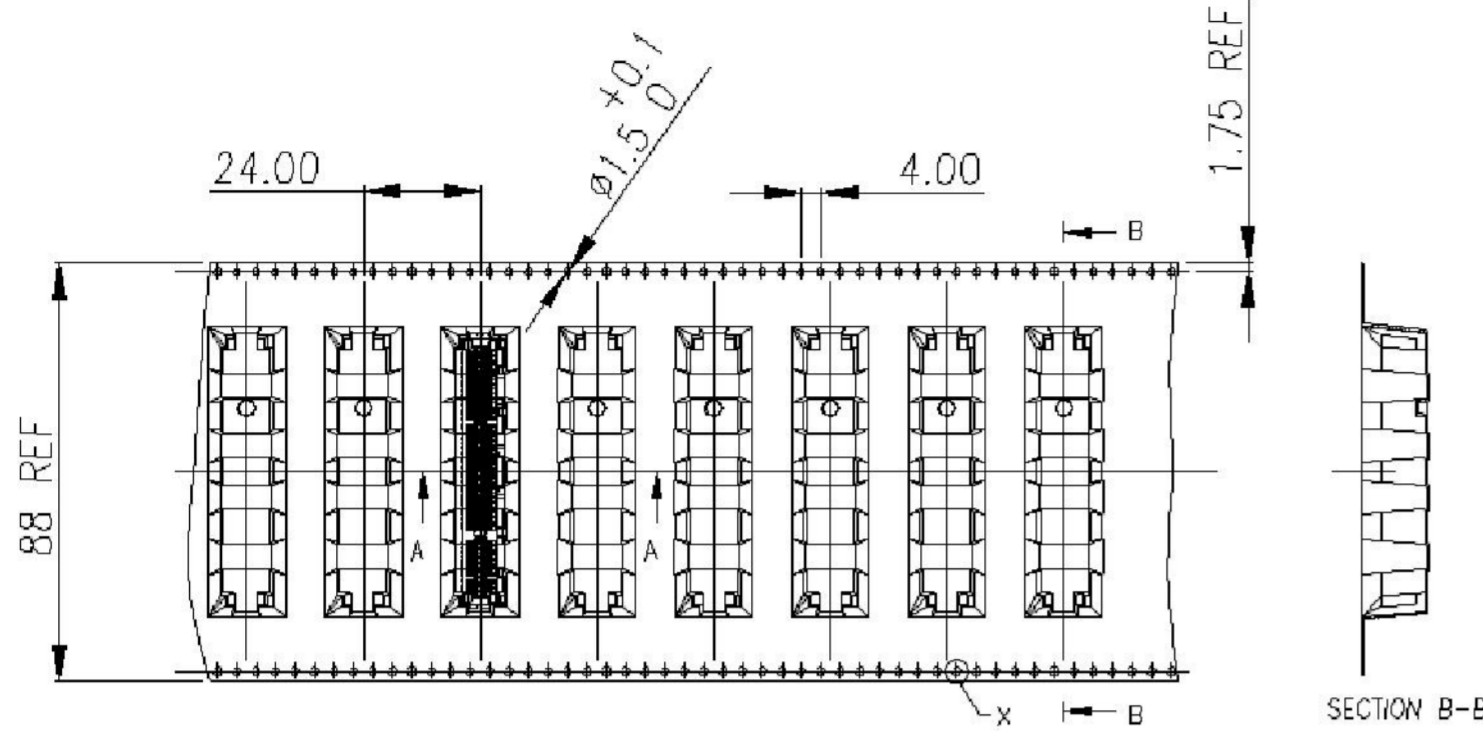

TAPE & REEL: FOR 7-2364427-7 AND 7-2364427-9 (98POS)  
 SCALE: 1:2

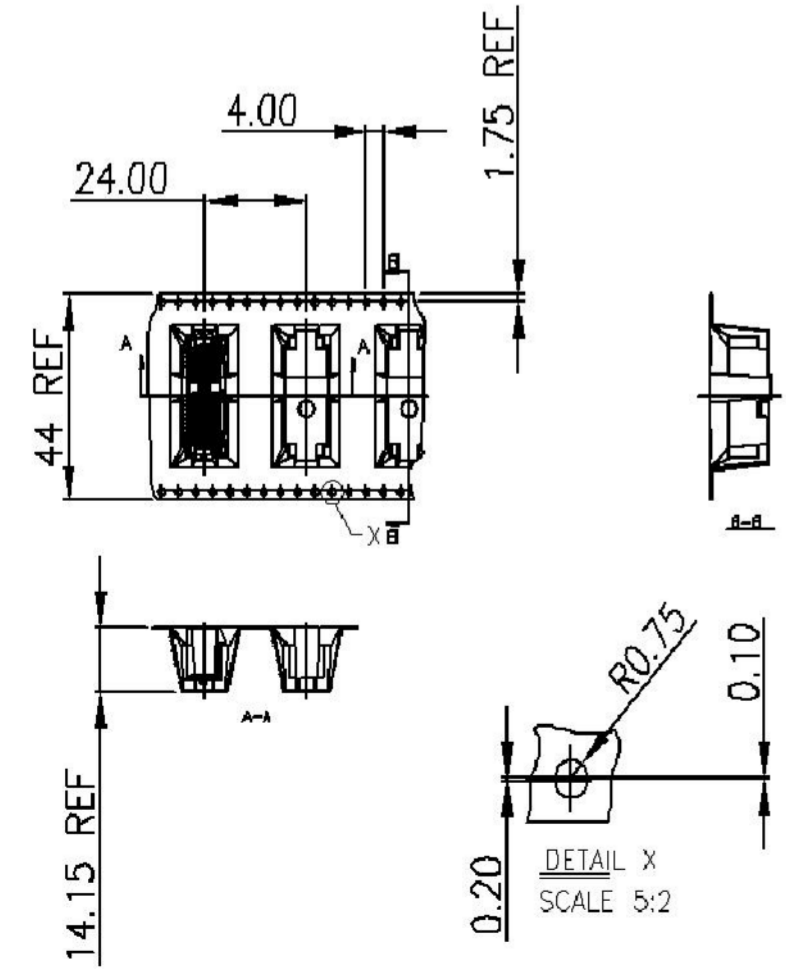

TAPE & REEL: FOR 6-2364427-5 (36POS)  
 SCALE: 1:2

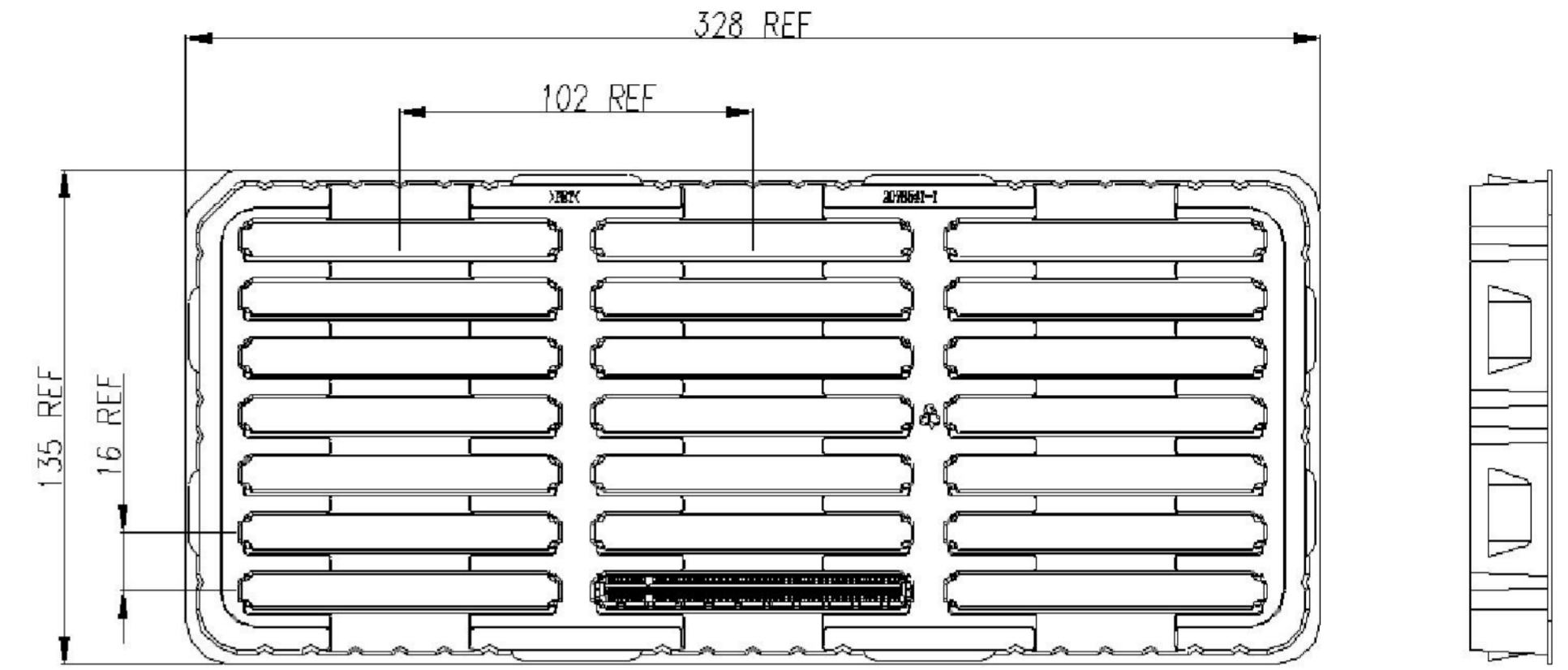

SOFT TRAY: FOR 7-2364427-8 (164POS)  
 SCALE: 1:2

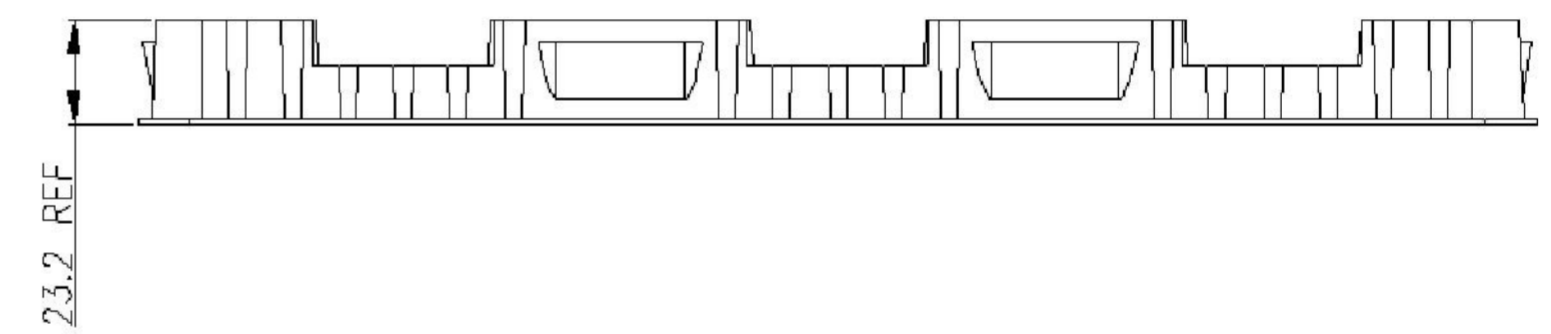

|  |              |                            |   |              |
|--|--------------|----------------------------|---|--------------|
| THIS DRAWING IS A CONTROLLED DOCUMENT. |              | DWN SANDERS, YAN 22OCT2019 |  TE Connectivity |              |
| DIMENSIONS: mm                         |              | CHK MIKE, CHEN 22OCT2019   |   |              |
| TOLERANCES UNLESS OTHERWISE SPECIFIED: |              | APVD HOPE, LU 22OCT2019    | NAME PCI EXPRESS CARD EDGE CONNECTOR GEN5, STD  |              |
| 0 PLC ±                                | 1 PLC ±0.3   | PRODUCT SPEC 108-160247    | SIZE  | CAGE CODE    |
| 2 PLC ±0.20                            | 3 PLC ±0.050 | APPLICATION SPEC           | A200779   | C-2364427    |
| 4 PLC ±                                | ANGLES ±     | FINISH                     | SCALE 6:1   | SHEET 7 OF 7 |
| MATERIAL                               | FINISH       | WEIGHT                     | CUSTOMER DRAWING  | REV D        |