

## GaAlAs T-1 Standard 3 $\phi$ Infrared Emitting Diode LTE-4206/LTE-4206C/LTE-4216/LTE-4216C

### Features

- Selected to specific on-line intensity and radiant intensity ranges.
- Low cost plastic end looking package.
- Mechanically and spectrally matched to the LTR-4206 series of phototransistor.
- The LTE-4206 series are made with Gallium Aluminum Arsenide window layer on Gallium Arsenide infrared emitting diodes.

### Description

The LTE-4206 series are high intensity Gallium Aluminum Arsenide infrared emitting diodes mounted in clear plastic end looking packages. The LTE-4206 series provides a broad range of intensity selection. Suffix C-smoke color lens.

### Package Dimensions

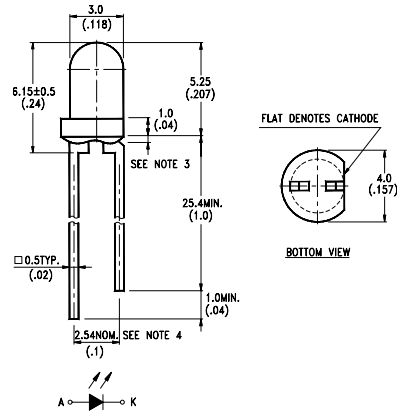

#### Notes:

1. All dimensions are in millimeters (inches).
2. Tolerance is  $\pm 0.25\text{mm}$  (.010") unless otherwise noted.
3. Protruded resin under flange is 1.5mm (.059") max.
4. Lead spacing is measured where the leads emerge from the package.
5. Specifications are subject to change without notice.

### Absolute Maximum Ratings at $T_a=25^\circ\text{C}$

Parameter	Maximum Rating	Unit
Power Dissipation	90	mW
Peak forward Current (300pps, 10 $\mu$ s pulse)	1	A
Continuous Forward Current	60	mA
Reverse Voltage	5	V
Operating Temperature Range	-40°C to +85°C	
Storage Temperature Range	-55°C to +100°C	
Lead Soldering Temperature [1.6mm (.063 in.) from body]	260°C for 5 Seconds	

### Electrical Optical Characteristics at $T_a=25^\circ\text{C}$

Parameter	Symbol	Min.	Typ.	Max.	Unit	Test Condition
*Aperture Radiant Incidence	Ee	0.3	0.7		mW/cm <sup>2</sup>	I <sub>F</sub> =20mA
Radiant Intensity	I <sub>e</sub>	2.25	5.26		mW/sr	I <sub>F</sub> =20mA
Peak Emission Wavelength	$\lambda$ Peak		940		nm	I <sub>F</sub> =20mA
Spectral Line Half-Width	$\Delta\lambda$		50		nm	I <sub>F</sub> =20mA
Forward Voltage	V <sub>F</sub>		1.2	1.6	V	I <sub>F</sub> =20mA
Reverse Current	I <sub>R</sub>			100	$\mu$ A	V <sub>R</sub> =5V
View Angle (See Fig.6)	2 $\theta$ 1/2		20		deg	

Note: \*Ee is a measurement of the average radiant incidence upon a sensing area 1cm<sup>2</sup> in perpendicular to and centered on the mechanical axis of the lens and 26.8mm from lens.

# Typical Electrical/Optical Characteristic Curves (25°C Ambient Temperature Unless Otherwise Noted)

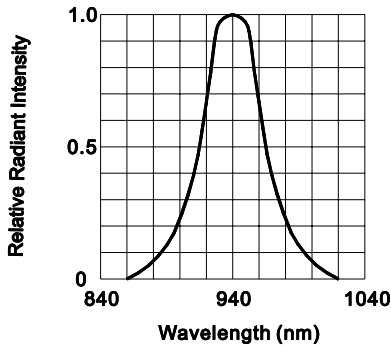

FIG.1 SPECTRAL DISTRIBUTION

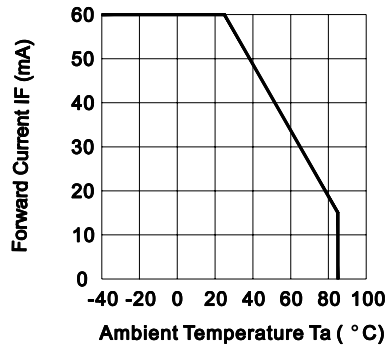

FIG.2 FORWARD CURRENT VS. AMBIENT TEMPERATURE

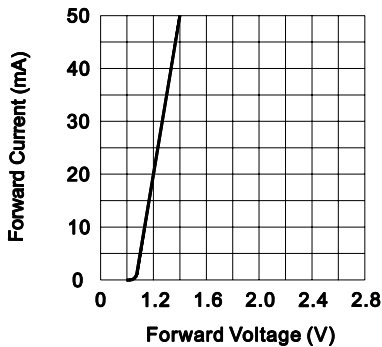

FIG.3 FORWARD CURRENT VS. FORWARD VOLTAGE

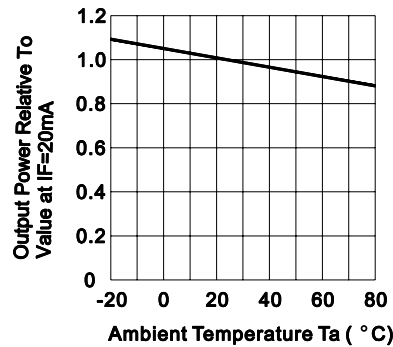

FIG.4 RELATIVE RADIANT INTENSITY VS. AMBIENT TEMPERATURE

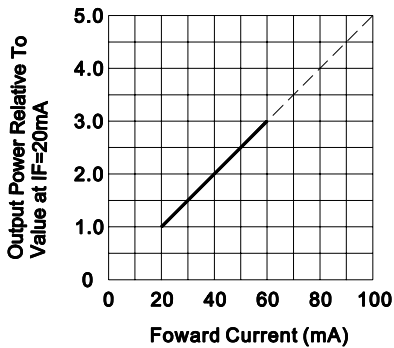

FIG.5 RELATIVE RADIANT INTENSITY VS. FORWARD CURRENT

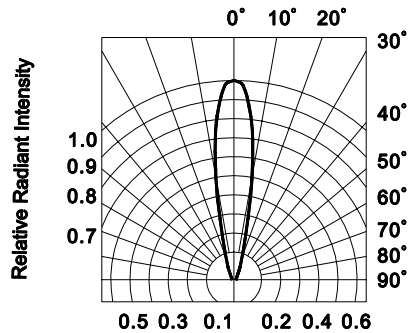

FIG.6 RADIATION DIAGRAM