

LQH2MPZ4R7MGR#

“#” at the end indicates the package specification code.

0806(inch) / 2016(mm) size, 0.95 mm max height, low DC resistance inductor.



< List of part numbers with package codes >
LQH2MPZ4R7MGRL

Applications

Unsuitable Applications	Please be sure to read and comply with these "Precautions for use."
Specific Applications	Consumer equipment, Automotive infotainment/comfort equipment, Medical equipment [GHTF A/B/C] except for implant & surgery & auto injector, Industrial equipment except for transportation & facility & energy equipment Please refer to Our Website and specifications, etc. for information about the performance, functions, quality, management, and safety required for the above applications, and use Products after confirming the performance and reliability of the actual Product.
Recommended Applications	Automotive infotainment/comfort equipment

Appearance & Shape

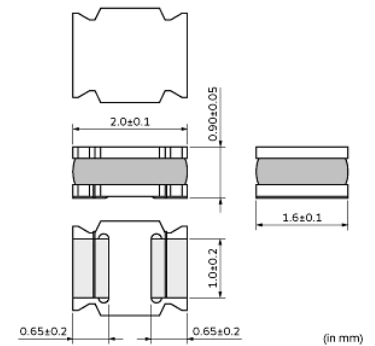
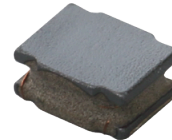

Attention

- This datasheet is downloaded from the website of Murata Manufacturing Co., Ltd. Therefore, its specifications are subject to change or our products in it may be discontinued without advance notice. Please check with our sales representatives or product engineers before ordering.
- This datasheet has only typical specifications because there is no space for detailed specifications. Therefore, please review our product specifications or consult the approval sheet for product specifications before ordering.

LQH2MPZ4R7MGR#

“#” at the end indicates the package specification code.



Notices

When rated current is applied to the products, inductance will be within $\pm 30\%$ of initial inductance value range. Keep the temperature (ambient temperature plus self-generation of heat) under 125°C . When rated current is applied to the products, temperature rise caused by self-generated heat shall be limited to 40°C max (ambient temperature 85°C max). When rated current is applied to the products, temperature rise caused by self-generated heat shall be limited to 20°C max (ambient temperature 85°C to 105°C).



References

Packaging	Specifications	Standard Packing Quantity
L	180Embossed Tape	3000

Mass (typ.)	
1 piece	0.01g

Attention

- 1.This datasheet is downloaded from the website of Murata Manufacturing Co., Ltd. Therefore, it's specifications are subject to change or our products in it may be discontinued without advance notice. Please check with our sales representatives or product engineers before ordering.
- 2.This datasheet has only typical specifications because there is no space for detailed specifications.
Therefore, please review our product specifications or consult the approval sheet for product specifications before ordering.

LQH2MPZ4R7MGR#

“#” at the end indicates the package specification code.



Specifications

L size	2.0±0.1mm
W size	1.6±0.1mm
T size	0.9±0.05mm
Size code inch (mm)	0806 (2016)
Inductance	4.7μH±20%
Inductance Test Frequency	1MHz
Rated current (Isat) (Based on Inductance change)	870mA
Rated current (Itemp) (Based on Temperature rise)	580mA(Ambient temp.85°C) 340mA(Ambient temp.105°C)
Max. of DC resistance	0.72Ω
DC resistance	0.60Ω±20%
Operating Temperature Range (Self-temperature rise is included)	-40°C to 125°C
Operating Temperature Range(Self-temperature rise is not included)	-40°C to 105°C
Class of magnetic shield	Shielded (Ferrite Core)
Self resonance frequency (min.)	40MHz
Brand	Murata
Series	LQH2MPZ_GR

Attention

- 1.This datasheet is downloaded from the website of Murata Manufacturing Co., Ltd. Therefore, it's specifications are subject to change or our products in it may be discontinued without advance notice. Please check with our sales representatives or product engineers before ordering.
- 2.This datasheet has only typical specifications because there is no space for detailed specifications.
Therefore, please review our product specifications or consult the approval sheet for product specifications before ordering.

LQH2MPZ4R7MGR#

“#” at the end indicates the package specification code.



Characteristic Data

The charts below may show another part number which shares its characteristics.

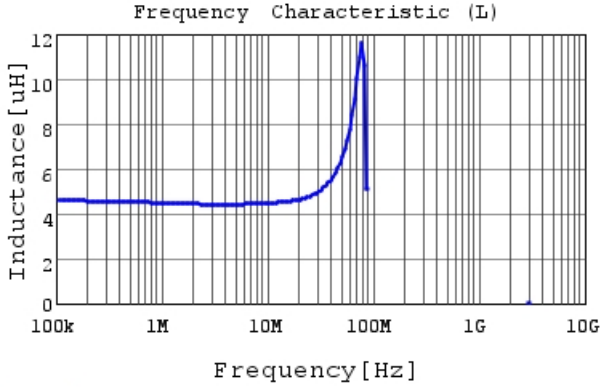

LQH2MPZ4R7MGR L

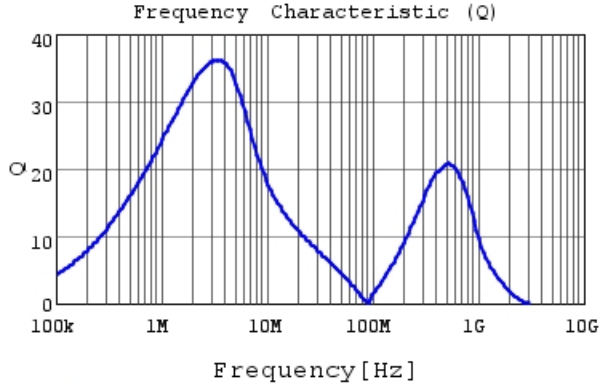

LQH2MPZ4R7MGR Q

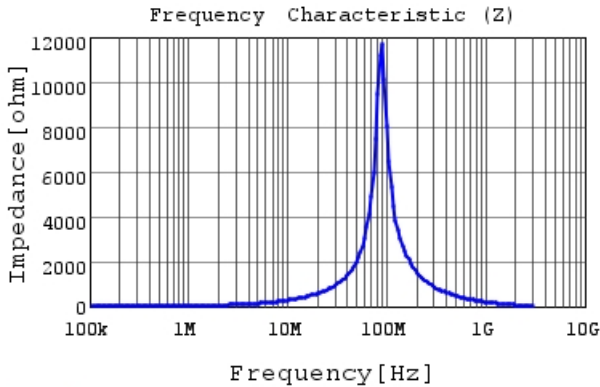

LQH2MPZ4R7MGR |Z|

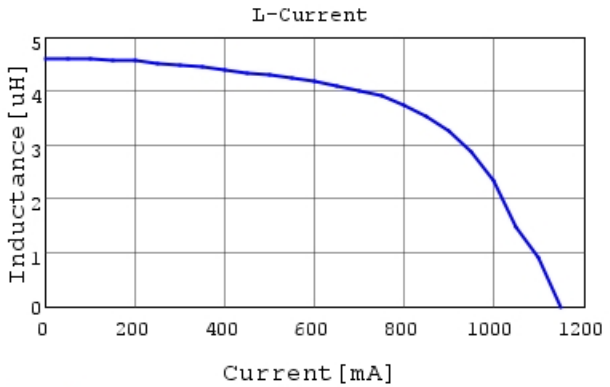

LQH2MPZ4R7MGR L-Current 20degC

Attention

- 1.This datasheet is downloaded from the website of Murata Manufacturing Co., Ltd. Therefore, it's specifications are subject to change or our products in it may be discontinued without advance notice. Please check with our sales representatives or product engineers before ordering.
- 2.This datasheet has only typical specifications because there is no space for detailed specifications.
Therefore, please review our product specifications or consult the approval sheet for product specifications before ordering.

LQH2MPZ4R7MGR#

“#” at the end indicates the package specification code.

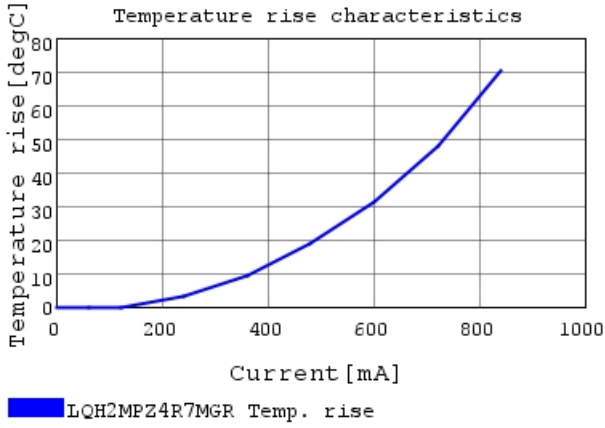

Attention

- 1.This datasheet is downloaded from the website of Murata Manufacturing Co., Ltd. Therefore, it's specifications are subject to change or our products in it may be discontinued without advance notice. Please check with our sales representatives or product engineers before ordering.
- 2.This datasheet has only typical specifications because there is no space for detailed specifications.
Therefore, please review our product specifications or consult the approval sheet for product specifications before ordering.