

N=Number of contacts

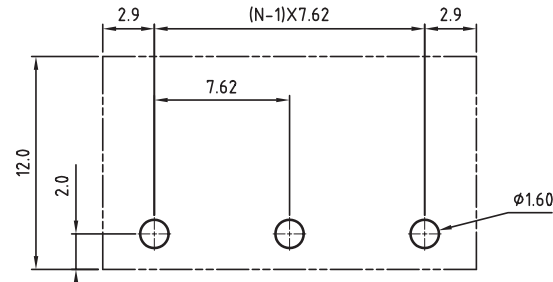
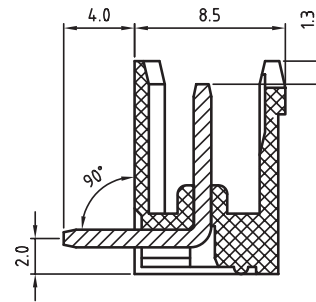

PCB LAYOUT - COMPONENT VIEW

TECHNICAL CHARACTERISTICS

MATERIAL
 INSULATOR: PBT
 FLAMABILITY RATING: UL94-V0
 COLOR: GREEN
 CONTACT: BRASS
 SOLDER TAIL PLATING: TIN

ENVIRONMENTAL
 OPERATING TEMPERATURE: -40 UP TO 105°C
 COMPLIANCE: LEAD FREE AND ROHS

ELECTRICAL
 CURRENT RATING: 20A
 WORKING VOLTAGE: 300VAC
 WITHSTANDING VOLTAGE: 1.6KV
 CONTACT RESISTANCE: 20 mOhm max

STANDARD
 eULus CERTIFIED E315414 / MODEL NUMBER 3124

MECHANICAL
 PITCH: 7.62MM

SOLDERING: WAVE PROCESS ONLY

PACKAGING: BOX

SERIE 3124

RoHS Compliant

PROJECTION:

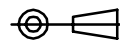

GENERAL TOLERANCE

.X = +/- 0.2

.XX = +/- 0.15



APPROVAL: RJ

UNIT: MM

SCALE:

SHEET: 1/1

DRAW: MARVIN

DESCRIPTION: SERIE 3124 - 7.62MM OPEN HORIZONTAL PCB HEADER
 WR-TBL

WERI PART NO: 691 312 410 0xx

SIZE

A4

Mouser Electronics

Authorized Distributor

Click to View Pricing, Inventory, Delivery & Lifecycle Information:

[Wurth Elektronik:](#)

[691312410012](#)