

PAN1770

Bluetooth® Low Energy Module

Product Specification

Rev. 1.0



Overview

The PAN1770 is a Bluetooth 5.1 Low Energy (LE) module based on the Nordic nRF52840 single chip controller.

Features

- Surface mount type dimensions: 15.6 mm x 8.7 mm x 2.05 mm
- Same form factor as PAN1026A and PAN1762 but smaller pitch and more pins
- U.FL connector for external antenna
- Nordic nRF52840 featuring ARM® Cortex®-M4F with 64 MHz
- Bluetooth 5.1 LE including LE 2M and LE Coded PHY
- Embedded 1 MB flash memory and 256 kB internal RAM
- Includes ARM TrustZone® CryptoCell™ 310 and supports secure boot including Root of Trust (RoT)
- Up to 48x General Purpose I/Os (GPIO), which are shared by up to 4x SPI, 2x I²C, 2x UART, 4x PWM, 8x ADC, NFC-A, 32 kHz IN/OUT, nRESET
- USB 2.0 full-speed device interface
- Built-in temperature sensor
- APPROTECT variant available

Bluetooth

- 2 Mbps high speed PHY, LE long range coded PHY
- LE advertising extensions (advertising on 40 channels total)
- Channel selection algorithm #2
- LE secure connections
- Over-the-air update of application software
- Qualified Bluetooth mesh profile stack

Characteristics

- Typical sensitivity: -95 dBm at 1 Mb/s and -103 dBm at 125 kb/s
- Typical max. output power: 8 dBm (configurable from -20 dBm in 4 dB steps and -40 dBm in whisper mode)
- Typical current consumption: 4.8 mA in Tx (at 0 dBm) and 4.8 mA in Rx mode
- Typical current consumption: 0.4 µA in System OFF mode, 1.5 µA with RTC wake up
- On-module DC-DC and LDO regulators with automated low current modes
- Voltage range: 1.7 V to 5.5 V
- Temperature range: -40 °C to 85 °C

Block Diagram

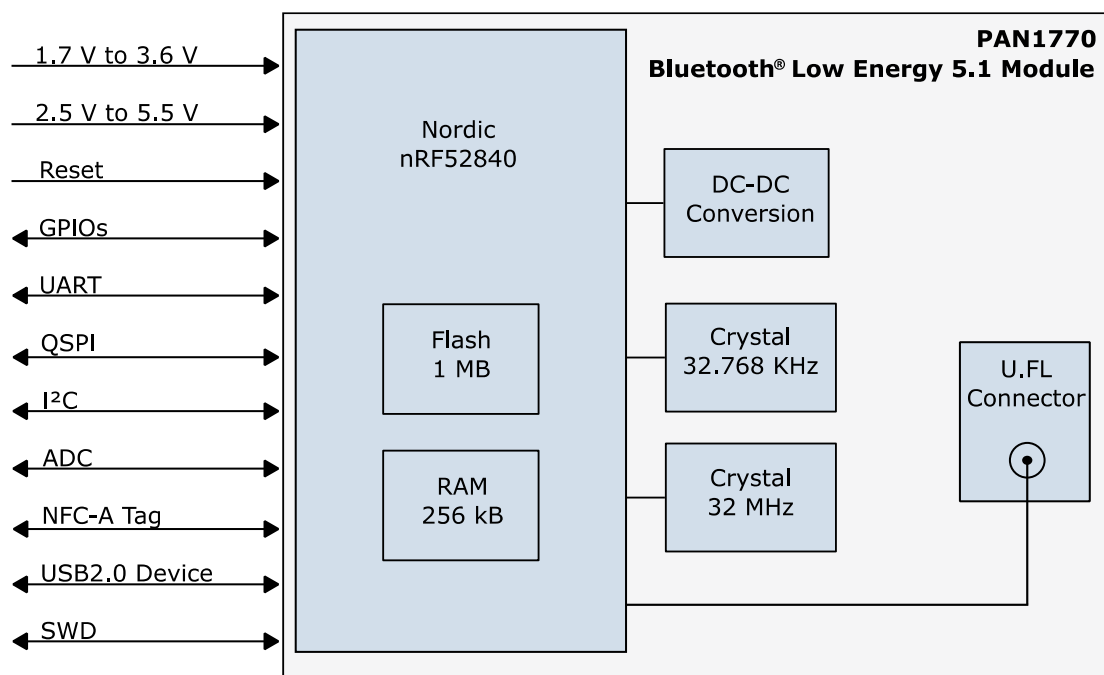

By purchase of any of the products described in this document the customer accepts the document's validity and declares their agreement and understanding of its contents and recommendations. Panasonic Industrial Devices Europe GmbH (Panasonic) reserves the right to make changes as required at any time without notification. Please consult the most recently issued Product Specification before initiating or completing a design.

© Panasonic Industrial Devices Europe GmbH 2022.

This specification sheet is copyrighted. Reproduction of this document is permissible only if reproduction is without alteration and is accompanied by all associated warranties, conditions, limitations, and notices. Do not disclose it to a third party.

All rights reserved.

This Product Specification does not lodge the claim to be complete and free of mistakes.

If this document is marked as preliminary, please be aware that its final content is not yet concluded and the use of it is at your own risk.

Document Acceptance

By signing the Product Specification, you acknowledge that you are a legal representative for your company and that you understand and accept the validity of the contents herein.

If the signed version of the Product Specification has not been returned to Panasonic within 30 days after receipt of the product, the specification or approval sheet shall be deemed to be accepted by you.

Engineering Samples (ES)

If Engineering Samples are delivered to the customer, these samples have the status "Engineering Samples". This means that the design of this product is not yet concluded. Engineering Samples may be partially or fully functional, and they may differ from the published Product Specification.

Engineering Samples are not qualified and they are not to be used for reliability testing or series production.

Disclaimer

The customer acknowledges that samples may deviate from the Product Specification and may bear defects due to their status of development and the lack of qualification mentioned above.

Panasonic rejects any liability or product warranty for Engineering Samples. In particular, Panasonic disclaims liability for damages caused by:

- The use of the Engineering Sample other than for evaluation purposes, particularly the installation or integration in another product to be sold by the customer,
- Deviation or lapse in function of the Engineering Sample,
- Improper use of the Engineering Sample.

Panasonic Industrial Devices Europe GmbH disclaims any liability for consequential and incidental damages. In case of any queries regarding the Engineering Samples, please contact your local sales partner or the related product manager.

Product Change Notifications (PCNs) and Information Notes (INs)

Please consider the following PCNs/INs and take suitable countermeasures where necessary and appropriate; for further details please contact your local Panasonic Sales office (⇒ [7.2.1 Contact Us](#)):

- Nordic APPROTECT vulnerability problem description: [IN133 Informational Notice v1.0](#)
- Nordic APPROTECT solution description: [IN141 Informational Notice v1.1](#)
- The vulnerability issue can be fixed by using the PAN1770 module with order number ENW89854C2KF and following the instructions on software given in Nordic APPROTECT solution description: [IN141 Informational Notice v1.1](#)

Information on Software

The PAN1770 module does not contain any software ex works, i.e. software is provided by 3rd party suppliers only. The essential software resources can be found on the partner website of Nordic Semiconductor <https://www.nordicsemi.com/>.

PIDEU provides a factory software programming service for your customized firmware; for further information please reach out to your local sales contact this regarding ⇒ [7.2.1 Contact Us](#).

Table of Contents

- 1 About This Document.....7**
 - 1.1 Purpose and Audience7
 - 1.2 Revision History.....7
 - 1.3 Use of Symbols7
 - 1.4 Related Documents8

- 2 Overview.....9**
 - 2.1 Block Diagram10
 - 2.2 Pin Configuration11
 - 2.3 Peripherals14
 - 2.4 Bluetooth Features14

- 3 Detailed Description15**
 - 3.1 Dimensions.....15
 - 3.2 Footprint16
 - 3.3 Packaging.....17
 - 3.4 Case Marking20

- 4 Specification21**
 - 4.1 Default Test Conditions21
 - 4.2 Absolute Maximum Ratings21
 - 4.3 Recommended Operating Conditions.....22
 - 4.4 Current Consumption.....22
 - 4.5 Bluetooth23
 - 4.6 Access Port Protection APPROTECT.....23
 - 4.7 Antenna Placement Recommendation25
 - 4.8 Reliability Tests25
 - 4.9 Recommended Soldering Profile26

- 5 Cautions27**
 - 5.1 Design Notes27
 - 5.2 Installation Notes27
 - 5.3 Usage Condition Notes.....28
 - 5.4 Storage Notes.....28
 - 5.5 Safety Cautions28
 - 5.6 Other Cautions29
 - 5.7 Restricted Use30

- 6 Regulatory and Certification Information31**
 - 6.1 General Certification Information31
 - 6.2 Federal Communications Commission (FCC) for US32
 - 6.3 Innovation, Science, and Economic Development (ISED) for Canada34
 - 6.4 European Conformity According to RED (2014/53/EU)38
 - 6.5 Bluetooth39
 - 6.6 RoHS and REACH Declaration39

- 7 Appendix40**
 - 7.1 Ordering Information.....40

7.2 Contact Details41

1 About This Document



1.1 Purpose and Audience

This Product Specification provides details on the functional, operational, and electrical characteristics of the Panasonic PAN1770 module. It is intended for hardware design, application, and Original Equipment Manufacturers (OEM) engineers. The product is referred to as “the PAN1770” or “the module” within this document.

1.2 Revision History

Revision	Date	Modifications/Remarks
1.0	2022-07-25	First version

1.3 Use of Symbols

Symbol	Description
	<p>Note</p> <p>Indicates important information for the proper use of the product. Non-observance can lead to errors.</p>
	<p>Attention</p> <p>Indicates important notes that, if not observed, can put the product’s functionality at risk.</p>
⇒ [chapter number] [chapter title]	<p>Cross reference</p> <p>Indicates cross references within the document.</p> <p>Example:</p> <p>Description of the symbols used in this document ⇒ 1.3 Use of Symbols.</p>
✓	<p>Requirement</p> <p>Indicates a requirement that must be met before the corresponding tasks can be completed.</p>
→	<p>Result</p> <p>Indicates the result of a task or the result of a series of tasks.</p>
This font	<p>GUI text</p> <p>Indicates fixed terms and text of the graphical user interface.</p> <p>Example:</p> <p>Click Save.</p>
Menu > Menu item	<p>Path</p> <p>Indicates a path, e.g. to access a dialog.</p> <p>Example:</p> <p>In the menu, select File > Setup page.</p>

Symbol	Description
This font	<p>Messages, user input, code</p> <p>Indicates messages, information, and code displayed on the screen or to be entered by the user.</p> <p>Examples:</p> <p>The message <code>Failed to save your data</code> is displayed.</p> <p>Enter the value <code>Product 123</code>.</p> <p>Copy firmware binaries to firmware library:</p> <pre>\$> cd \${TOP}/... \$> ...</pre>

1.4 Related Documents

For related documents please refer to the Panasonic website ⇒ [7.2.2 Product Information](#).

2 Overview

The PAN1770 is a Bluetooth 5.1 Low Energy (LE) module based on the Nordic nRF52840 single-chip controller.

The Bluetooth 5.1 features additionally a higher symbol rate of 2 Mbps using the high-speed LE 2M PHY or a significantly longer range using the LE coded PHY at 500 kb/s or 125 kb/s. The new channel selection algorithm (CSA#2) improves the performance in high interference environments. Furthermore, the new LE advertising extensions allow for much larger amounts of data to be broadcasted in connectionless scenarios.

An output power of up to 8 dBm and the high sensitivity of the nRF52840 in combination with the LE coded PHY make the module very attractive in applications, where a long range is required.

In addition, the ultra-low current consumption of the PAN1770 makes the module an ideal choice for battery powered devices.

With the Cortex-M4F processor, 256 kB RAM and the built-in 1 MB flash memory the PAN1770 can easily be used in standalone mode, thereby eliminating the need for an external processor, saving complexity, space, and cost.

The rich set of security features from the ARM TrustZone CryptoCell 310 security subsystem provides the necessary means for secure device operation in the IoT space.

The PAN1770 also supports Type 2 Near Field Communication (NFC-A) for use in simplified pairing and payment solutions (external antenna required).

For related documents please refer to [⇒ 7.2.2 Product Information](#).

For further information on the variants and versions please refer to [⇒ 7.1 Ordering Information](#).

2.1 Block Diagram

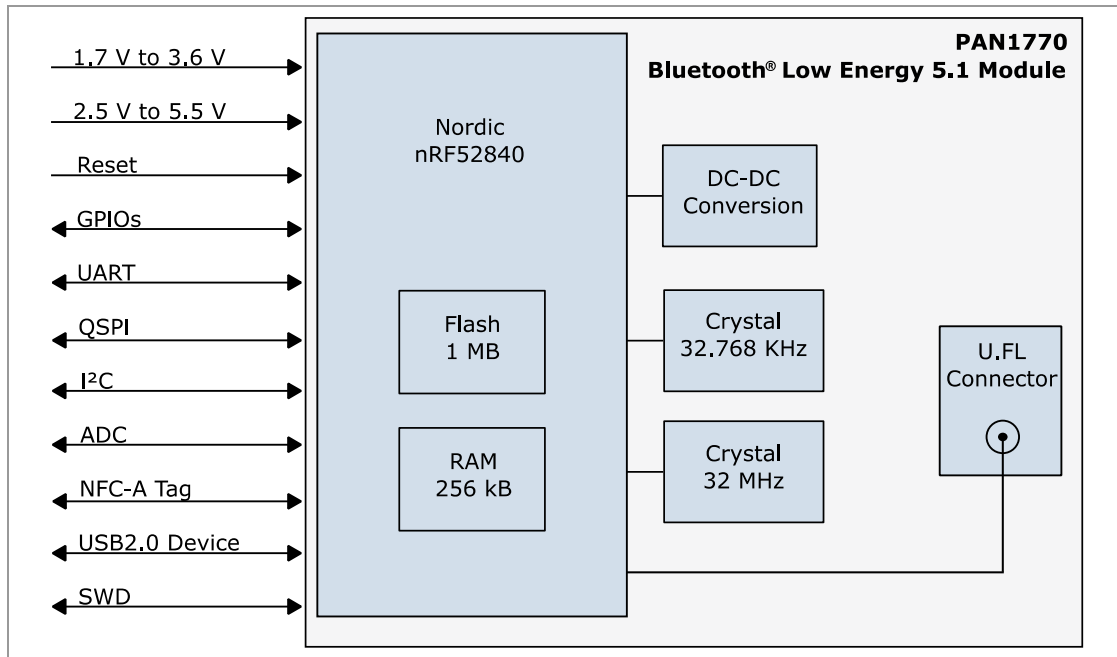

2.2 Pin Configuration

Pin Assignment

Top View

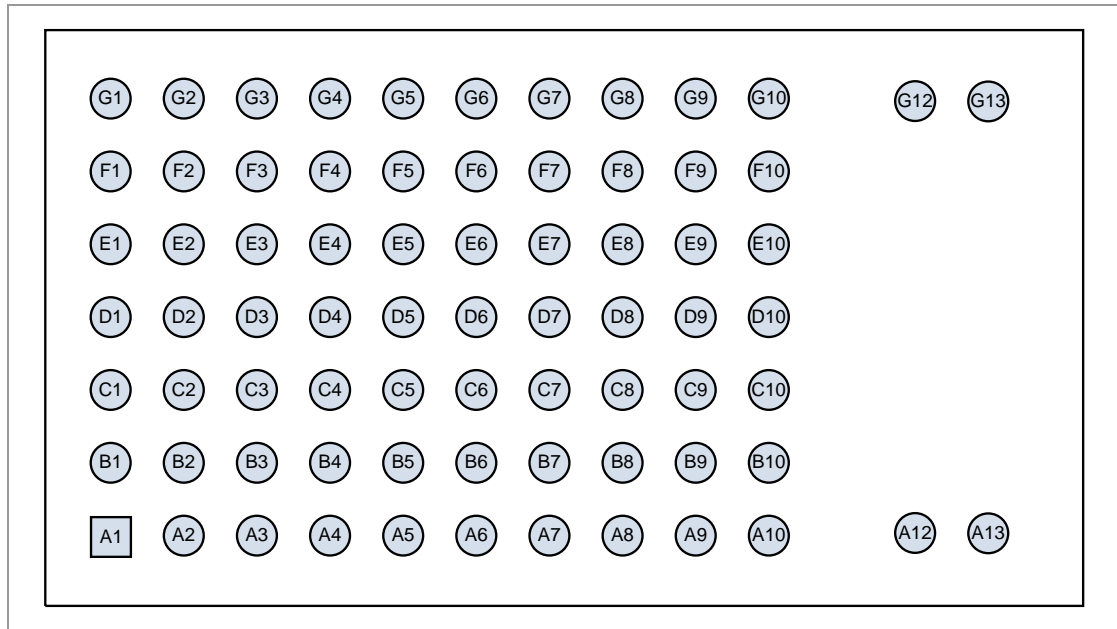

Pin Functions

No.	Pin Name	Pin Type	Description
A1	P0.27	Digital BI	GPIO
A2	P0.26	Digital BI	GPIO
A3	P0.04/AIN2	Digital BI/Analog Input	GPIO/Sensor to ADC
A4	P0.05/AIN3	Digital BI/Analog Input	GPIO/Sensor to ADC
A5	P0.03/AIN1	Digital BI/Analog Input	GPIO/Sensor to ADC
A6	P0.02/AIN0	Digital BI/Analog Input	GPIO/Sensor to ADC
A7	P0.29/AIN5	Digital BI/Analog Input	GPIO/Sensor to ADC
A8	NFC2	RF NFC BI	Connect to NFC Antenna
A9	NFC1	RF NFC BI	Connect to NFC Antenna
A10	GND	Ground	Connect to ground
A12	GND	Ground	Connect to ground
A13	GND	Ground	Connect to ground
B1	P0.06	Digital BI	GPIO
B2	X32k_OUT	32 kHz	Leave open
B3	P0.30/AIN6	Digital BI/Analog Input	GPIO/Sensor to ADC

No.	Pin Name	Pin Type	Description
B4	P0.31/AIN7	Digital BI/Analog Input	GPIO/Sensor to ADC
B5	P0.28/AIN4	Digital BI/Analog Input	GPIO/Sensor to ADC
B6	P1.13	Digital BI	GPIO
B7	P1.10	Digital BI	GPIO
B8	P1.06	Digital BI	GPIO
B9	P1.15	Digital BI	GPIO
B10	GND	Ground	Connect to ground
C1	P0.08	Digital BI	GPIO
C2	X32k_IN	32 kHz	Leave open
C3	P1.03	Digital BI	GPIO
C4	GND	Ground	Connect to ground
C5	GND	Ground	Connect to ground
C6	P1.14	Digital BI	GPIO
C7	P1.11	Digital BI	GPIO
C8	P1.12	Digital BI	GPIO
C9	P1.05	Digital BI	GPIO
C10	GND	Ground	Connect to ground
D1	GND	Ground	Connect to ground
D2	P1.08	Digital BI	GPIO
D3	P0.07/TRCCLK	Digital BI	GPIO or Trace IF Clock
D4	GND	Ground	Connect to ground
D5	GND	Ground	Connect to ground
D6	P0.24	Digital BI	GPIO
D7	P1.02	Digital BI	GPIO
D8	P1.07	Digital BI	GPIO
D9	GND	Ground	Connect to ground
D10	GND	Ground	Connect to ground
E1	LV Mode	Supply Voltage	1.7 V to 3.6 V
E2	P1.09/TRCDAT3	Digital BI	GPIO or Trace IF D3
E3	GND	Ground	Connect to ground
E4	P0.17	Digital BI	GPIO
E5	P0.23	Digital BI	GPIO
E6	P0.20	Digital BI	GPIO

No.	Pin Name	Pin Type	Description
E7	P0.21	Digital BI	GPIO
E8	SWDCLK	Digital BI	Serial Wire Debug IF Clock
E9	P1.04	Digital BI	GPIO
E10	NC		Leave open
F1	P0.12/TRCDAT1	Digital BI	GPIO or Trace IF D1
F2	P0.11/TRCDAT2	Digital BI	GPIO or Trace IF D2
F3	P0.13	Digital BI	GPIO
F4	P0.14	Digital BI	GPIO
F5	P0.15	Digital BI	GPIO
F6	P0.19	Digital BI	GPIO
F7	P1.01	Digital BI	GPIO
F8	P0.25	Digital BI	GPIO
F9	P0.22	Digital BI	GPIO
F10	GND	Ground	Connect to ground
G1	P0.16	Digital BI	GPIO
G2	HV Mode	Supply Voltage	2.5 V to 5.5 V (optional)
G3	GND	Ground	Connect to ground
G4	USB Mode	Supply Voltage	4.35 V to 5.5 V
G5	DP	USB D+	Use for USB only
G6	DM	USB D-	Use for USB only
G7	nRESET	Digital I	Reset Signal Low Active
G8	P1.00/TRCDAT0	Digital BI	GPIO or Trace IF D0
G9	SWDIO	Digital BI	Serial Wire Debug IF Data
G10	GND	Ground	Connect to ground
G12	GND	Ground	Connect to ground
G13	GND	Ground	Connect to ground

2.3 Peripherals

- Full-speed USB 2.0 device controller
- 2x UART (2x or 4x wire with CTS/RTS, 1 200 up to 1 M baud)
- I²C, I²S, SPI (32 MHz)
- QSPI (32 MHz)
- PWM
- PDM
- AES and CryptoCell
- 8x channel 12 bit ADC
- Comparator
- Quadrature decoder
- Temperature sensor
- Real time counter
- Watchdog timer
- 48x PIOs
- Integrated 32 kHz crystal

2.4 Bluetooth Features

- Bluetooth LE 5.1
- Supports Bluetooth LE 5.1 high speed and long range modes

3 Detailed Description

3.1 Dimensions



All dimensions are in millimeters.

Top View

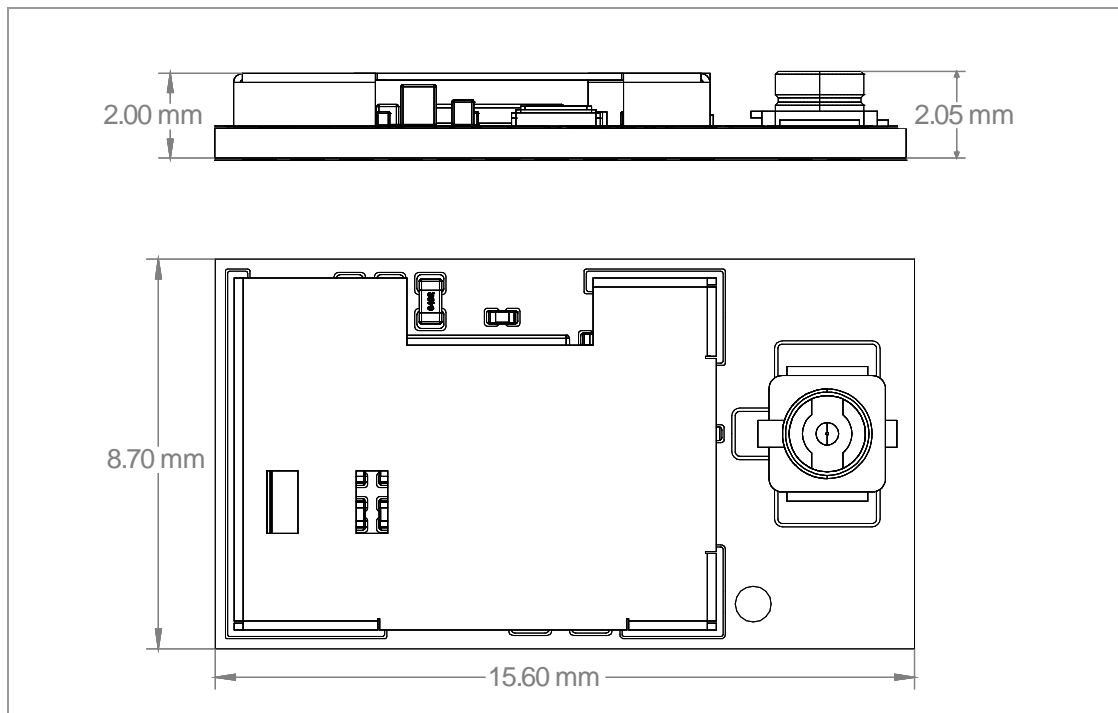

No.	Item	Dimension	Tolerance	Remark
1	Width	8.70	±0.30	
2	Length	15.60	±0.30	
3	Height	2.05	±0.30	With U.FL connector

3.2 Footprint



All dimensions are in millimeters.

Top View

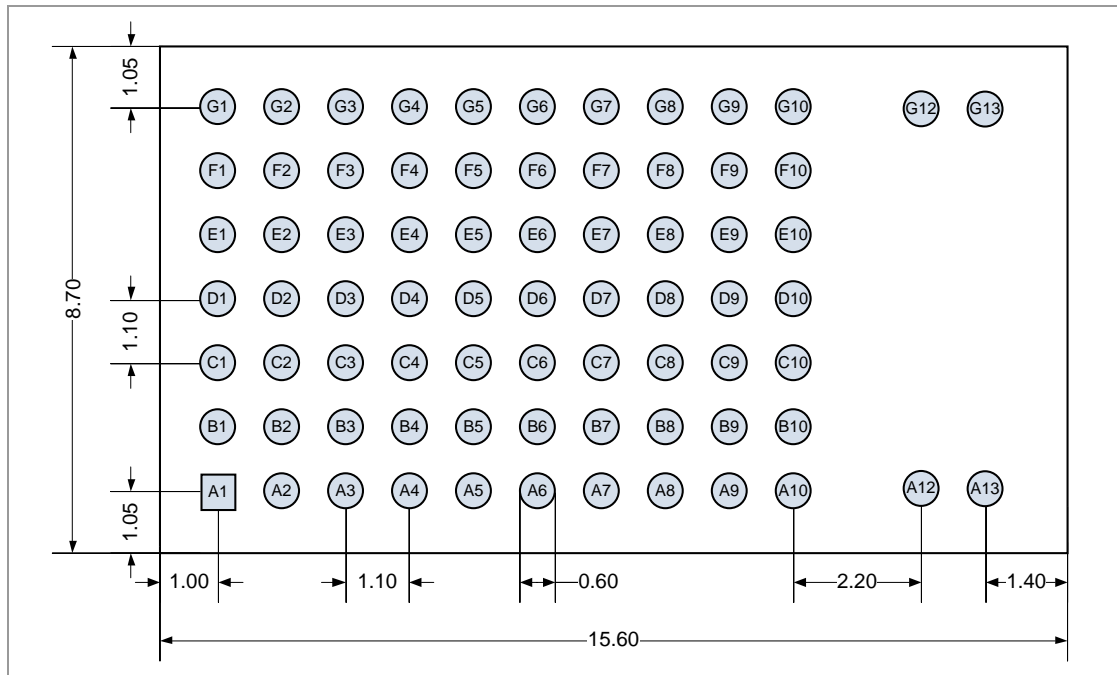

3.3 Packaging

The module is a mass production status product and will be delivered in the package described below.

3.3.1 Tape Dimensions

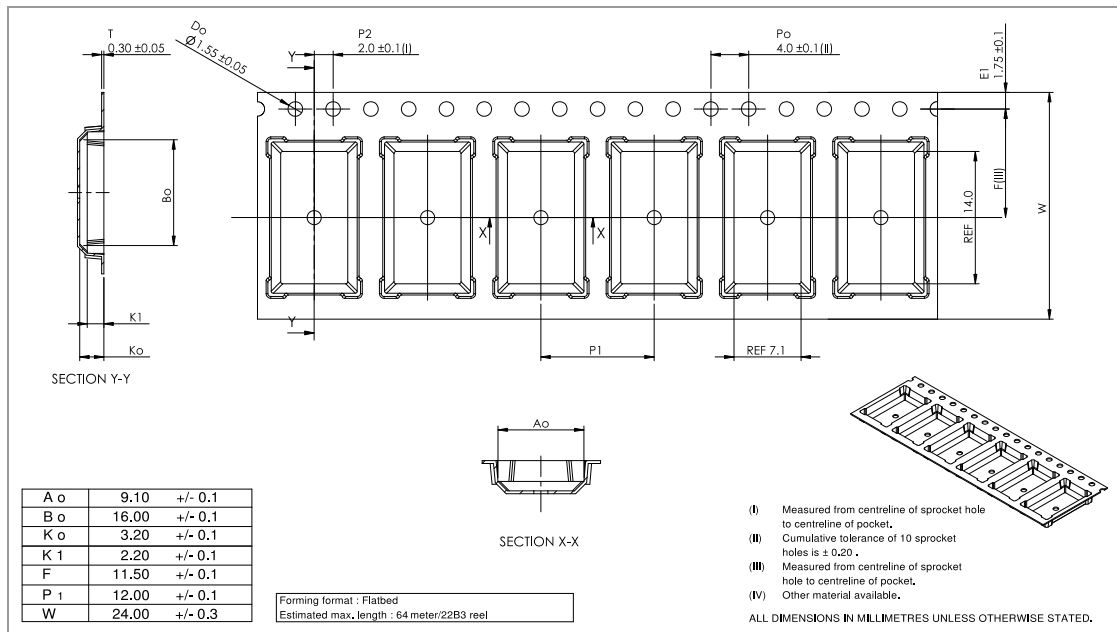

3.3.2 Packing in Tape

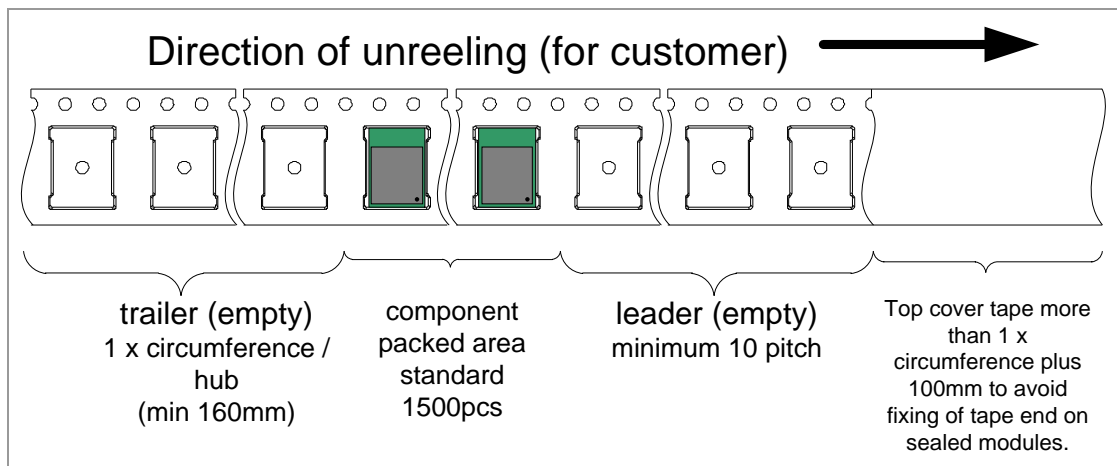

Empty spaces in the component packed area shall be less than two per reel and those spaces shall not be consecutive.

The top cover tape shall not be found on reel holes and it shall not stick out from the reel.

3.3.3 Component Direction

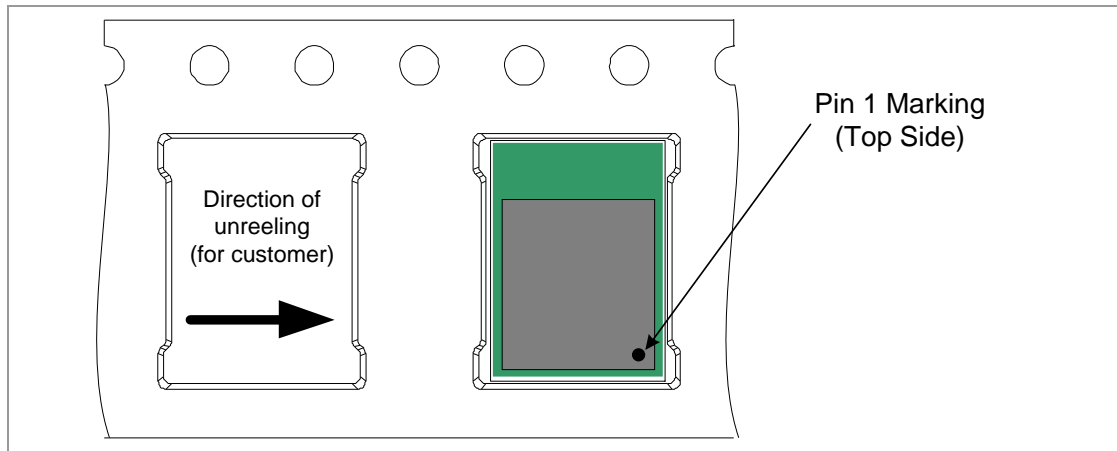

3.3.4 Reel Dimension

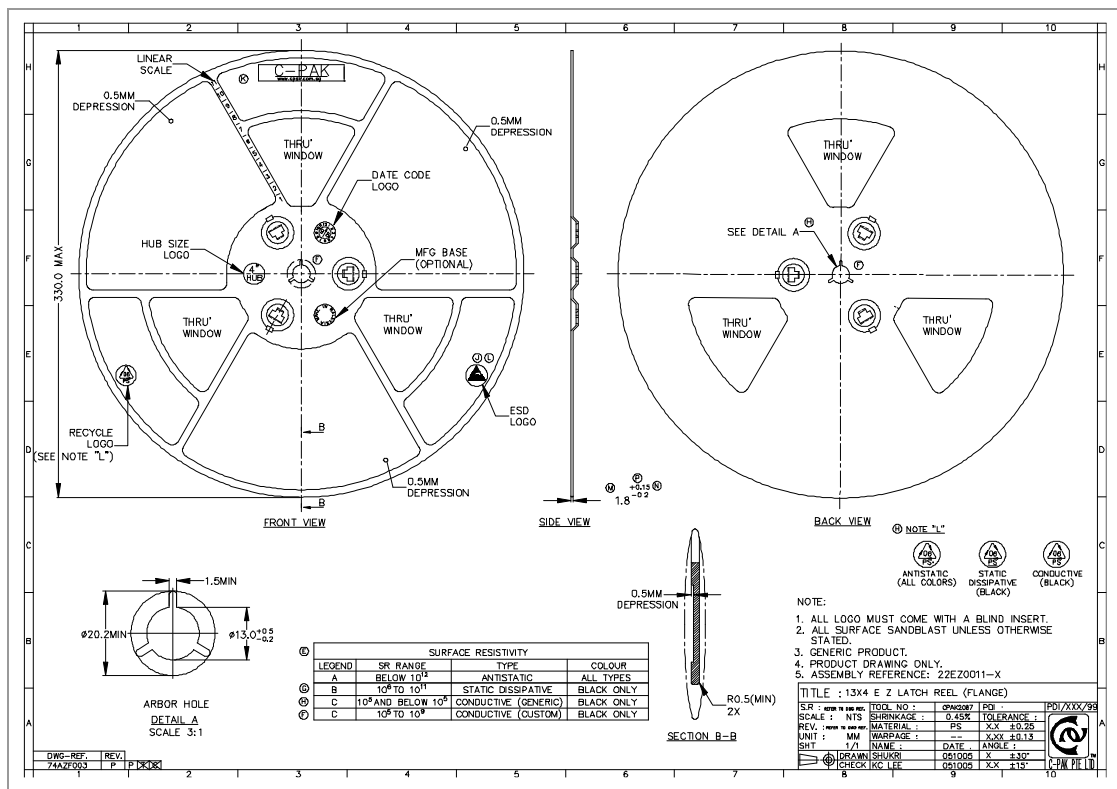

3.3.5 Package Label

Example:

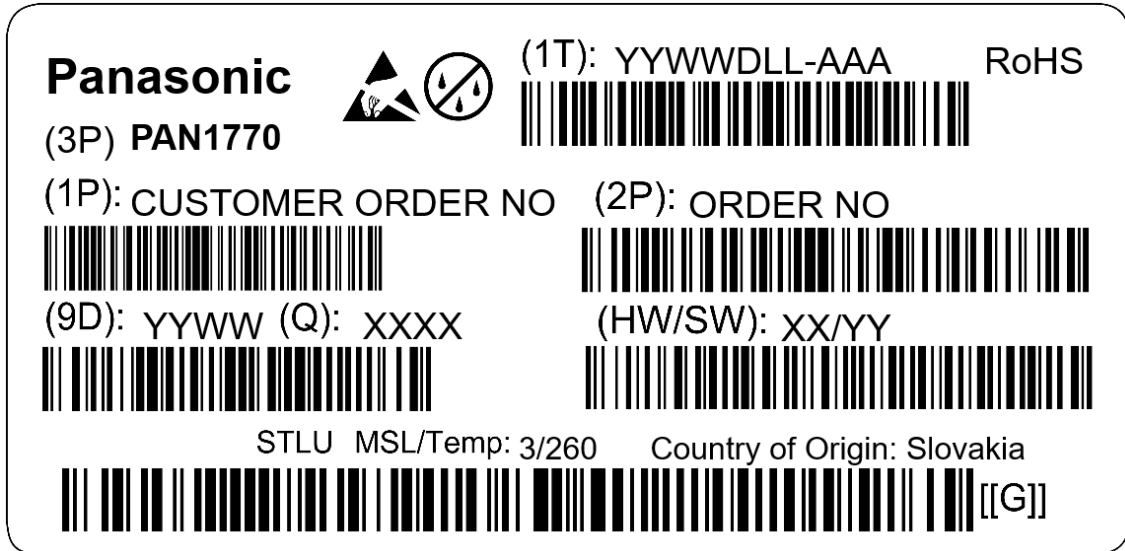

(1T)	Lot code
(1P)	Customer order number, if applicable
(2P)	Order number
(9D)	Date code
(Q)	Quantity
(HW/SW)	Hardware/software version

3.3.6 Total Package

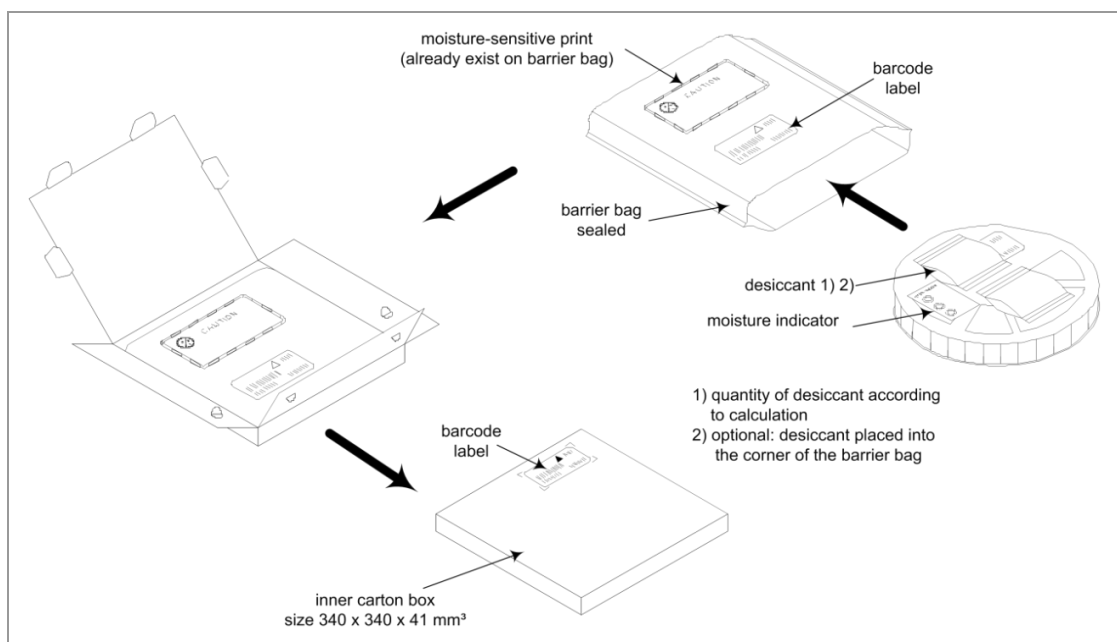

3.4 Case Marking

Example:

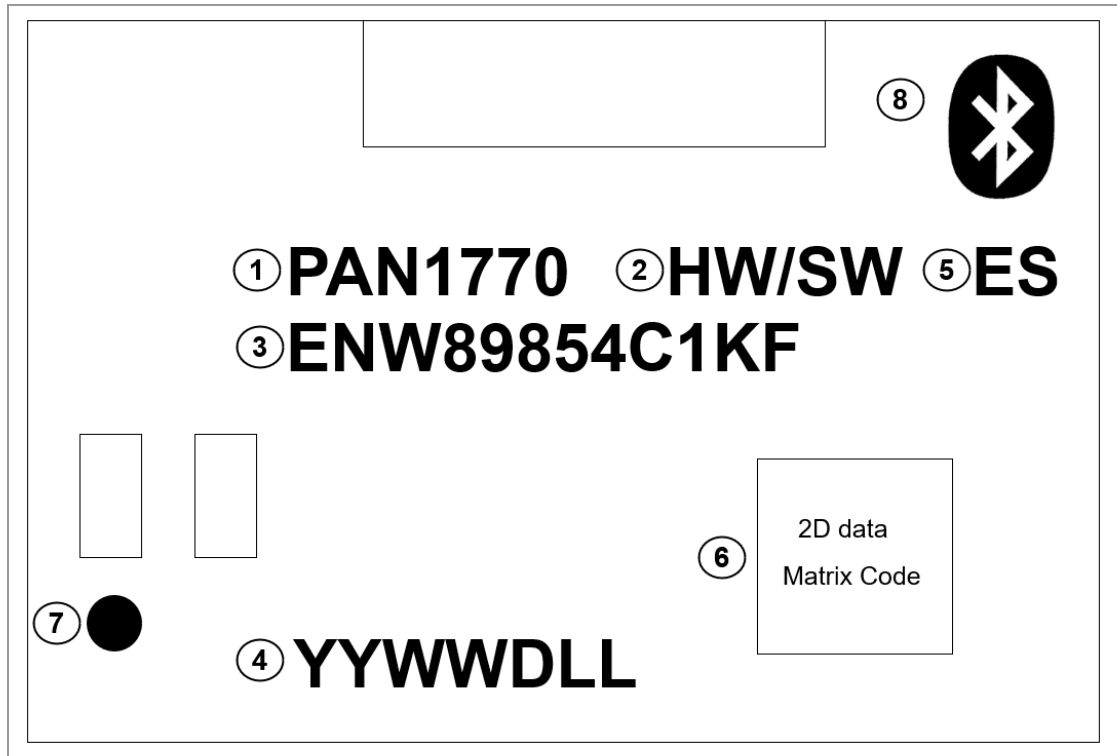

- 1 Brand name
- 2 Hardware/software version
- 3 Order number
- 4 Lot code
- 5 Status: ES or empty for MP
- 6 2D barcode, for internal usage only
- 7 Marking for Pin 1
- 8 Bluetooth logo

4 Specification



All specifications are over temperature and process, unless indicated otherwise.

4.1 Default Test Conditions



Temperature: 25 °C ± 10 °C
Humidity: 40 % to 85 % RH
Supply Voltage: 3.3 V

4.2 Absolute Maximum Ratings



The maximum ratings may not be exceeded under any circumstances, not even momentarily or individually, as permanent damage to the module may result.

Symbol	Parameter	Condition	Min.	Typ.	Max.	Unit
V _{DD}	Normal Supply Voltage		-0.3		+3.9	V
V _{DDH}	High Supply Voltage		-0.3		+5.8	
V _{BUS}	USB Bus Voltage		-0.3		+5.8	
I/O Pin	Voltage on any Pin	V _{DD} ≤ 3.6 V	-0.3		V _{DD} + 0.3	
		V _{DD} > 3.6 V	-0.3		3.9	
ESD	ESD Robustness	HBM 1C			1 000	
		CDM			500	
MSL	Moisture Sensitivity Level				1	
P _{RF}	RF Input Level				+10	dBm
T _{STOR}	Storage Temperature		-40		+125	°C

4.3 Recommended Operating Conditions



The maximum ratings may not be exceeded under any circumstances, not even momentarily or individually, as permanent damage to the module may result.

Symbol	Parameter	Condition	Min.	Typ.	Max.	Unit
V _{DD} (LV Mode)	Supply Voltage		1.7		3.6	V
t _{R_VDD}	Supply Rise Time	0 V to 1.7 V			60	ms
V _{DD-POR}	Supply Voltage	Power On Reset active	1.75			V
V _{DDH} (HV Mode)	Supply Voltage	V _{DDH} - Optional	2.5		5.5	V
t _{R_VDDH}	Supply Rise Time	0 V to 3.7 V			100	ms
V _{BUS}	VBUS USB Supply Voltage	V _{BUS} - Optional	4.35		5.5	V
V _{I/O}	Max I/O Pin Voltage	V _{DD} ≤ 3.6 V	-0.3		V _{DD} + 0.3	V
		V _{DD} ≥ 3.6 V			3.9	
TA	Operating Temperature		-40	25	85	°C

4.4 Current Consumption



The current consumption depends on the user scenario and on the setup and timing in the power modes.

Assume V_{DD} = 3.3 V, T_{amb} = 25 °C, if nothing else stated, DC-DC enabled.

Parameter	Condition	Min.	Typ.	Max.	Unit
Sleep Mode	No RAM retention, Wake on Reset, SYS OFF		0.4		μA
	Full RAM retention, Wake on Reset, SYS OFF		1.86		μA
	No RAM retention, Wake on any event, SYS ON		0.97		μA
	Full RAM retention, Wake on any event, SYS ON		2.35		μA
	No RAM retention, Wake on RTC, SYS ON		1.5		μA
CPU executing CoreMark	Running from RAM		2.8		mA
	Running from Flash		3.3		mA
Rx Current			4.8		mA

Parameter	Condition	Min.	Typ.	Max.	Unit
Tx Current	8 dBm		14.8		mA
	4 dBm		9.6		mA
	0 dBm		4.8		mA
	-4 dBm		3.1		mA
	-8 dBm		3.3		mA
	-12 dBm		3.0		mA
	-16 dBm		3.8		mA
	-20 dBm		2.7		mA
	-40 dBm		2.3		mA

4.5 Bluetooth

Parameter	Specification
Frequency	2 402 MHz to 2 480 MHz
Data Rate	2 Mbps, 1 Mbps, 500 kbps, 125 kbps
Number of Channels	40: 37 data/3 advertising (0, 12, 39)
Receive Sensitivity	-103 dBm (125 kbps Bluetooth LE mode), -95 dBm (1 Mbps Bluetooth LE mode), -92 (2 Mbps Bluetooth LE mode)
Output Power	-40 dBm to +8 dBm
Link Budget	Up to 111 dB

4.6 Access Port Protection APPROTECT

If using the APPROTECT version of the PAN1770 with order number ENW89854C2KF a special sequence of commands is necessary during production programming. These commands ensure that the built-in Bluetooth Device Address is preserved when the access port protection is enabled.

The access port protection prevents (amongst others) any access to the built-in flash memory through the device debug port.

In factory state, the PAN1770 with order number ENW89854C2KF implementing Nordic nRF52840 “revision 3 silicon” comes with the access port protection disabled.

Locking the Device Debug Port and enabling the Access Port Protection



Once the access port protection is enabled, no further access including debugging can be done anymore!



Please make sure to use the described (or later) software version.

To ensure that the device debug port is locked during production programming and the access port protection is enabled correctly, the following steps must be followed.

1. Use the Microcontroller Development Kit (MDK) [nRF MDK \(version 8.40.2\)](#) for application development.
 - If the application is based on [nRF5 SDK \(version 17.1.0\)](#), compile the application with the globally defined `ENABLE_APPROTECT-define`.
Open the project in **Segger Embedded Studio**. Set the define in **Project options** > Section **Code** > **Preprocessor Options** > **Preprocessor Definitions**.
 - If the application is based on [nRF Connect SDK \(version 1.8.0\)](#), compile the application with the `CONFIG_NRF_APPROTECT_LOCK=y` option set, for example in the project configuration file `prj.conf`.

2. Use the [nRF Command Line Tools \(version 10.15.2\)](#) for production programming.

3. Execute `nrfjprog.exe --verify fast --sectorerase --program application.hex` from a command line prompt to program an application HEX file:

```
Parsing image file.
Verifying programming.
Verified OK.
```

4. Execute `nrfjprog.exe --rbp ALL` from a command line prompt to enable the access port protection:

```
Protected the device against read and debug. Only a
--recover, --debugreset, or --pinreset operations will work from
now on.
```



It is possible to disable the access port protection again using the option `--recover`, but the complete PAN1770 module is erased including the built-in Bluetooth Device Address.

For details how to prevent this during application development, please refer to the “PAN1770 EVB User Guide (“Bluetooth Address Safeguard”)”.

For technical details please refer to [IN141 Informational Notice v1.1](https://infocenter.nordicsemi.com/) in the Nordic Infocenter <https://infocenter.nordicsemi.com/>.

4.7 Antenna Placement Recommendation



Impact of Placement on the Antenna Radiation Pattern

The placement of the antenna, surrounding material, and customer components has an impact on his radiation pattern.



It is recommended to use the antenna and “U.FL to Reverse Polarity SMA” adapter cable listed in ⇒ [6.2.5 Approved Antenna List](#).

The following requirements must be met:

- ✓ Keep this product away from heat. Heat is the major cause of decreasing the life of these products.
- ✓ Keep this product away from other high frequency circuits.

4.8 Reliability Tests

The measurement should be done after the test module has been exposed to room temperature and humidity for one hour.

No.	Item	Limit	Condition
1	Variable Vibration Test	Electrical parameters should be within specification	Freq.: 20~2 000 Hz, Acc.: 17-50 G, Sweep: 8 min, 2 hours, For: XYZ axis
2	Shock Drop Test		Drop parts on concrete from a height of 1 m for 3 times
3	Heat-Shock/ Temperature Cycling Test		At -40 °C and 85 °C for 1 h/cycle Total = 300 cycles
4	Temperature Humidity Bias Test		At 60 °C, 85 % r.H., 300 h
5	Low Temperature Storage Life Test		At -40 °C, 300 h
6	High Temperature Storage Life Test		At 85 °C, 300 h

4.9 Recommended Soldering Profile



- Reflow permissible cycles: 2
- Opposite side reflow is prohibited due to module weight
- More than 75 percent of the soldering area shall be coated by solder
- The soldering profiles should be adhered to in order to prevent electrical or mechanical damage
- Soldering profile assumes lead-free soldering

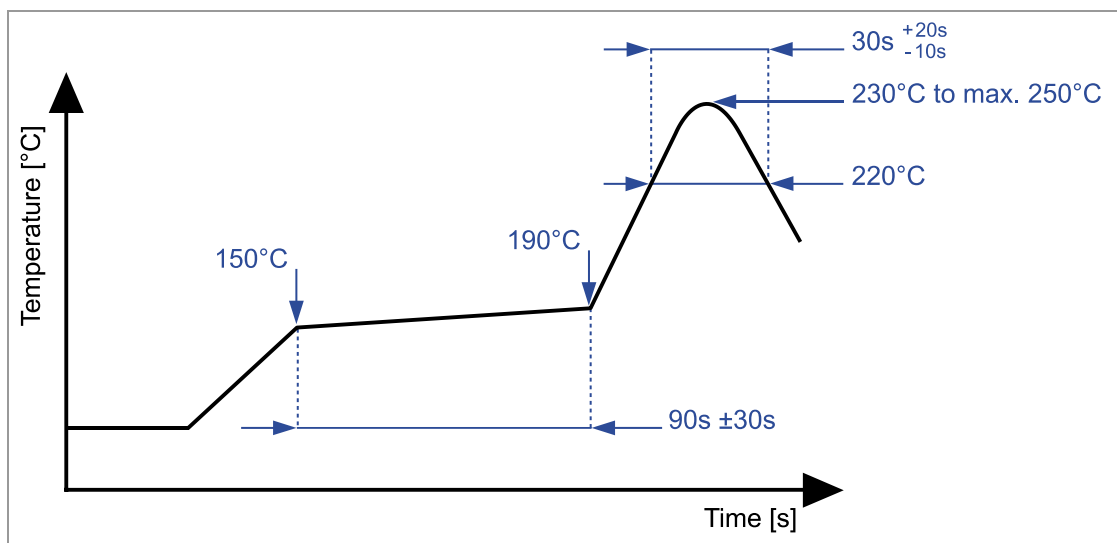

5 Cautions



Failure to follow the guidelines set forth in this document may result in degrading of the module functions and damage to the module.

5.1 Design Notes

1. Follow the conditions written in this specification, especially the control signals of this module.
2. The supply voltage should abide by the maximum ratings (⇒ [4.2 Absolute Maximum Ratings](#)).
3. The supply voltage must be free of AC ripple voltage (for example from a battery or a low noise regulator output). For noisy supply voltages, provide a decoupling circuit (for example a ferrite in series connection and a bypass capacitor to ground of at least 47 μ F directly at the module).
4. This module should not be mechanically stressed when installed.
5. Keep this module away from heat. Heat is the major cause of decreasing the life time of these modules.
6. Avoid assembly and use of the target equipment in conditions where the module temperature may exceed the maximum tolerance.
7. Keep this module away from other high frequency circuits.
8. Refer to the recommended pattern when designing a board.

5.2 Installation Notes

1. Reflow soldering is possible twice based on the conditions set forth in ⇒ [4.9 Recommended Soldering Profile](#). Set up the temperature at the soldering portion of this module according to this reflow profile.
2. Carefully position the module so that the heat will not burn into printed circuit boards or affect other components that are susceptible to heat.
3. Carefully locate the module, to avoid an increased temperature caused by heat generated by neighboring components.
4. If a vinyl-covered wire comes into contact with the module, the wire cover will melt and generate toxic gas, damaging the insulation. Never allow contact between a vinyl cover and these modules to occur.
5. This module should not be mechanically stressed or vibrated when reflowed.
6. To repair the board by hand soldering, follow the conditions set forth in this chapter.
7. Do not wash this product.
8. Pressing on parts of the metal cover or fastening objects to the metal will cause damage to the module.

5.3 Usage Condition Notes

1. Take measures to protect the module against static electricity.
If pulses or transient loads (a large load, which is suddenly applied) are applied to the modules, check and evaluate their operation before assembly of the final products.
2. Do not use dropped modules.
3. Do not touch, damage, or soil the pins.
4. Follow the recommended condition ratings about the power supply applied to this module.
5. Electrode peeling strength: Do not apply a force of more than 4.9 N in any direction on the soldered module.
6. Pressing on parts of the metal cover or fastening objects to the metal cover will cause damage.
7. These modules are intended for general purpose and standard use in general electronic equipment, such as home appliances, office equipment, information, and communication equipment.

5.4 Storage Notes

1. The module should not be stressed mechanically during storage.
2. Do not store these modules in the following conditions or the performance characteristics of the module, such as RF performance will be adversely affected:
 - Storage in salty air or in an environment with a high concentration of corrosive gas, such as Cl₂, H₂S, NH₃, SO₂, or NO_x,
 - Storage in direct sunlight,
 - Storage in an environment where the temperature may be outside the range of 5 °C to 35 °C, or where the humidity may be outside the 45 % to 85 % range,
 - Storage of the modules for more than one year after the date of delivery storage period: Please check the adhesive strength of the embossed tape and soldering after 6 months of storage.
3. Keep this module away from water, poisonous gas, and corrosive gas.
4. This module should not be stressed or shocked when transported.
5. Follow the specification when stacking packed crates (max. 10).

5.5 Safety Cautions

These specifications are intended to preserve the quality assurance of products and individual components.

Before use, check and evaluate the operation when mounted on your products. Abide by these specifications without deviation when using the products. These products may short-circuit. If electrical shocks, smoke, fire, and/or accidents involving human life are anticipated when a short circuit occurs, provide the following failsafe functions as a minimum:

1. Ensure the safety of the whole system by installing a protection circuit and a protection device.
2. Ensure the safety of the whole system by installing a redundant circuit or another system to prevent a single fault causing an unsafe status.

5.6 Other Cautions

1. Do not use the module for other purposes than those listed in [⇒ 5.3 Usage Condition Notes](#).
2. Be sure to provide an appropriate fail-safe function on your product to prevent any additional damage that may be caused by the abnormal function or the failure of the module.
3. This module has been manufactured without any ozone chemical controlled under the Montreal Protocol.
4. These modules are not intended for use under the special conditions shown below. Before using these modules under such special conditions, carefully check their performance and reliability under the said special conditions to determine whether or not they can be used in such a manner:
 - In liquid, such as water, salt water, oil, alkali, or organic solvent, or in places where liquid may splash,
 - In direct sunlight, outdoors, or in a dusty environment,
 - In an environment where condensation occurs,
 - In an environment with a high concentration of harmful gas (e. g. salty air, HCl, Cl₂, SO₂, H₂S, NH₃, and NO_x).
5. If an abnormal voltage is applied due to a problem occurring in other components or circuits, replace these modules with new modules, because they may not be able to provide normal performance even if their electronic characteristics and appearances appear satisfactory.



For further information please refer to the Panasonic website [⇒ 7.2.2 Product Information](#).

5.7 Restricted Use

5.7.1 Life Support Policy

This Panasonic Industrial Devices Europe GmbH product is not designed for use in life support appliances, devices, or systems where malfunction can reasonably be expected to result in a significant personal injury to the user, or as a critical component in any life support device or system whose failure to perform can be reasonably expected to cause the failure of the life support device or system, or to affect its safety or effectiveness.

Panasonic customers using or selling these products for use in such applications do so at their own risk and agree to fully indemnify Panasonic Industrial Devices Europe GmbH for any damages resulting.

5.7.2 Restricted End Use

This Panasonic Industrial Devices Europe GmbH product is not designed for any restricted activity that supports the development, production, handling usage, maintenance, storage, inventory or proliferation of any weapons or military use.

Transfer, export, re-export, usage or reselling of this product to any destination, end user or any end use prohibited by the European Union, United States or any other applicable law is strictly prohibited.

6 Regulatory and Certification Information

6.1 General Certification Information



Regulatory certifications are valid for the following radio relevant software:

- Nordic SoftDevice S140, S113, and Wirepas V4.x or V5.x
- Bluetooth Specification 5.1



Regulatory certifications stay valid for APPROTECT versions provided that:

If the nRF52840 new silicon revision 3 with access port protection, which is implemented in the PAN1770 with Panasonic order number ENW89854C2KF is used:

- [Nordic IN141 Informational Notice v1.1](#) states “The new revision has no impact on CE, FCC/ISED or Bluetooth certifications unless the new pulse shaping filter is enabled.”
- [Nordic FTPAN-254](#) describes how to enable the pulse shaping filter, but as stated before it needs to remain disabled. Hence the code described in [Nordic FTPAN-254](#) shall not be implemented/executed; otherwise the PAN1770 pre-certification becomes invalid. The [Nordic FTPAN-254](#) workaround is meant for designs using an PA/LNA RF front end, which is not feasible with the PAN1770. Therefore, it is not useful to implement [Nordic FTPAN-254](#).



For further certification requests for other radio software please contact Panasonic ⇒ [7.2 Contact Details](#).

6.2 Federal Communications Commission (FCC) for US

6.2.1 FCC Notice



The PAN1770 including the antennas, which are listed in ⇒ [6.2.5 Approved Antenna List](#), complies with Part 15 of the FCC Rules.

The device meets the requirements for modular transmitter approval as detailed in FCC public Notice DA00-1407. The transmitter operation is subject to the following two conditions:

1. This device may not cause harmful interference, and
2. This device must accept any interference received, including interference that may cause undesired operation.

6.2.2 Caution



The FCC requires the user to be notified that any changes or modifications made to this device that are not expressly approved by Panasonic Industrial Devices Europe GmbH may void the user's authority to operate the equipment.



This equipment has been tested and found to comply with the limits for a Class B digital device, pursuant to Part 15 of the FCC Rules.

These limits are designed to provide reasonable protection against harmful interference in a residential installation. This equipment generates uses and can radiate radio frequency energy and, if not installed and used in accordance with the instructions, may cause harmful interference to radio communications.

There is no guarantee that interference will not occur in a particular installation. If this equipment does cause harmful interference to radio or television reception, which can be determined by turning the equipment off and on, the user is encouraged to try to correct the interference by one or more of the following measures:

- Reorient or relocate the receiving antenna,
- Increase the separation between the equipment and receiver,
- Connect the equipment into an outlet on a circuit different from that to which the receiver is connected,
- Consult the dealer or an experienced radio/TV technician for help.

6.2.3 Label Requirements



The OEM must ensure that FCC labelling requirements are met. This includes a clearly visible label on the outside of the OEM enclosure specifying the appropriate Panasonic FCC identifier for this product as well as the FCC Notice above.

The FCC identifier is **FCC ID: T7V1780**.

This FCC identifier is valid for the PAN1770. The end product must in any case be labelled on the exterior with:

"Contains FCC ID: T7V1780".

Due to the PAN1770 model size, the FCC identifier is displayed in the installation instruction only and it cannot be displayed readable on the module's label due to the limited size.

6.2.4 Antenna Warning

This antenna warning refers to the test device with the model number PAN1770 ⇒ [7.1 Ordering Information](#).

The device is tested with a "U.FL to Reverse Polarity SMA" adapter cable and with the antenna listed in ⇒ [6.2.5 Approved Antenna List](#). When integrated into the OEM's product, these antennas require installation preventing end users from replacing them with non-approved antennas. Any antenna not in the following table must be tested to comply with FCC Section 15.203 for unique antenna connectors and with Section 15.247 for emissions. The FCC identifier for the device with the antenna listed in ⇒ [6.2.5 Approved Antenna List](#) is the same (**FCC ID: T7V1780**).

6.2.5 Approved Antenna List

Item	Part Number	Manufacturer	Frequency Band (GHz)	Type	Max. Gain (dBi)
1	W1030 2016693-x	Pulse TE Connectivity	2.4	Dipole antenna assembly	+1.4

6.2.6 RF Exposure



To comply with FCC RF Exposure requirements, the OEM must ensure that only antennas from the Approved Antenna List are installed ⇒ [6.2.5 Approved Antenna List](#).

The preceding statement must be included as a “CAUTION” statement in manuals for products operating with the approved antennas in the previous table to alert users on FCC RF Exposure compliance.

Any notification to the end user of installation or removal instructions about the integrated radio module is not allowed.

The radiated output power of the PAN1770 with a mounted ceramic antenna (**FCC ID: T7V1780**) is below the FCC radio frequency exposure limits. Nevertheless, the PAN1770 shall be used in such a manner that the potential for human contact during normal operation is minimized.

End users may not be provided with the module installation instructions. OEM integrators and end users must be provided with transmitter operating conditions for satisfying RF exposure compliance.

6.3 Innovation, Science, and Economic Development (ISED) for Canada

English

The PAN1770 is licensed to meet the regulatory requirements of ISED.

License ID: **IC: 216Q-1780**

HVIN: **ENW89854C1KF, ENW89854C2KF**

Manufacturers of mobile, fixed or portable devices incorporating this module are advised to clarify any regulatory questions and ensure compliance for SAR and/or RF exposure limits. Users can obtain Canadian information on RF exposure and compliance from www.ic.gc.ca.

This device has been designed to operate with the antennas listed in ⇒ [6.2.5 Approved Antenna List](#), having a maximum gain of +1.4 dBi. Antennas not included in this list or having a gain greater than +1.4 dBi are strictly prohibited for use with this device. The required antenna impedance is 50 Ω. The antenna used for this transmitter must not be co-located or operating in conjunction with any other antenna or transmitter.

Due to the model size, the IC identifier is displayed in the installation instruction only and it cannot be displayed on the module's label due to the limited size.



The end customer has to assure that the device has a distance of more than 15 mm from the human body under all circumstances.

If the end customer application intends to use the PAN1770 in a distance smaller 15 mm from the human body, SAR evaluation has to be repeated by the OEM.

The end customer equipment must meet the actual Safety/Health requirements according to ISED.

French

PAN1770 est garanti conforme aux dispositions réglementaires d'Industry Canada (ISED).

License: **IC: 216Q-1780**

HVIN: **ENW89854C1KF, ENW89854C2KF**

Il est recommandé aux fabricants d'appareils fixes, mobiles ou portables de consulter la réglementation en vigueur et de vérifier la conformité de leurs produits relativement aux limites d'exposition aux rayonnements radiofréquence ainsi qu'au débit d'absorption spécifique maximum autorisé.

Des informations pour les utilisateurs sur la réglementation Canadienne concernant l'exposition aux rayonnements RF sont disponibles sur le site www.ic.gc.ca.

Ce produit a été développé pour fonctionner spécifiquement avec les antennes listées dans le tableau ⇒ [6.2.5 Approved Antenna List](#), présentant un gain maximum de +1.4 dBi. Des antennes autres que celles listées ici, ou présentant un gain supérieur à +1.4 dBi ne doivent en aucune circonstance être utilisées en combinaison avec ce produit. L'impédance des antennes compatibles est 50 Ω. L'antenne utilisée avec ce produit ne doit ni être située à proximité d'une autre antenne ou d'un autre émetteur, ni être utilisée conjointement avec une autre antenne ou un autre émetteur.

En raison de la taille du produit, l'identifiant IC est fourni dans le manuel d'installation.



Le client final doit s'assurer que l'appareil se trouve en toutes circonstances à une distance de plus de 15 mm du corps humain.

Si le client final envisage une application nécessitant d'utiliser le PAN1770 à une distance inférieure à 15 mm du corps humain, alors le FEO doit répéter l'évaluation DAS.

L'équipement du client final doit répondre aux exigences actuelles de sécurité et de santé selon l'ISED.

6.3.1 IC Notice

English



The device PAN1770 (⇒ [7.1 Ordering Information](#)), including the antennas (⇒ [6.2.5 Approved Antenna List](#)), complies with Canada RSS-GEN Rules. The device meets the requirements for modular transmitter approval as detailed in RSS-Gen.

Operation is subject to the following two conditions:

1. This device may not cause harmful interference, and
2. This device must accept any interference received, including interference that may cause undesired operation.

French



Le présent appareil PAN1770 (⇒ [7.1 Ordering Information](#)), les antennes y compris (⇒ [6.2.5 Approved Antenna List](#)), est conforme aux CNR-Gen d'Industrie Canada applicables aux appareils radio exempts de licence.

L'exploitation est autorisée aux deux conditions suivantes:

1. L'appareil ne doit pas produire de brouillage, et
2. L'utilisateur de l'appareil doit accepter tout brouillage radioélectrique subi, même si le brouillage est susceptible d'en compromettre le fonctionnement.

6.3.2 Labeling Requirements

English



Labeling Requirements

The OEM must ensure that IC labelling requirements are met. This includes a clearly visible label on the outside of the OEM enclosure specifying the appropriate Panasonic IC identifier for this product as well as the IC Notice above.

The IC identifier is **IC: 216Q-1780**.

This IC identifier is valid for all PAN1770 modules ⇒ [7.1 Ordering Information](#). In any case, the end product must be labelled on the exterior with:

"Contains IC: 216Q-1780".

French



Obligations d'étiquetage

Les fabricants d'équipements d'origine (FEO) – en anglais Original Equipment Manufacturer (OEM) – doivent s'assurer que les obligations d'étiquetage IC du produit final sont remplies. Ces obligations incluent une étiquette clairement visible à l'extérieur de l'emballage externe, comportant l'identifiant IC du module Panasonic inclus, ainsi que la notification ci-dessus.

L'identifiant IC est **IC: 216Q-1780**.

Cet identifiant est valide pour tous les modules PAN1770 ⇒ [7.1 Ordering Information](#). Dans tous les cas les produits finaux doivent indiquer sur leur emballage externe la mention suivante:

"Contient IC: 216Q-1780".

6.4 European Conformity According to RED (2014/53/EU)

All modules described in this Product Specification comply with the standards according to the following LVD (2014/35/EU), EMC-D (2014/30/EU) together with RED (2014/53/EU) articles:

3.1a Safety/Health: EN 62368-1: 2014/AC: 2015/A11: 2017
EN 62479: 2010

3.1b EMC: EN 301 489-1 V2.2.3: (2019-11)
EN 301 489-17 V3.2.2: (2019-02)

3.2 Radio: EN 300 328 V2.2.2: (2019-07)

- Due to the model size, the CE marking is displayed in the installation instruction only and it cannot be displayed conform to regulation (EU) No. 765/2008 in 5 mm height on the module's label due to the limited space.
- The RED EU Type Examination Certificate No. **T818970P** issued by the Notified Body 0682 can be used for the OEM end product conformity assessment. If a Notified Body has been contracted for the end product conformity assessment, it should be noted that this EU Type Examination Certificate should be used for conformance assessment.

As a result of the conformity assessment procedure described in 2014/53/EU Directive, the end customer equipment should be labelled as follows:



The requirements for CE marking are described in regulation (EC) No. 765/2008 Annex II.



The end customer has to assure that the device has a distance of more than 5 mm from the human body under all circumstances.

If the end customer application intends to use the PAN1770 in a distance smaller 5 mm from the human body, SAR evaluation has to be repeated by the OEM.

The end customer equipment must meet the actual Safety/Health requirements according to RED.

PAN1770 and its model versions in the specified reference design can be used in all countries of the European Economic Area (Member States of the EU, European Free Trade Association States [Iceland, Liechtenstein, Norway]), Monaco, San Marino, Andorra, and Turkey.

6.5 Bluetooth

The final Bluetooth end product listing needs to be created by using the following IDs:

Bluetooth 5.1	Declaration ID	QDID
End product	D050150	148922

Bluetooth Marks

According to the Bluetooth SIG, the PAN1770 fulfills the criteria to label your product as a Bluetooth device:



For further information please refer to the Bluetooth website www.bluetooth.com.

6.6 RoHS and REACH Declaration

The latest declaration of environmental compatibility (Restriction of Hazardous Substances, RoHS and Registration, Evaluation, Authorisation and Restriction of Chemicals, REACH) for supplied products can be found on the Panasonic website in the “Downloads” section of the respective product ⇒ [7.2.2 Product Information](#).

7 Appendix

7.1 Ordering Information

Variants and Versions

Order Number	Brand Name	Description	MOQ ¹
ENW89854C1KF ²	PAN1770	Bluetooth Low Energy Single Mode with U.FL connector Empty Flash	1 500
ENW89854C2KF ²	PAN1770	Bluetooth Low Energy Single Mode with U.FL connector Access Port Protection APPROTECT HW Empty Flash	1 500

¹ Abbreviation for Minimum Order Quantity (MOQ). The default MOQ for mass production is 1 500 pieces, fewer only on customer demand. Samples for evaluation can be delivered at any quantity via the distribution channels.

² Samples are available on customer demand.

7.2 Contact Details

7.2.1 Contact Us

Please contact your local Panasonic Sales office for details on additional product options and services:

For Panasonic Sales assistance in the **EU**, visit

<https://eu.industrial.panasonic.com/about-us/contact-us>

Email: wireless@eu.panasonic.com

For Panasonic Sales assistance in **North America**, visit the Panasonic website “Sales & Support” to find assistance near you at

<https://na.industrial.panasonic.com/distributors>

Please visit the **Panasonic Wireless Technical Forum** to submit a question at

<https://forum.na.industrial.panasonic.com>

7.2.2 Product Information

Please refer to the Panasonic Wireless Connectivity website for further information on our products and related documents:

For complete Panasonic product details in the **EU**, visit

<http://pideu.panasonic.de/products/wireless-modules.html>

For complete Panasonic product details in **North America**, visit

<http://www.panasonic.com/rfmodules>

Mouser Electronics

Authorized Distributor

Click to View Pricing, Inventory, Delivery & Lifecycle Information:

Panasonic:

[ENW-89854C1KF](#) [ENW-89854C2KF](#)