

TOSHIBA CMOS Linear Integrated Circuit Silicon Monolithic

# TCK111G, TCK112G

## 3A, 8 mΩ Ultra Low On Resistance Load Switch IC with Reverse Current Blocking and Thermal Shutdown function

The TCK111G and TCK112G are Load Switch ICs for power management with Reverse Current Blocking and Thermal Shutdown function featuring ultra low switch on resistance, high output current and wide input voltage operation from 1.1 to 5.5 V. Switch ON resistance is only 8.3 mΩ (typ.) at  $V_{IN} = 5.0$  V, -1.5 A load conditions and output current is available on 3.0 A. And these feature a slew rate control driver and output auto-discharge function.

This device are available in 0.5 mm pitch ultra small package WCSP6C (1.0 mm x 1.5 mm, t: 0.5 mm (typ.)). Thus they are ideal for portable applications that require high-density board assembly such as cellular phone.

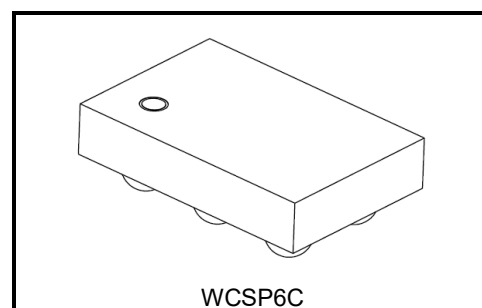

WCSP6C

Weight: 1.4 mg (typ.)

### Feature

- Low ON resistance:
  - $R_{ON} = 8.3$  mΩ (typ.) at  $V_{IN} = 5.0$  V, -1.5 A
  - $R_{ON} = 8.4$  mΩ (typ.) at  $V_{IN} = 3.3$  V, -1.5 A
  - $R_{ON} = 8.4$  mΩ (typ.) at  $V_{IN} = 1.8$  V, -1.5 A
  - $R_{ON} = 8.5$  mΩ (typ.) at  $V_{IN} = 1.1$  V, -1.5 A
- Wide input voltage operation:  $V_{IN} = 1.1$  to 5.5 V
- Reverse current blocking
- Inrush current reducing circuit
- Thermal Shutdown function
- Output auto-discharge ( TCK112G )
- Pull down connection between CONTROL and GND
- Ultra small package : WCSP6C (1.0mm x 1.5mm, t: 0.5 mm(typ.))

### Notice

This device is sensitive to electrostatic discharge. Please ensure equipment and tools are adequately earthed when handling.

Start of commercial production  
2014-04

### Absolute Maximum Ratings (Ta = 25°C)

Characteristics	Symbol	Rating		Unit
Input voltage	V <sub>IN</sub>	-0.3 to 6.0		V
Control voltage	V <sub>CT</sub>	-0.3 to 6.0		V
Output voltage	V <sub>OUT</sub>	-0.3 to 6.0		V
Output current	I <sub>OUT</sub>	DC	3.0	A
		Pulse	4.0 (Note 1)	A
Power dissipation	P <sub>D</sub>	1.2 (Note 2)		W
Operating temperature range	T <sub>opr</sub>	-40 to 85		°C
Junction temperature	T <sub>j</sub>	150		°C
Storage temperature	T <sub>stg</sub>	-55 to 150		°C

Note: Using continuously under heavy loads (e.g. the application of high temperature/current/voltage and the significant change in temperature, etc.) may cause this product to decrease in the reliability significantly even if the operating conditions (i.e. operating temperature/current/voltage, etc.) are within the absolute maximum ratings and the operating ranges. Please design the appropriate reliability upon reviewing the Toshiba Semiconductor Reliability Handbook ("Handling Precautions"/"Derating Concept and Methods") and individual reliability data (i.e. reliability test report and estimated failure rate, etc).

Note1: 100 μs pulse, 2% duty cycle

Note2: Rating at mounting on a board

(Board material: Glass epoxy (FR4))

Board dimension: 25.4mm x 25.4mm (both sides of board), t=1.6mm, Cu pad area: 645mm<sup>2</sup>)

### Pin Assignment (Top view)

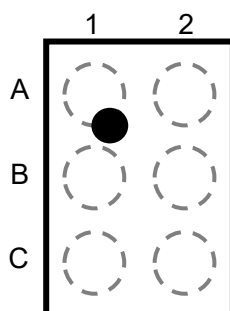

A1: VOUT  
 B1: VOUT  
 C1: GND  
 A2: VIN  
 B2: VIN  
 C2: CONTROL

### Top marking

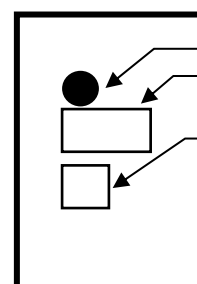

Index  
 Lot trace code  
 V: TCK111G  
 W: TCK112G

### Block Diagram

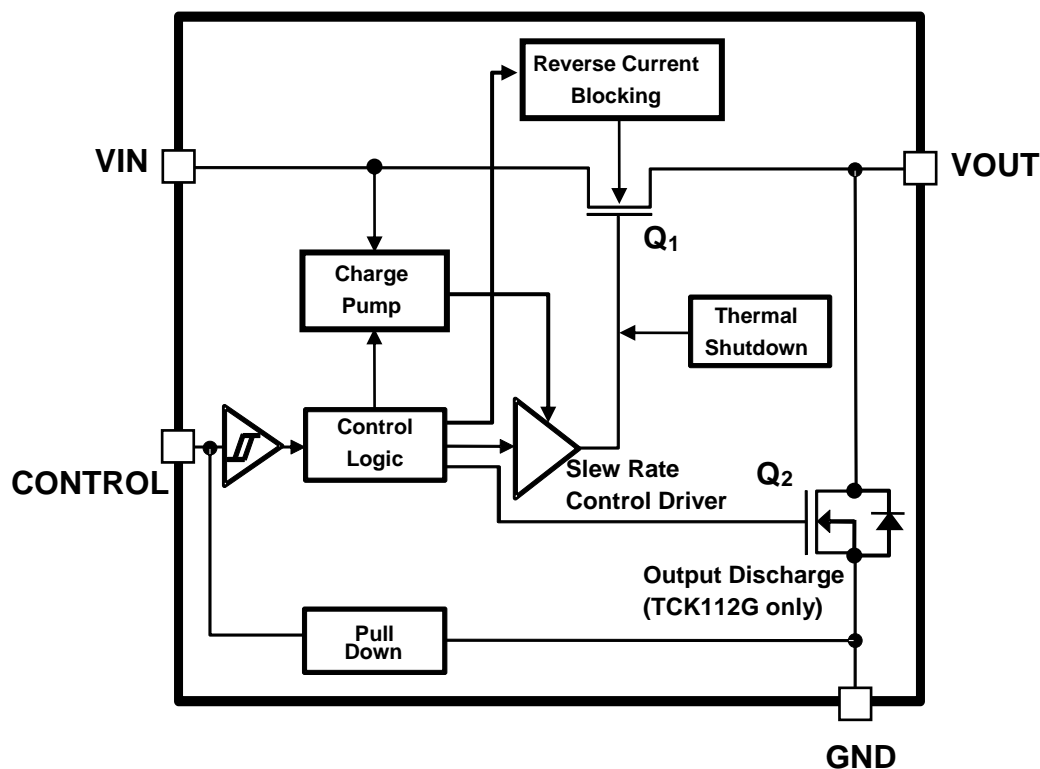

### Function table

Part number	Function			
	Reverse current blocking	Thermal shutdown	Output auto-discharge	Control pin connection
TCK111G	Built in	Built in	N/A	Pull down
TCK112G	Built in	Built in	Built in	Pull down

### Operation Logic table

$1.1\text{ V} \leq V_{IN} \leq 5.5\text{ V}$  ( $T_a = -40$  to  $85^\circ\text{C}$ )

		TCK111G	TCK112G
Control "High"	Output Q <sub>1</sub>	ON	ON
	Discharge Q <sub>2</sub>	—	OFF
	Reverse current block	Active	Active
Control "Low"	Output Q <sub>1</sub>	OFF	OFF
	Discharge Q <sub>2</sub>	—	ON
	Reverse current block	Active	Active
Control "OPEN"	Output Q <sub>1</sub>	OFF	OFF
	Discharge Q <sub>2</sub>	—	ON
	Reverse current block	Active	Active

### Electrical Characteristics

#### DC Characteristics (Ta = -40 to 85°C)

Characteristics	Symbol	Test Condition	Ta = 25°C			Ta = -40 to 85°C		Unit	
			Min	Typ.	Max	Min	Max		
Input voltage	V <sub>IN</sub>	—	1.1	—	5.5	1.1	5.5	V	
CONTROL High-level input voltage	V <sub>IH</sub>	1.2V < V <sub>IN</sub> ≤ 5.5 V	1.0	—	—	1.0	—	V	
		1.1V ≤ V <sub>IN</sub> ≤ 1.2 V	0.9	—	—	0.9	—		
CONTROL Low-level input voltage	V <sub>IL</sub>	V <sub>IN</sub> = 1.1 to 5.5 V	—	—	0.4	—	0.4	V	
Quiescent current ( ON state)	I <sub>Q</sub>	I <sub>OUT</sub> = 0 mA	V <sub>IN</sub> = V <sub>CT</sub> = 1.1 V	—	55	—	—	—	μA
			V <sub>IN</sub> = V <sub>CT</sub> = 1.8 V	—	50	—	—	—	μA
			V <sub>IN</sub> = V <sub>CT</sub> = 3.3 V	—	48	—	—	—	μA
			V <sub>IN</sub> = V <sub>CT</sub> = 5.0 V	—	69	—	—	106	μA
Standby current ( OFF state)	I <sub>Q(OFF)</sub>	V <sub>IN</sub> = 5.5 V, V <sub>CT</sub> = 0 V, V <sub>OUT</sub> = OPEN (Note 3)	—	0.5	—	—	1.4	μA	
Reverse blocking current	I <sub>RB</sub>	V <sub>OUT</sub> = 5.0 V, V <sub>IN</sub> = 0 V, V <sub>CT</sub> = 0 V	—	0.6	—	—	10	μA	
Reverse blocking voltage threshold	V <sub>RB</sub>	V <sub>OUT</sub> - V <sub>IN</sub>	—	40	—	—	—	mV	
Reverse blocking release voltage threshold	V <sub>RB(R)</sub>	V <sub>OUT</sub> - V <sub>IN</sub>	—	-30	—	—	—	mV	
On resistance	R <sub>ON</sub>	I <sub>OUT</sub> = -1.5 A	V <sub>IN</sub> = 5.0 V	—	8.3	—	—	15	mΩ
			V <sub>IN</sub> = 3.3 V	—	8.4	—	—	—	
			V <sub>IN</sub> = 1.8 V	—	8.4	—	—	—	
			V <sub>IN</sub> = 1.1 V	—	8.5	—	—	15	
Output discharge on resistance	R <sub>SD</sub>	— (TCK112G)	—	380	—	—	—	Ω	

Note 3 : Except OFF-state switch current ( I<sub>SD(OFF)</sub> : V<sub>IN</sub> = 5.5 V, V<sub>CT</sub> = 0 V, V<sub>OUT</sub> = GND ).

#### AC Characteristics (Ta = 25°C)

Characteristics	Symbol	Test Condition(Figure 1)	Min	Typ.	Max	Unit
V <sub>OUT</sub> rise time	t <sub>r</sub>	V <sub>IN</sub> = 5.0 V, R <sub>L</sub> = 2.5 Ω, C <sub>L</sub> = 1.0 μF	—	0.5	—	ms
V <sub>OUT</sub> fall time	t <sub>f</sub>	V <sub>IN</sub> = 5.0 V, R <sub>L</sub> = 2.5 Ω, C <sub>L</sub> = 1.0 μF	—	5	—	μs
Turn on delay	t <sub>ON</sub>	V <sub>IN</sub> = 5.0 V, R <sub>L</sub> = 2.5 Ω, C <sub>L</sub> = 1.0 μF	—	0.2	—	ms
Turn off delay	t <sub>OFF</sub>	V <sub>IN</sub> = 5.0 V, R <sub>L</sub> = 2.5 Ω, C <sub>L</sub> = 1.0 μF	—	4	—	μs

#### AC Waveform

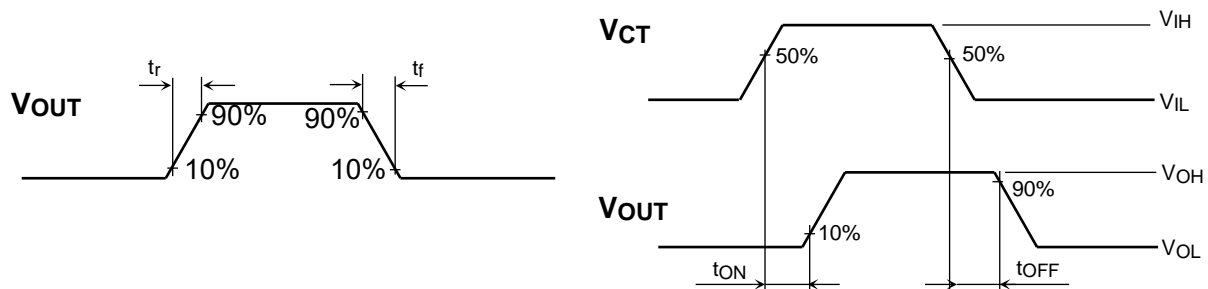
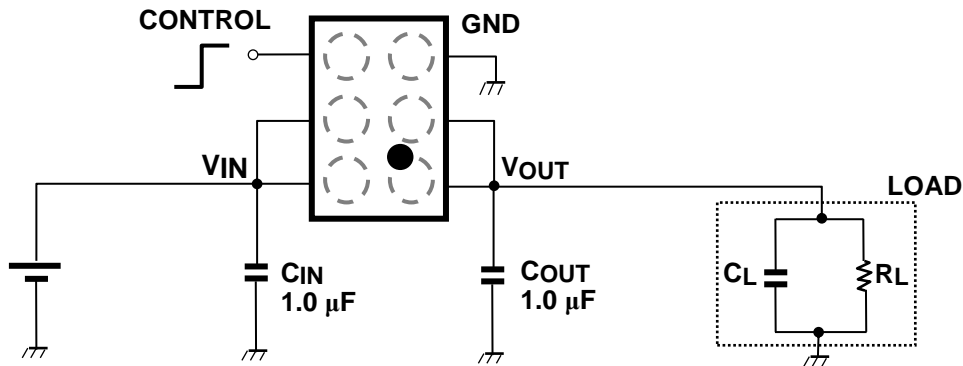

Figure 1 t<sub>r</sub>, t<sub>f</sub>, t<sub>ON</sub>, t<sub>OFF</sub> Waveforms

## Application Note

### 1. Application circuit example (top view)

The figure below shows the example of configuration for TCK111G and TCK112G.



#### 1) Input and Output capacitor

An input capacitor ( $C_{IN}$ ) and an output capacitor ( $C_{OUT}$ ) are necessary for the stable operation of TCK111G and TCK112G. They are effective to reduce voltage overshoot or undershoot due to sharp changes in output current and also for improved stability of the power supply. When used, place  $C_{IN}$  and  $C_{OUT}$  more than  $1.0\mu\text{F}$  as close to  $V_{IN}$  pin to improve stability of the power supply.

#### 2) Control pin

Control pins for TCK111G and TCK112G are both Active High, which control both the pass-through n-ch MOSFET and the discharge n-ch MOSFET (only for TCK112G), operated by the control voltage. Each control pin is equipped with Schmitt trigger. When the control voltage level is High, Output n-ch MOSFET is ON state and discharge n-ch MOSFET is OFF state. When control voltage level is Low, and the state of the MOSFETs is reversed. Also, pull down resistance equivalent to a few  $\text{M}\Omega$  is connected between CONTROL and GND, thus the load switch IC is in OFF state even when CONTROL pin is OPEN. In addition, CONTROL pin has a tolerant function such that it can be used even if the control voltage is higher than the input voltage.

### 2. Reverse current blocking

Reverse current blocking function is designed in these products. This function is active regardless output n-ch MOSFET ON/OFF state in condition that  $V_{IN}$  is supplied

However these do not assure for the suppression of uprising device operation. In use of these products, please read through and understand dissipation idea for absolute maximum ratings from the above mention or our 'Semiconductor Reliability Handbook'. Then use these products under absolute maximum ratings in any condition. Furthermore, Toshiba recommends inserting failsafe system into the design.

### 3. Thermal shutdown function

Thermal shutdown function is designed in these products, but it does not assure for the suppression of uprising device operation. In use of these products, please read through and understand dissipation idea for absolute maximum ratings from the above mention or our 'Semiconductor Reliability Handbook'. Then use these products under absolute maximum ratings in any condition. Furthermore, Toshiba recommends inserting failsafe system into the design.

### 4. Power Dissipation

Board-mounted power dissipation ratings for TCK111G and TCK112G are available in the Absolute Maximum Ratings table.

Power dissipation is measured on the board condition shown below.

[The Board Condition]

Board material: Glass epoxy (FR4)

Board dimension: 25.4mm x 25.4mm (both sides of board), t=1.6mm, Cu pad area: 645mm<sup>2</sup>

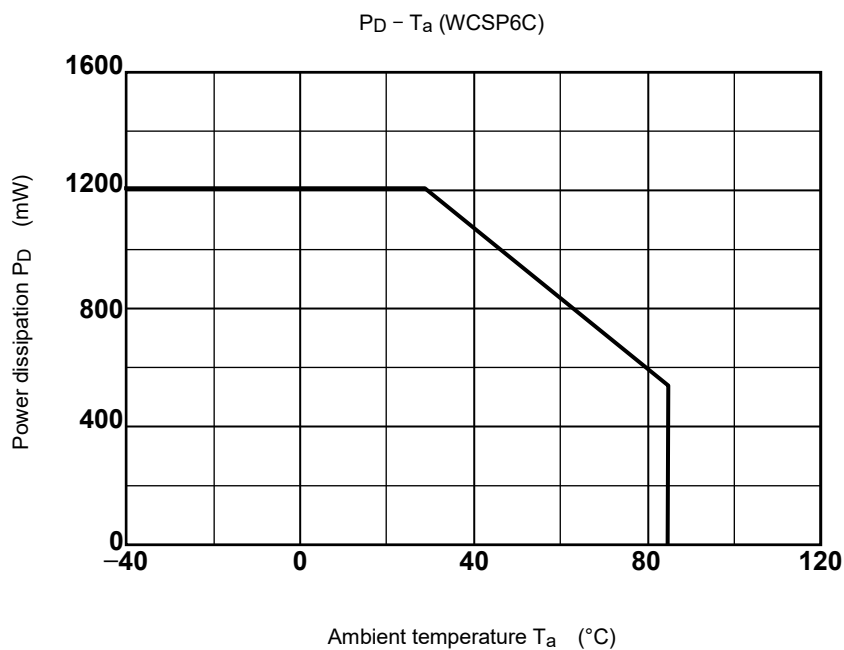

Please allow sufficient margin when designing a board pattern to fit the expected power dissipation. Also take into consideration the ambient temperature, input voltage, output current etc. and applying the appropriate derating for allowable power dissipation during operation.

### Representative Typical Characteristics

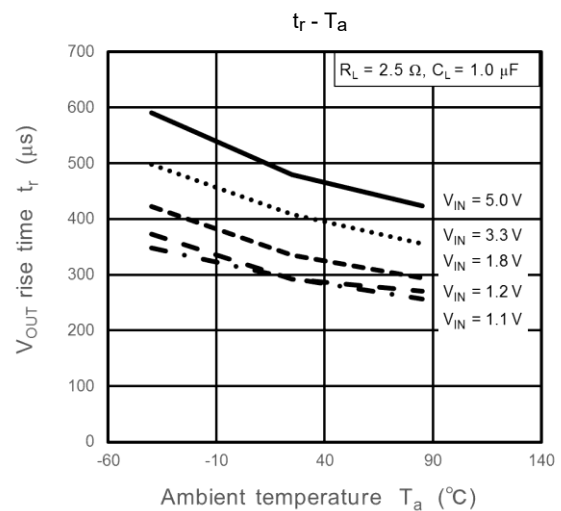
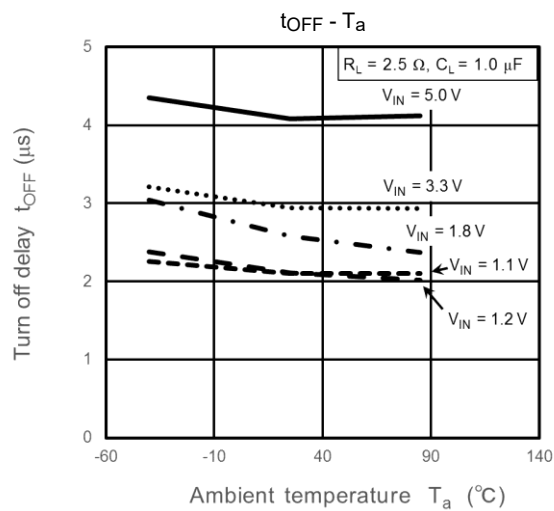
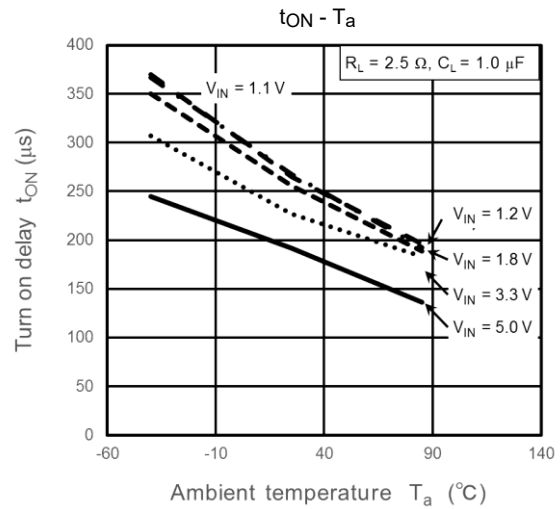
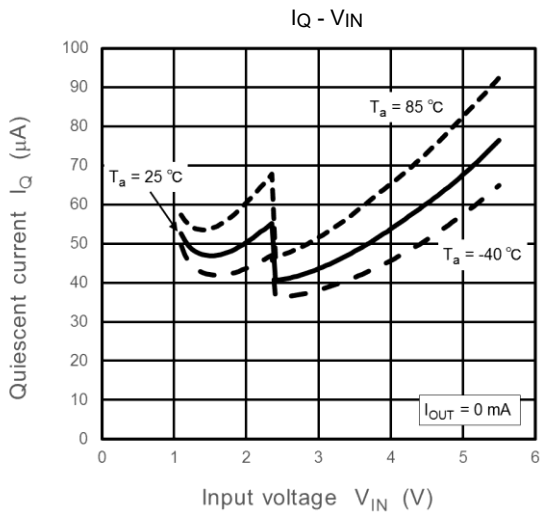
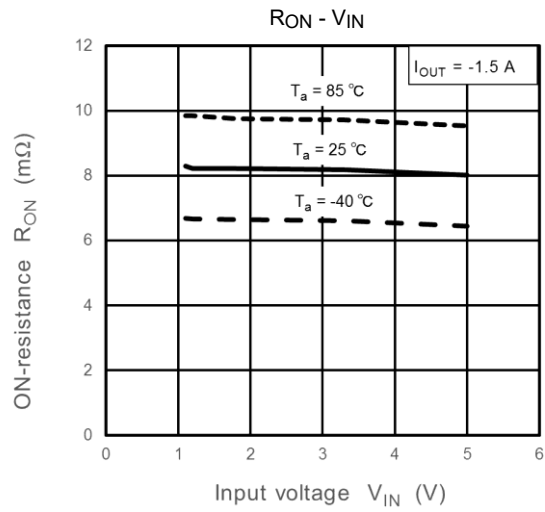
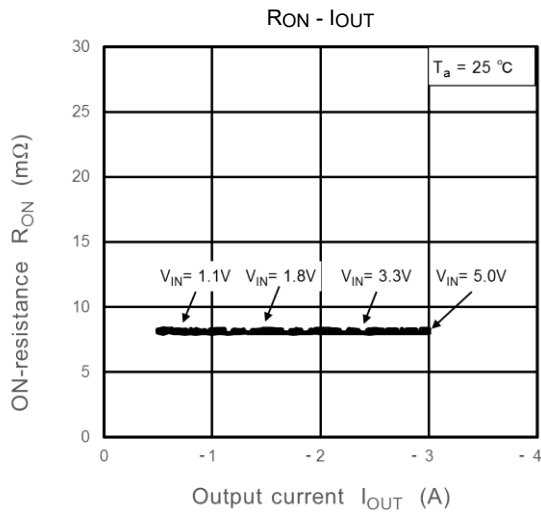

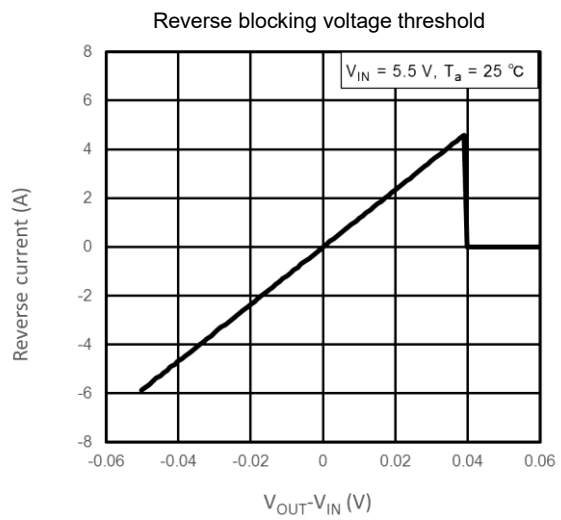
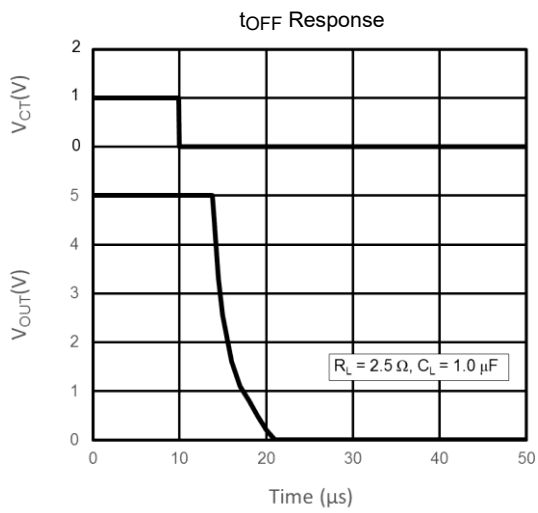
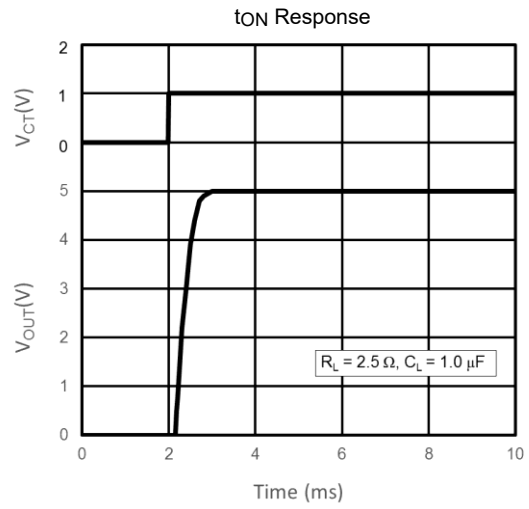
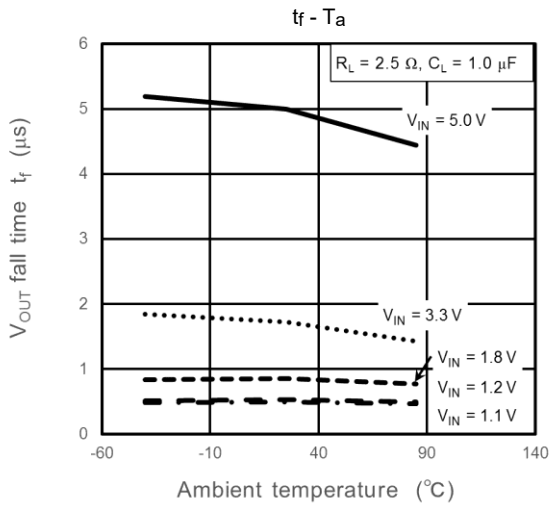

Note: The above characteristics curves are presented for reference only and not guaranteed by production test, unless otherwise noted.

### Package Information

WCSP6C

Unit: mm

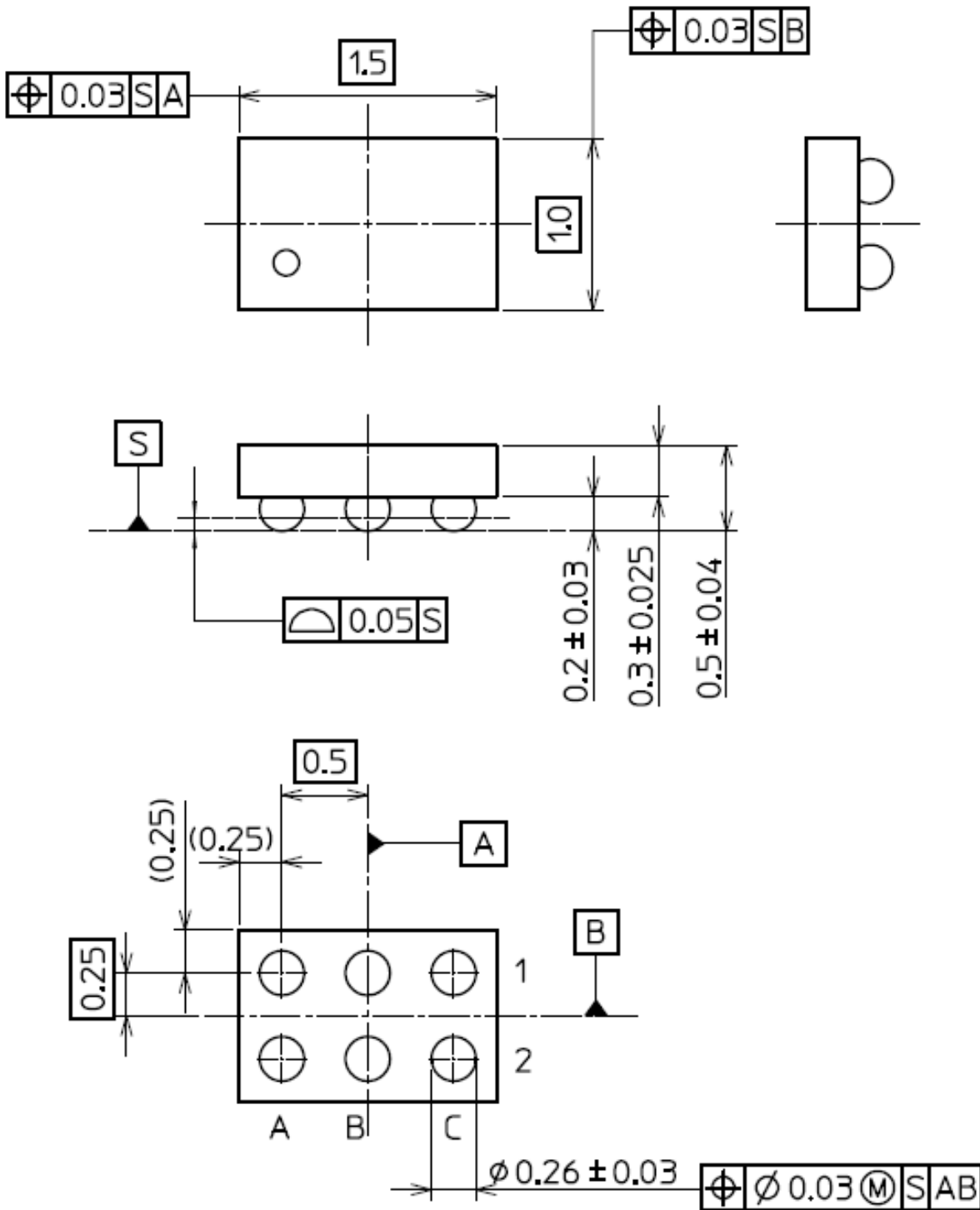

Weight: 1.4 mg (typ.)

## RESTRICTIONS ON PRODUCT USE

Toshiba Corporation and its subsidiaries and affiliates are collectively referred to as "TOSHIBA". Hardware, software and systems described in this document are collectively referred to as "Product".

- TOSHIBA reserves the right to make changes to the information in this document and related Product without notice.
- This document and any information herein may not be reproduced without prior written permission from TOSHIBA. Even with TOSHIBA's written permission, reproduction is permissible only if reproduction is without alteration/omission.
- Though TOSHIBA works continually to improve Product's quality and reliability, Product can malfunction or fail. Customers are responsible for complying with safety standards and for providing adequate designs and safeguards for their hardware, software and systems which minimize risk and avoid situations in which a malfunction or failure of Product could cause loss of human life, bodily injury or damage to property, including data loss or corruption. Before customers use the Product, create designs including the Product, or incorporate the Product into their own applications, customers must also refer to and comply with (a) the latest versions of all relevant TOSHIBA information, including without limitation, this document, the specifications, the data sheets and application notes for Product and the precautions and conditions set forth in the "TOSHIBA Semiconductor Reliability Handbook" and (b) the instructions for the application with which the Product will be used with or for. Customers are solely responsible for all aspects of their own product design or applications, including but not limited to (a) determining the appropriateness of the use of this Product in such design or applications; (b) evaluating and determining the applicability of any information contained in this document, or in charts, diagrams, programs, algorithms, sample application circuits, or any other referenced documents; and (c) validating all operating parameters for such designs and applications. **TOSHIBA ASSUMES NO LIABILITY FOR CUSTOMERS' PRODUCT DESIGN OR APPLICATIONS.**
- **PRODUCT IS NEITHER INTENDED NOR WARRANTED FOR USE IN EQUIPMENTS OR SYSTEMS THAT REQUIRE EXTRAORDINARILY HIGH LEVELS OF QUALITY AND/OR RELIABILITY, AND/OR A MALFUNCTION OR FAILURE OF WHICH MAY CAUSE LOSS OF HUMAN LIFE, BODILY INJURY, SERIOUS PROPERTY DAMAGE AND/OR SERIOUS PUBLIC IMPACT ("UNINTENDED USE").** Except for specific applications as expressly stated in this document, Unintended Use includes, without limitation, equipment used in nuclear facilities, equipment used in the aerospace industry, lifesaving and/or life supporting medical equipment, equipment used for automobiles, trains, ships and other transportation, traffic signaling equipment, equipment used to control combustions or explosions, safety devices, elevators and escalators, and devices related to power plant. **IF YOU USE PRODUCT FOR UNINTENDED USE, TOSHIBA ASSUMES NO LIABILITY FOR PRODUCT.** For details, please contact your TOSHIBA sales representative or contact us via our website.
- Do not disassemble, analyze, reverse-engineer, alter, modify, translate or copy Product, whether in whole or in part.
- Product shall not be used for or incorporated into any products or systems whose manufacture, use, or sale is prohibited under any applicable laws or regulations.
- The information contained herein is presented only as guidance for Product use. No responsibility is assumed by TOSHIBA for any infringement of patents or any other intellectual property rights of third parties that may result from the use of Product. No license to any intellectual property right is granted by this document, whether express or implied, by estoppel or otherwise.
- **ABSENT A WRITTEN SIGNED AGREEMENT, EXCEPT AS PROVIDED IN THE RELEVANT TERMS AND CONDITIONS OF SALE FOR PRODUCT, AND TO THE MAXIMUM EXTENT ALLOWABLE BY LAW, TOSHIBA (1) ASSUMES NO LIABILITY WHATSOEVER, INCLUDING WITHOUT LIMITATION, INDIRECT, CONSEQUENTIAL, SPECIAL, OR INCIDENTAL DAMAGES OR LOSS, INCLUDING WITHOUT LIMITATION, LOSS OF PROFITS, LOSS OF OPPORTUNITIES, BUSINESS INTERRUPTION AND LOSS OF DATA, AND (2) DISCLAIMS ANY AND ALL EXPRESS OR IMPLIED WARRANTIES AND CONDITIONS RELATED TO SALE, USE OF PRODUCT, OR INFORMATION, INCLUDING WARRANTIES OR CONDITIONS OF MERCHANTABILITY, FITNESS FOR A PARTICULAR PURPOSE, ACCURACY OF INFORMATION, OR NONINFRINGEMENT.**
- Do not use or otherwise make available Product or related software or technology for any military purposes, including without limitation, for the design, development, use, stockpiling or manufacturing of nuclear, chemical, or biological weapons or missile technology products (mass destruction weapons). Product and related software and technology may be controlled under the applicable export laws and regulations including, without limitation, the Japanese Foreign Exchange and Foreign Trade Law and the U.S. Export Administration Regulations. Export and re-export of Product or related software or technology are strictly prohibited except in compliance with all applicable export laws and regulations.
- Please contact your TOSHIBA sales representative for details as to environmental matters such as the RoHS compatibility of Product. Please use Product in compliance with all applicable laws and regulations that regulate the inclusion or use of controlled substances, including without limitation, the EU RoHS Directive. **TOSHIBA ASSUMES NO LIABILITY FOR DAMAGES OR LOSSES OCCURRING AS A RESULT OF NONCOMPLIANCE WITH APPLICABLE LAWS AND REGULATIONS.**

# Mouser Electronics

Authorized Distributor

Click to View Pricing, Inventory, Delivery & Lifecycle Information:

[Toshiba:](#)

[TCK112G,LF](#)