

63241-3 ✓ ACTIVE

FASTIN-FASTON | FASTIN-FASTON 110

TE Internal #: 63241-3

Quick Disconnects, Receptacle, 22 – 18 AWG Wire Size, .32 – .82 mm<sup>2</sup> Wire Size, Mating Tab Width 2.8 mm [.11 in], Straight, Brass, FASTIN-FASTON 110

[View on TE.com >](#)



Terminals & Splices > Quick Disconnects

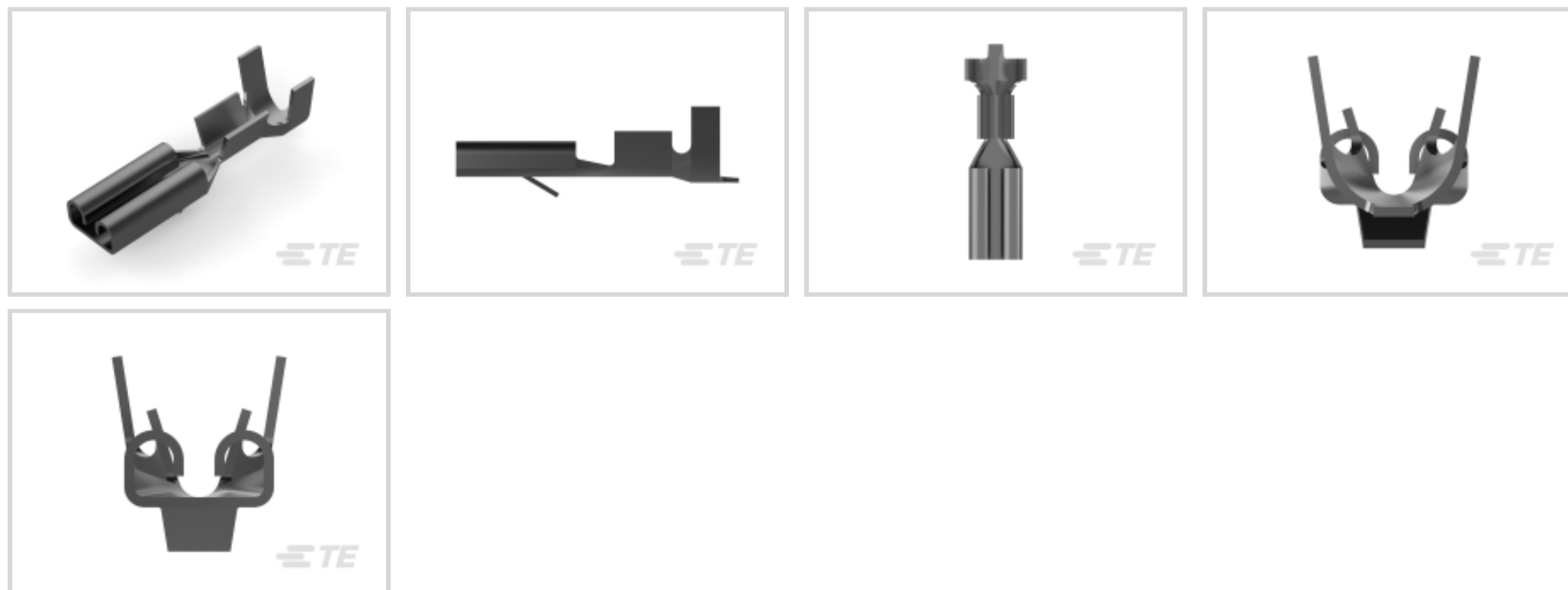

Quick Disconnect Terminal Type: **Receptacle**

Wire Size: .32 – .82 mm<sup>2</sup>

Mating Tab Width: 2.8 mm [.11 in]

Mating Tab Thickness: .51 mm [.02 in]

## Features

### Product Type Features

Insertion Force	Normal
-----------------	--------

### Configuration Features

Connection Capacity	Single
Compatible With Wire & Cable Type	Discrete Wire

### Contact Features

Quick Disconnect Terminal Type	Receptacle
Mating Tab Width	2.8 mm [.11 in]
Mating Tab Thickness	.51 mm [.02 in]
Terminal Orientation	Straight
Contact Base Material	Brass
Terminal Plating Material	Pre-Tin
Crimp Type	F-Crimp
Barrel Type	Open

### Termination Features



Product Terminates To	Wire & Cable
-----------------------	--------------

### Mechanical Attachment

Wire Insulation Support	With
Mating Retention Type	Locking Lance

### Dimensions

Terminal Material Thickness	6.35 mm[.25 in]
Product Length	13.97 mm[.55 in]
Compatible Insulation Diameter Range	2.03 – 3.05 mm[.08 – .12 in]
Wire Size	.32 – .82 mm <sup>2</sup>

### Usage Conditions

Insulation Option	Uninsulated
Operating Temperature Range	-40 – 110 °C[-40 – 230 °F]

### Packaging Features

Packaging Quantity	9000
Packaging Method	Strip/Reel

### Product Compliance

[For compliance documentation, visit the product page on TE.com>](#)

EU RoHS Directive 2011/65/EU	Compliant
EU ELV Directive 2000/53/EC	Compliant
China RoHS 2 Directive MIIT Order No 32, 2016	No Restricted Materials Above Threshold
EU REACH Regulation (EC) No. 1907/2006	Current ECHA Candidate List: JAN 2023 (233) Candidate List Declared Against: JAN 2023 (233) Does not contain REACH SVHC
Halogen Content	Low Halogen - Br, Cl, F, I < 900 ppm per homogenous material. Also BFR/CFR/PVC Free
Solder Process Capability	Not applicable for solder process capability

#### Product Compliance Disclaimer

This information is provided based on reasonable inquiry of our suppliers and represents our current actual knowledge based on the information they provided. This information is subject to change. The part numbers that TE has identified as EU RoHS compliant have a maximum concentration of 0.1% by weight in homogenous materials for lead, hexavalent chromium, mercury, PBB, PBDE, DBP, BBP, DEHP, DIBP, and 0.01% for cadmium, or qualify for an exemption to these limits as defined in the Annexes of Directive 2011/65/EU (RoHS2). Finished electrical and electronic equipment products will be CE marked as required by Directive 2011/65/EU. Components may not be CE marked. Additionally, the part

numbers that TE has identified as EU ELV compliant have a maximum concentration of 0.1% by weight in homogenous materials for lead, hexavalent chromium, and mercury, and 0.01% for cadmium, or qualify for an exemption to these limits as defined in the Annexes of Directive 2000/53/EC (ELV). Regarding the REACH Regulation, the information TE provides on SVHC in articles for this part number is based on the latest European Chemicals Agency (ECHA) 'Guidance on requirements for substances in articles' posted at this URL: <https://echa.europa.eu/guidance-documents/guidance-on-reach>

## Compatible Parts



TE Part # 2-2150769-1  
OCEAN\_2.0\_Applicator-E-070F140F



TE Part # 2-2150769-2  
OCEAN\_2.0\_Applicator-E-070F140F



TE Part # 2150769-1  
OCEAN\_2.0\_Applicator-E-070F140F



TE Part # 2150769-2  
OCEAN\_2.0\_Applicator-E-070F140F



TE Part # 63580-1  
FF 125 REC 22-18AWG TPBR



**KIT**  
REPRESENTATION ONLY  
TE Part # 7-2150769-7  
OCEAN\_2.0\_SPARE\_PART\_KIT-070F140F

## Also in the Series | FASTIN-FASTON 110



Automotive Housings(6)



Automotive Terminals(5)



Crimp Terminal Housings(34)



Insertion & Extraction Tools(3)

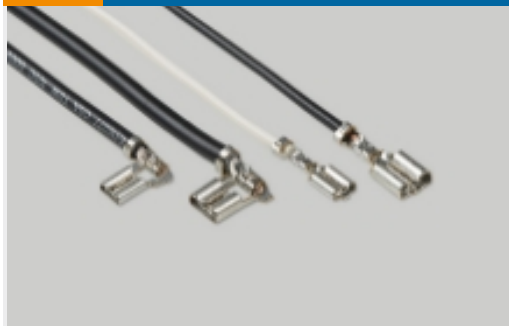

Quick Disconnects(83)

## Customers Also Bought

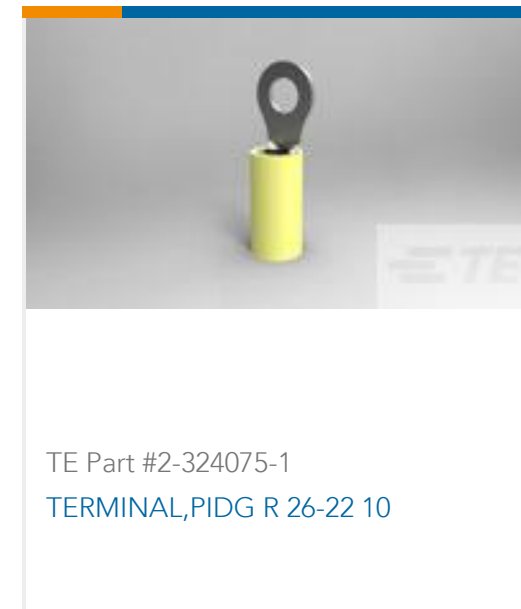
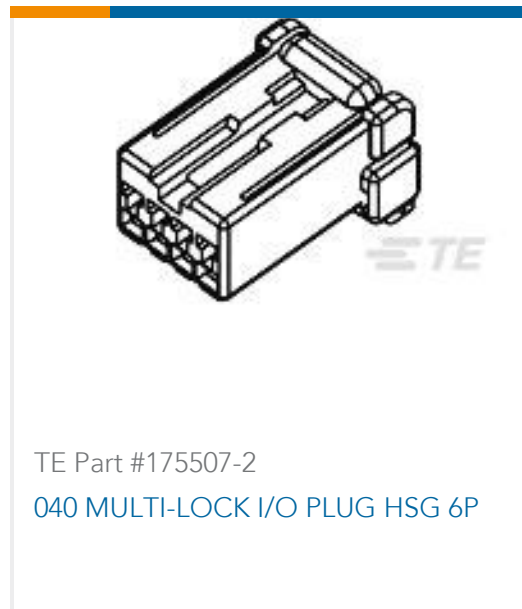

## Documents

### Product Drawings

[FF 110 REC 22-18AWG PTBR](#)

English

### CAD Files

[3D PDF](#)

3D

Customer View Model

[ENG\\_CVM\\_CVM\\_63241-3\\_V\\_c-63241-3-v.2d\\_dxf.zip](#)

English

Customer View Model

[ENG\\_CVM\\_CVM\\_63241-3\\_V\\_c-63241-3-v.3d\\_igs.zip](#)

English

Customer View Model

[ENG\\_CVM\\_CVM\\_63241-3\\_V\\_c-63241-3-v.3d\\_stp.zip](#)

English

By downloading the CAD file I accept and agree to the [Terms and Conditions](#) of use.

### Datasheets & Catalog Pages



## [FASTIN\\_FASTON\\_Product\\_Line](#)

English

---

### [Product Specifications](#)

#### [Application Specification](#)

English

#### [FASTIN-FASTON 110, 187, 205 And 312 Series Receptacle Contacts](#)

English

---

### [Product Environmental Compliance](#)

#### [TE Material Declaration](#)

English