

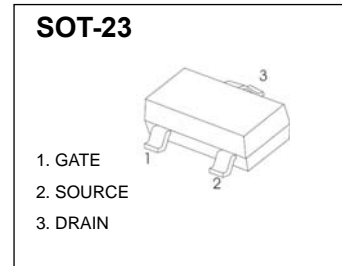

**SOT-23 Plastic-Encapsulate MOSFETS**

**CJ2304** N-Channel MOSFET

$V_{(BR)DSS}$	$R_{DS(on)MAX}$	$I_D$
30V	60mΩ@10V	3.3A
	75mΩ@4.5V	



**FEATURE**

- TrenchFET Power MOSFET

**APPLICATION**

- Load Switch for Portable Devices
- DC/DC Converter

**MARKING: S4**

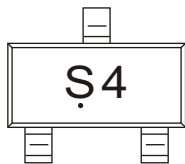

S4 = Device code  
Solid dot = Green molding compound device.

**Equivalent Circuit**

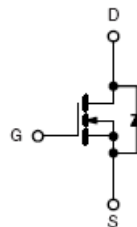

**Maximum ratings ( $T_a=25^{\circ}C$  unless otherwise noted)**

Parameter	Symbol	Value	Unit
Drain-Source Voltage	$V_{DS}$	30	V
Gate-Source Voltage	$V_{GS}$	±20	
Continuous Drain Current	$I_D$	3.3	A
Pulsed Drain Current	$I_{DM}$	15	
Continuous Source-Drain Diode Current	$I_S$	0.9	
Maximum Power Dissipation	$P_D$	0.35	W
Thermal Resistance from Junction to Ambient ( $t \leq 5s$ )	$R_{\theta JA}$	357	$^{\circ}C/W$
Operation Junction and Storage Temperature Range	$T_J, T_{STG}$	-55 ~ +150	$^{\circ}C$

# MOSFET ELECTRICAL CHARACTERISTICS

$T_a=25^\circ\text{C}$  unless otherwise specified

Parameter	Symbol	Test condition	Min	Typ	Max	Units
<b>Static</b>						
Drain-source breakdown voltage	$V_{(BR)DSS}$	$V_{GS} = 0V, I_D = 250\mu A$	30			V
Gate-source threshold voltage	$V_{GS(th)}$	$V_{DS} = V_{GS}, I_D = 250\mu A$	1	1.55	2.2	
Gate-body leakage	$I_{GSS}$	$V_{DS} = 0V, V_{GS} = \pm 20V$			$\pm 100$	nA
Zero gate voltage drain current	$I_{DSS}$	$V_{DS} = 30V, V_{GS} = 0V$			1	$\mu A$
Drain-source on-state resistance <sup>a</sup>	$R_{DS(on)}$	$V_{GS} = 10V, I_D = 3.2A$		0.037	0.060	$\Omega$
		$V_{GS} = 4.5V, I_D = 2.8A$		0.057	0.075	
Forward transconductance <sup>a</sup>	$g_{fs}$	$V_{DS} = 4.5V, I_D = 2.5A$	2.5			S
<b>Dynamic<sup>b</sup></b>						
Total gate charge	$Q_g$	$V_{DS} = 15V, V_{GS} = 10V, I_D = 3.4A$		4.5	6.7	nC
				2.1	3.2	
				0.85		
Gate-source charge	$Q_{gs}$	$V_{DS} = 15V, V_{GS} = 4.5V, I_D = 3.4A$		0.85		
Gate-drain charge	$Q_{gd}$			0.65		
Gate resistance	$R_g$	$f = 1.0\text{MHz}$	0.8	4.4	8.8	$\Omega$
Input capacitance	$C_{iss}$	$V_{DS} = 15V, V_{GS} = 0V, f = 1\text{MHz}$		235		pF
Output capacitance	$C_{oss}$			45		
Reverse transfer capacitance	$C_{rss}$			17		
Turn-on delay Time	$t_{d(on)}$	$V_{DD} = 15V,$ $R_L = 5.6\Omega, I_D \approx 2.7A,$ $V_{GEN} = 4.5V, R_g = 1\Omega$		12	20	ns
Rise time	$t_r$			50	75	
Turn-off delay time	$t_{d(off)}$			12	20	
Fall time	$t_f$			22	35	
Turn-on delay time	$t_{d(on)}$	$V_{DD} = 15V,$ $R_L = 5.6\Omega, I_D \approx 2.7A,$ $V_{GEN} = 10V, R_g = 1\Omega$		5	10	
Rise time	$t_r$			12	20	
Turn-off delay time	$t_{d(off)}$			10	15	
Fall time	$t_f$			5	10	
<b>Drain-source body diode characteristics</b>						
Continuous source-drain diode current	$I_S$	$T_C = 25^\circ\text{C}$			1.4	A
Pulse diode forward current	$I_{SM}$				15	A
Body diode voltage	$V_{SD}$	$I_S = 2.7A, V_{GS} = 0V$		0.8	1.2	V

**Notes :**

- a. Pulse Test : Pulse width  $\leq 300\mu s$ , duty cycle  $\leq 2\%$ .
- b. Guaranteed by design, not subject to production testing.

# Typical Characteristics

Output Characteristics

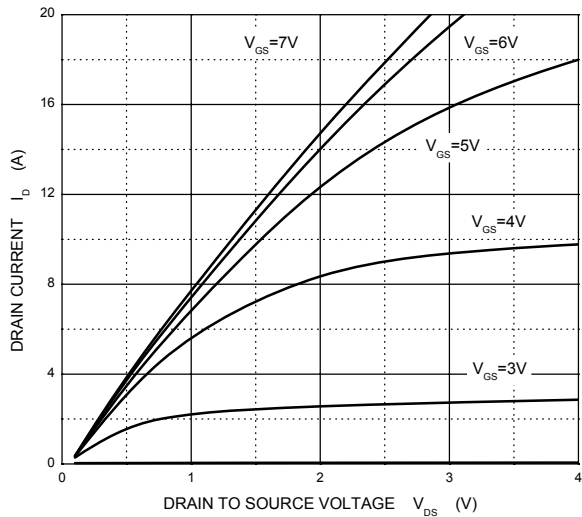

Transfer Characteristics

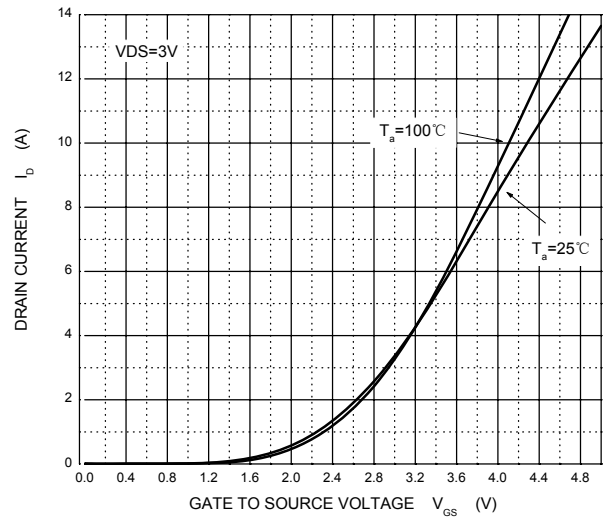

$R_{DS(ON)}$  —  $I_D$

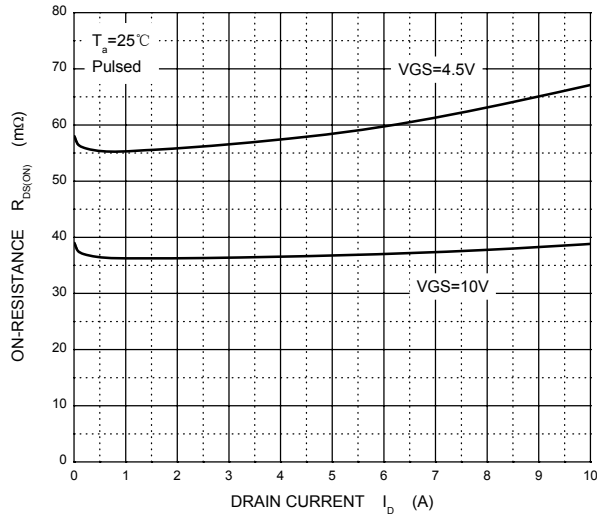

$R_{DS(ON)}$  —  $V_{GS}$

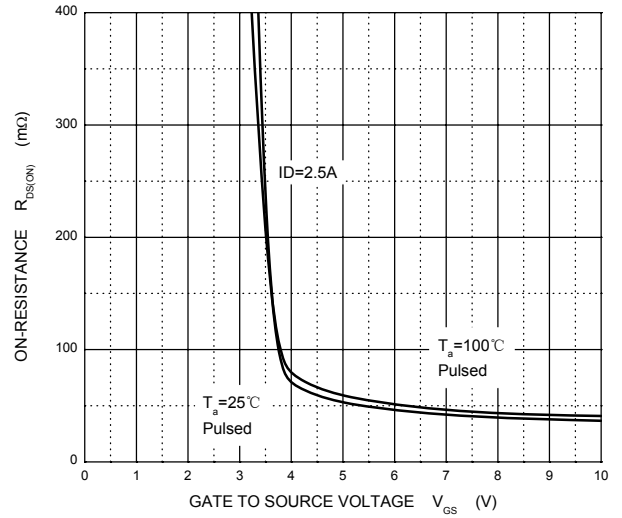

$I_S$  —  $V_{SD}$

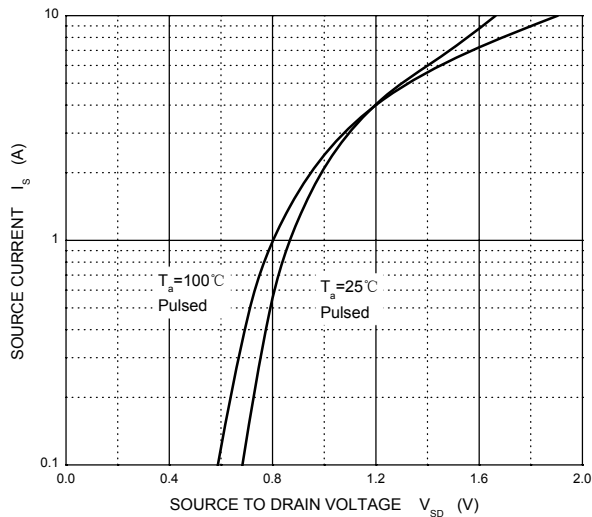

Threshold Voltage

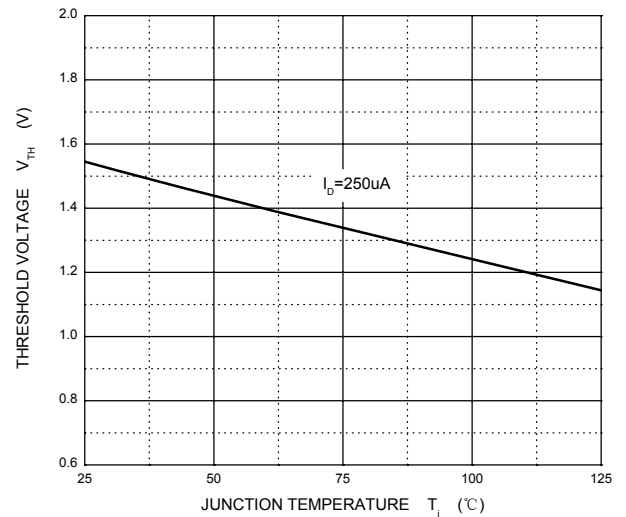

## SOT-23 Package Outline Dimensions

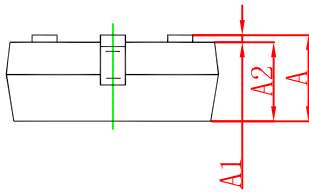
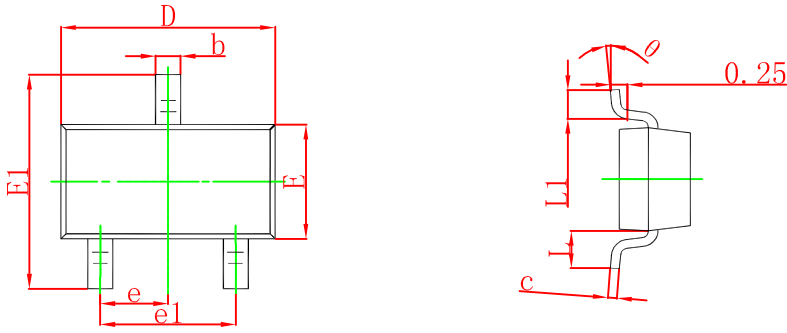

Symbol	Dimensions In Millimeters		Dimensions In Inches	
	Min	Max	Min	Max
A	0.900	1.150	0.035	0.045
A1	0.000	0.100	0.000	0.004
A2	0.900	1.050	0.035	0.041
b	0.300	0.500	0.012	0.020
c	0.080	0.150	0.003	0.006
D	2.800	3.000	0.110	0.118
E	1.200	1.400	0.047	0.055
E1	2.250	2.550	0.089	0.100
e	0.950 TYP		0.037 TYP	
e1	1.800	2.000	0.071	0.079
L	0.550 REF		0.022 REF	
L1	0.300	0.500	0.012	0.020
$\theta$	0°	8°	0°	8°

## SOT-23 Suggested Pad Layout

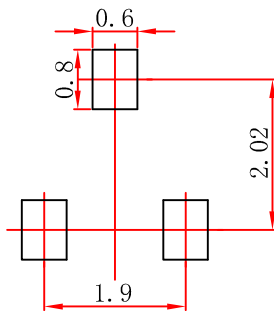

**Note:**

1. Controlling dimension: in millimeters.
2. General tolerance:  $\pm 0.05$  mm.
3. The pad layout is for reference purposes only.

**NOTICE**

JSCJ reserves the right to make modifications, enhancements, improvements, corrections or other changes without further notice to any product herein. JSCJ does not assume any liability arising out of the application or use of any product described herein.

# SOT-23 Tape and Reel

## SOT-23 Embossed Carrier Tape

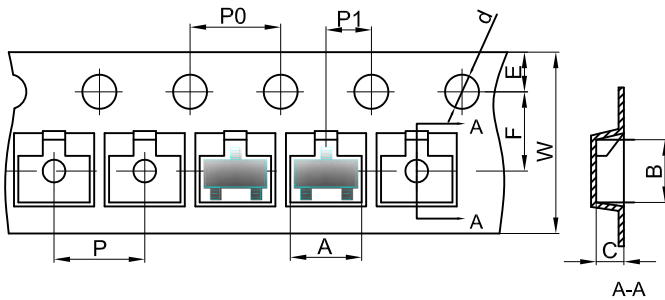

### Packaging Description:

SOT-23 parts are shipped in tape. The carrier tape is made from a dissipative (carbon filled) polycarbonate resin. The cover tape is a multilayer film (Heat Activated Adhesive in nature) primarily composed of polyester film, adhesive layer, sealant, and anti-static sprayed agent. These reeled parts in standard option are shipped with 3,000 units per 7" or 17.8cm diameter reel. The reels are clear in color and is made of polystyrene plastic (anti-static coated).

Dimensions are in millimeter

Pkg type	A	B	C	d	E	F	P0	P	P1	W
SOT-23	3.15	2.77	1.22	Ø1.50	1.75	3.50	4.00	4.00	2.00	8.00

## SOT-23 Tape Leader and Trailer

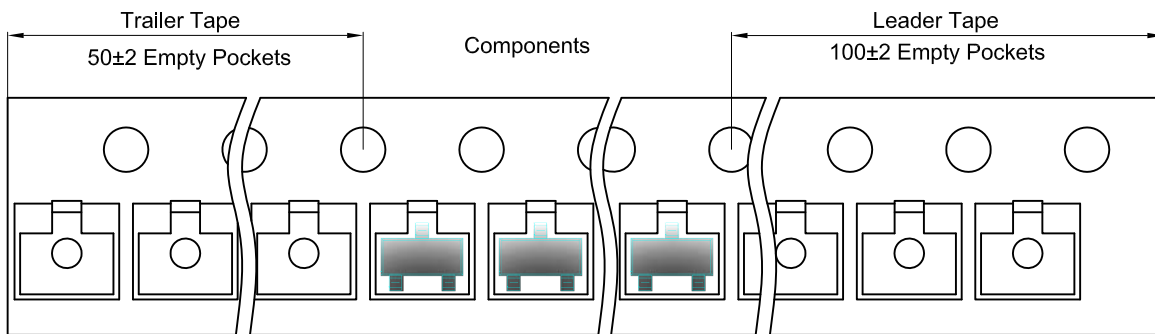

## SOT-23 Reel

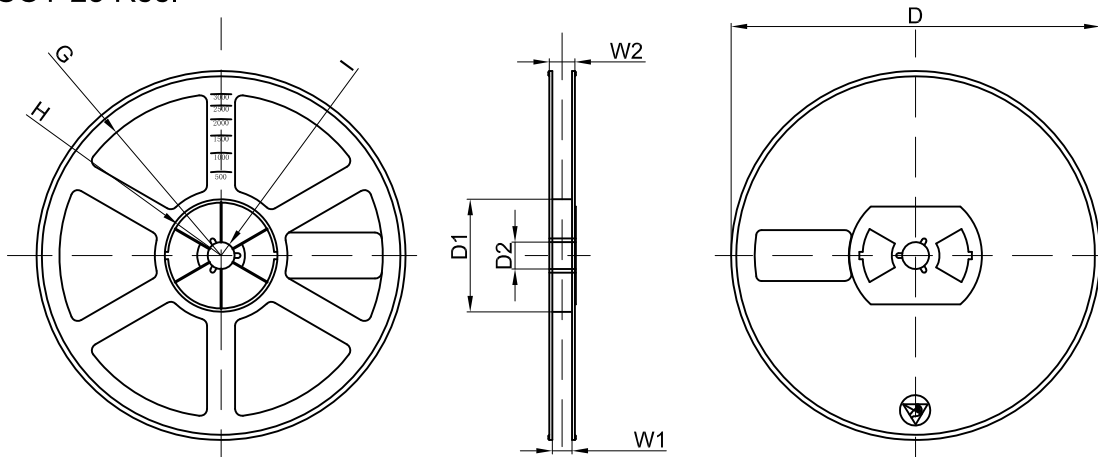

Dimensions are in millimeter

Reel Option	D	D1	D2	G	H	I	W1	W2
7"Dia	Ø178.00	54.40	13.00	R78.00	R25.60	R6.50	9.50	12.30

REEL	Reel Size	Box	Box Size(mm)	Carton	Carton Size(mm)	G.W.(kg)
3000 pcs	7 inch	30,000 pcs	203×203×195	120,000 pcs	438×438×220	