

## CHIP COILS (CHIP INDUCTORS) LQW18AN□□□□8Z□ Murata Standard Standard Specification [AEC-Q200]

### 1. Scope

This reference specification applies to chip coils (chip inductors) LQW18AN\_8Z series for automotive electronics based on AEC-Q200 except for power trains and safeties.

### 2. Part Numbering

(Ex.)

LQ	W	18	A	N	2N2	C	8	Z	D
Product ID	Structure	Dimension (L × W)	Application and characteristic	Category	Inductance	Tolerance	Performance	Category Z: Automotive	Packaging D: taping *B: bulk

\*B: Bulk packing is also available (taping condition: however, products without reels are put in plastic bags).

### 3. Part Number and Rating

Operating temperature range	-55°C to +125°C
Storage temperature range	-55°C to +125°C

Customer Part number	Murata Part number	Inductance		Q (Min.)	DC resistance (Ω max.)	Self-resonant frequency (MHz min.)	Rated current (mA)*1	ESD Rank 6: 25 kV
		Nominal value (nH)	Tolerance					
	LQW18AN2N2C8ZD	2.2	C: ±0.2 nH	24	0.018	15000	3200	6
	LQW18AN2N4C8ZD	2.4	C: ±0.2 nH	18	0.026	15000	2400	6
	LQW18AN3N0C8ZD	3.0	C: ±0.2 nH	13	0.17	15000	670	6
	LQW18AN3N9B8ZD	3.9	B: ±0.1 nH	30	0.028	10000	2200	6
	LQW18AN3N9C8ZD	3.9	C: ±0.2 nH	30	0.028	10000	2200	6
	LQW18AN3N9G8ZD	3.9	G: ±2%	30	0.028	10000	2200	6
	LQW18AN4N1B8ZD	4.1	B: ±0.1 nH	30	0.028	10000	2200	6
	LQW18AN4N1C8ZD	4.1	C: ±0.2 nH	30	0.028	10000	2200	6
	LQW18AN4N1G8ZD	4.1	G: ±2%	30	0.028	10000	2200	6
	LQW18AN4N2B8ZD	4.2	B: ±0.1 nH	30	0.028	10000	2200	6
	LQW18AN4N2C8ZD	4.2	C: ±0.2 nH	30	0.028	10000	2200	6
	LQW18AN4N2G8ZD	4.2	G: ±2%	30	0.028	10000	2200	6
	LQW18AN4N3B8ZD	4.3	B: ±0.1 nH	35	0.036	11600	2100	6
	LQW18AN4N3C8ZD	4.3	C: ±0.2 nH	35	0.036	11600	2100	6
	LQW18AN4N3G8ZD	4.3	G: ±2%	35	0.036	11600	2100	6
	LQW18AN4N7B8ZD	4.7	B: ±0.1 nH	25	0.054	10400	1500	6
	LQW18AN4N7C8ZD	4.7	C: ±0.2 nH	25	0.054	10400	1500	6
	LQW18AN4N7G8ZD	4.7	G: ±2%	25	0.054	10400	1500	6
	LQW18AN4N9B8ZD	4.9	B: ±0.1 nH	23	0.081	7300	1200	6
	LQW18AN4N9C8ZD	4.9	C: ±0.2 nH	23	0.081	7300	1200	6
	LQW18AN4N9G8ZD	4.9	G: ±2%	23	0.081	7300	1200	6
	LQW18AN5N6C8ZD	5.6	C: ±0.2 nH	38	0.040	6650	1900	6
	LQW18AN5N6G8ZD	5.6	G: ±2%	38	0.040	6650	1900	6
	LQW18AN6N0C8ZD	6	C: ±0.2 nH	40	0.040	6650	1900	6
	LQW18AN6N0G8ZD	6	G: ±2%	40	0.040	6650	1900	6
	LQW18AN6N2C8ZD	6.2	C: ±0.2 nH	40	0.040	6650	1900	6
	LQW18AN6N2G8ZD	6.2	G: ±2%	40	0.040	6650	1900	6
	LQW18AN6N5C8ZD	6.5	C: ±0.2 nH	40	0.040	6650	1900	6

Customer Part number	Murata Part number	Inductance		Q (Min.)	DC resistance ( $\Omega$ max.)	Self-resonant frequency (MHz min.)	Rated current (mA)*1	ESD Rank 6: 25 kV
		Nominal value (nH)	Tolerance					
	LQW18AN6N5G8ZD	6.5	G: $\pm 2\%$	40	0.040	6650	1900	6
	LQW18AN6N8C8ZD	6.8	C: $\pm 0.2$ nH	40	0.040	6650	1900	6
	LQW18AN6N8G8ZD	6.8	G: $\pm 2\%$	40	0.040	6650	1900	6
	LQW18AN7N2C8ZD	7.2	C: $\pm 0.2$ nH	38	0.040	6650	1900	6
	LQW18AN7N2G8ZD	7.2	G: $\pm 2\%$	38	0.040	6650	1900	6
	LQW18AN7N5C8ZD	7.5	C: $\pm 0.2$ nH	35	0.048	7000	1500	6
	LQW18AN7N5G8ZD	7.5	G: $\pm 2\%$	35	0.048	7000	1500	6
	LQW18AN8N2C8ZD	8.2	C: $\pm 0.2$ nH	38	0.052	4750	1600	6
	LQW18AN8N2G8ZD	8.2	G: $\pm 2\%$	38	0.052	4750	1600	6
	LQW18AN8N4C8ZD	8.4	C: $\pm 0.2$ nH	38	0.052	4750	1600	6
	LQW18AN8N4G8ZD	8.4	G: $\pm 2\%$	38	0.052	4750	1600	6
	LQW18AN8N7C8ZD	8.7	C: $\pm 0.2$ nH	38	0.052	4750	1600	6
	LQW18AN8N7G8ZD	8.7	G: $\pm 2\%$	38	0.052	4750	1600	6
	LQW18AN9N1C8ZD	9.1	C: $\pm 0.2$ nH	38	0.052	4750	1600	6
	LQW18AN9N1G8ZD	9.1	G: $\pm 2\%$	38	0.052	4750	1600	6
	LQW18AN9N5C8ZD	9.5	C: $\pm 0.2$ nH	38	0.052	4750	1600	6
	LQW18AN9N5G8ZD	9.5	G: $\pm 2\%$	38	0.052	4750	1600	6
	LQW18AN9N9C8ZD	9.9	C: $\pm 0.2$ nH	38	0.052	4750	1600	6
	LQW18AN9N9G8ZD	9.9	G: $\pm 2\%$	38	0.052	4750	1600	6
	LQW18AN10NG8ZD	10	G: $\pm 2\%$	38	0.052	4750	1600	6
	LQW18AN10NJ8ZD	10	J: $\pm 5\%$	38	0.052	4750	1600	6
	LQW18AN11NG8ZD	11	G: $\pm 2\%$	40	0.052	4750	1600	6
	LQW18AN11NJ8ZD	11	J: $\pm 5\%$	40	0.052	4750	1600	6
	LQW18AN12NG8ZD	12	G: $\pm 2\%$	37	0.064	5000	1500	6
	LQW18AN12NJ8ZD	12	J: $\pm 5\%$	37	0.064	5000	1500	6
	LQW18AN13NG8ZD	13	G: $\pm 2\%$	37	0.064	5000	1500	6
	LQW18AN13NJ8ZD	13	J: $\pm 5\%$	37	0.064	5000	1500	6
	LQW18AN15NG8ZD	15	G: $\pm 2\%$	38	0.075	4600	1400	6
	LQW18AN15NJ8ZD	15	J: $\pm 5\%$	38	0.075	4600	1400	6
	LQW18AN16NG8ZD	16	G: $\pm 2\%$	40	0.075	4600	1400	6
	LQW18AN16NJ8ZD	16	J: $\pm 5\%$	40	0.075	4600	1400	6
	LQW18AN17NG8ZD	17	G: $\pm 2\%$	40	0.075	4600	1400	6
	LQW18AN17NJ8ZD	17	J: $\pm 5\%$	40	0.075	4600	1400	6
	LQW18AN18NG8ZD	18	G: $\pm 2\%$	40	0.075	4600	1400	6
	LQW18AN18NJ8ZD	18	J: $\pm 5\%$	40	0.075	4600	1400	6
	LQW18AN19NG8ZD	19	G: $\pm 2\%$	40	0.075	4600	1400	6
	LQW18AN19NJ8ZD	19	J: $\pm 5\%$	40	0.075	4600	1400	6
	LQW18AN22NG8ZD	22	G: $\pm 2\%$	40	0.086	3450	1300	6
	LQW18AN22NJ8ZD	22	J: $\pm 5\%$	40	0.086	3450	1300	6
	LQW18AN23NG8ZD	23	G: $\pm 2\%$	40	0.086	3450	1300	6
	LQW18AN23NJ8ZD	23	J: $\pm 5\%$	40	0.086	3450	1300	6
	LQW18AN24NG8ZD	24	G: $\pm 2\%$	40	0.086	3450	1300	6
	LQW18AN24NJ8ZD	24	J: $\pm 5\%$	40	0.086	3450	1300	6
	LQW18AN25NG8ZD	25	G: $\pm 2\%$	40	0.098	3600	1200	6
	LQW18AN25NJ8ZD	25	J: $\pm 5\%$	40	0.098	3600	1200	6
	LQW18AN27NG8ZD	27	G: $\pm 2\%$	40	0.098	3600	1200	6

Customer Part number	Murata Part number	Inductance		Q (Min.)	DC resistance ( $\Omega$ max.)	Self-resonant frequency (MHz min.)	Rated current (mA)*1	ESD Rank 6: 25 kV
		Nominal value (nH)	Tolerance					
	LQW18AN27NJ8ZD	27	J: $\pm 5\%$	40	0.098	3600	1200	6
	LQW18AN28NG8ZD	28	G: $\pm 2\%$	40	0.098	3600	1200	6
	LQW18AN28NJ8ZD	28	J: $\pm 5\%$	40	0.098	3600	1200	6
	LQW18AN30NG8ZD	30	G: $\pm 2\%$	40	0.12	2880	1100	6
	LQW18AN30NJ8ZD	30	J: $\pm 5\%$	40	0.12	2880	1100	6
	LQW18AN31NG8ZD	31	G: $\pm 2\%$	40	0.11	3150	1100	6
	LQW18AN31NJ8ZD	31	J: $\pm 5\%$	40	0.11	3150	1100	6
	LQW18AN33NG8ZD	33	G: $\pm 2\%$	40	0.11	3150	1100	6
	LQW18AN33NJ8ZD	33	J: $\pm 5\%$	40	0.11	3150	1100	6
	LQW18AN34NG8ZD	34	G: $\pm 2\%$	40	0.15	3000	1050	6
	LQW18AN34NJ8ZD	34	J: $\pm 5\%$	40	0.15	3000	1050	6
	LQW18AN36NG8ZD	36	G: $\pm 2\%$	37	0.20	3000	910	6
	LQW18AN36NJ8ZD	36	J: $\pm 5\%$	37	0.20	3000	910	6
	LQW18AN37NG8ZD	37	G: $\pm 2\%$	37	0.20	3000	910	6
	LQW18AN37NJ8ZD	37	J: $\pm 5\%$	37	0.20	3000	910	6
	LQW18AN39NG8ZD	39	G: $\pm 2\%$	40	0.16	3280	1000	6
	LQW18AN39NJ8ZD	39	J: $\pm 5\%$	40	0.16	3280	1000	6
	LQW18AN41NG8ZD	41	G: $\pm 2\%$	40	0.16	3280	1000	6
	LQW18AN41NJ8ZD	41	J: $\pm 5\%$	40	0.16	3280	1000	6
	LQW18AN43NG8ZD	43	G: $\pm 2\%$	40	0.21	2780	840	6
	LQW18AN43NJ8ZD	43	J: $\pm 5\%$	40	0.21	2780	840	6
	LQW18AN44NG8ZD	44	G: $\pm 2\%$	40	0.21	2780	840	6
	LQW18AN44NJ8ZD	44	J: $\pm 5\%$	40	0.21	2780	840	6
	LQW18AN47NG8ZD	47	G: $\pm 2\%$	32	0.23	2700	830	6
	LQW18AN47NJ8ZD	47	J: $\pm 5\%$	32	0.23	2700	830	6
	LQW18AN48NG8ZD	48	G: $\pm 2\%$	32	0.23	2700	830	6
	LQW18AN48NJ8ZD	48	J: $\pm 5\%$	32	0.23	2700	830	6
	LQW18AN51NG8ZD	51	G: $\pm 2\%$	32	0.23	2700	830	6
	LQW18AN51NJ8ZD	51	J: $\pm 5\%$	32	0.23	2700	830	6
	LQW18AN52NG8ZD	52	G: $\pm 2\%$	35	0.27	2750	750	6
	LQW18AN52NJ8ZD	52	J: $\pm 5\%$	35	0.27	2750	750	6
	LQW18AN56NG8ZD	56	G: $\pm 2\%$	38	0.26	2600	770	6
	LQW18AN56NJ8ZD	56	J: $\pm 5\%$	38	0.26	2600	770	6
	LQW18AN58NG8ZD	58	G: $\pm 2\%$	35	0.30	2400	700	6
	LQW18AN58NJ8ZD	58	J: $\pm 5\%$	35	0.30	2400	700	6
	LQW18AN68NG8ZD	68	G: $\pm 2\%$	37	0.38	2380	630	6
	LQW18AN68NJ8ZD	68	J: $\pm 5\%$	37	0.38	2380	630	6
	LQW18AN69NG8ZD	69	G: $\pm 2\%$	37	0.38	2380	630	6
	LQW18AN69NJ8ZD	69	J: $\pm 5\%$	37	0.38	2380	630	6
	LQW18AN72NG8ZD	72	G: $\pm 2\%$	34	0.47	2330	560	6
	LQW18AN72NJ8ZD	72	J: $\pm 5\%$	34	0.47	2330	560	6
	LQW18AN73NG8ZD	73	G: $\pm 2\%$	28	0.41	2280	590	6
	LQW18AN73NJ8ZD	73	J: $\pm 5\%$	28	0.41	2280	590	6
	LQW18AN75NG8ZD	75	G: $\pm 2\%$	28	0.41	2280	590	6
	LQW18AN75NJ8ZD	75	J: $\pm 5\%$	28	0.41	2280	590	6
	LQW18AN78NG8ZD	78	G: $\pm 2\%$	28	0.41	2280	590	6

Customer Part number	Murata Part number	Inductance		Q (Min.)	DC resistance ( $\Omega$ max.)	Self-resonant frequency (MHz min.)	Rated current (mA)*1	ESD Rank 6: 25 kV
		Nominal value (nH)	Tolerance					
	LQW18AN78NJ8ZD	78	J: $\pm 5\%$	28	0.41	2280	590	6
	LQW18AN82NG8ZD	82	G: $\pm 2\%$	34	0.5	2230	550	6
	LQW18AN82NJ8ZD	82	J: $\pm 5\%$	34	0.5	2230	550	6
	LQW18AN83NG8ZD	83	G: $\pm 2\%$	34	0.5	2230	550	6
	LQW18AN83NJ8ZD	83	J: $\pm 5\%$	34	0.5	2230	550	6
	LQW18AN91NG8ZD	91	G: $\pm 2\%$	33	0.54	1900	520	6
	LQW18AN91NJ8ZD	91	J: $\pm 5\%$	33	0.54	1900	520	6
	LQW18AN94NG8ZD	94	G: $\pm 2\%$	34	0.63	1750	490	6
	LQW18AN94NJ8ZD	94	J: $\pm 5\%$	34	0.63	1750	490	6
	LQW18ANR10G8ZD	100	G: $\pm 2\%$	34	0.63	1750	490	6
	LQW18ANR10J8ZD	100	J: $\pm 5\%$	34	0.63	1750	490	6
	LQW18ANR11G8ZD	110	G: $\pm 2\%$	32	0.7	1730	450	6
	LQW18ANR11J8ZD	110	J: $\pm 5\%$	32	0.7	1730	450	6
	LQW18ANR12G8ZD	120	G: $\pm 2\%$	32	0.72	1650	450	6
	LQW18ANR12J8ZD	120	J: $\pm 5\%$	32	0.72	1650	450	6
	LQW18ANR15G8ZD	150	G: $\pm 2\%$	28	0.87	1580	420	6
	LQW18ANR15J8ZD	150	J: $\pm 5\%$	28	0.87	1580	420	6
	LQW18ANR18G8ZD	180	G: $\pm 2\%$	25	1.65	1380	310	6
	LQW18ANR18J8ZD	180	J: $\pm 5\%$	25	1.65	1380	310	6
	LQW18ANR20G8ZD	200	G: $\pm 2\%$	25	1.74	1350	290	6
	LQW18ANR20J8ZD	200	J: $\pm 5\%$	25	1.74	1350	290	6
	LQW18ANR21G8ZD	210	G: $\pm 2\%$	27	1.98	1330	280	6
	LQW18ANR21J8ZD	210	J: $\pm 5\%$	27	1.98	1330	280	6
	LQW18ANR22G8ZD	220	G: $\pm 2\%$	25	2.08	1330	280	6
	LQW18ANR22J8ZD	220	J: $\pm 5\%$	25	2.08	1330	280	6
	LQW18ANR25G8ZD	250	G: $\pm 2\%$	24	2.28	1330	250	6
	LQW18ANR25J8ZD	250	J: $\pm 5\%$	24	2.28	1330	250	6
	LQW18ANR27G8ZD	270	G: $\pm 2\%$	24	2.42	1250	260	6
	LQW18ANR27J8ZD	270	J: $\pm 5\%$	24	2.42	1250	260	6
	LQW18ANR30G8ZD	300	G: $\pm 2\%$	25	3.12	1200	220	6
	LQW18ANR30J8ZD	300	J: $\pm 5\%$	25	3.12	1200	220	6
	LQW18ANR33G8ZD	330	G: $\pm 2\%$	25	3.84	1100	190	6
	LQW18ANR33J8ZD	330	J: $\pm 5\%$	25	3.84	1100	190	6
	LQW18ANR36G8ZD	360	G: $\pm 2\%$	25	3.98	1050	190	6
	LQW18ANR36J8ZD	360	J: $\pm 5\%$	25	3.98	1050	190	6
	LQW18ANR39G8ZD	390	G: $\pm 2\%$	25	4.23	1100	190	6
	LQW18ANR39J8ZD	390	J: $\pm 5\%$	25	4.23	1100	190	6

\*1 As shown in the diagram below, derating is applied to the rated current based on the operating temperature.

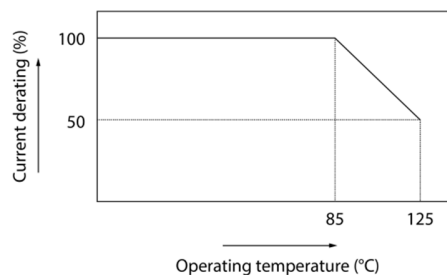

**4. Testing Conditions**

Unless otherwise specified	Temperature: ordinary temperature (15°C to 35°C) Humidity: ordinary humidity [25% to 85% (RH)]
In case of doubt	Temperature: 20°C±2°C Humidity: 60% to 70% (RH) Atmospheric pressure: 86 kPa to 106 kPa

**5. Appearance and Dimensions**

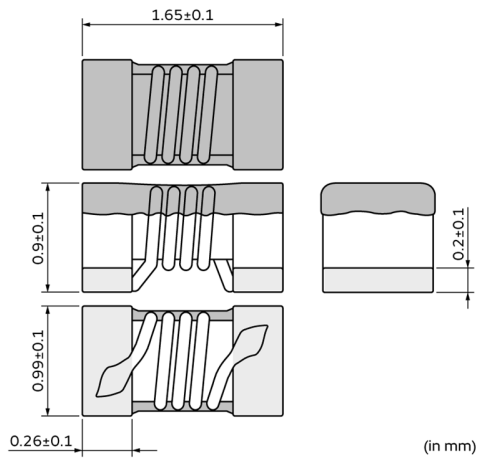

Unit mass (typical value): 0.0034 g

**6. Marking**

No marking.

## 7. Electrical Performance

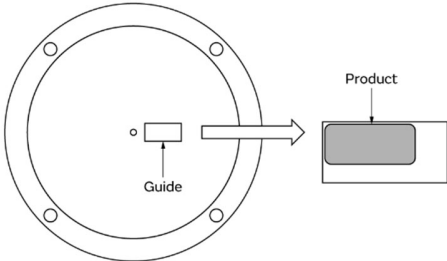
No.	Item	Specification	Test method												
7.1	Inductance	Meet chapter 3 ratings.	Measuring equipment: Keysight E4991A or the equivalent Measuring frequency: <table border="1" data-bbox="917 362 1422 539"> <tr> <td>Inductance</td> <td colspan="2">100 MHz</td> </tr> <tr> <td rowspan="4">Q</td> <td>250 MHz</td> <td>2.2 nH to 44 nH</td> </tr> <tr> <td>200 MHz</td> <td>47 nH to 69 nH</td> </tr> <tr> <td>150 MHz</td> <td>72 nH to 150 nH</td> </tr> <tr> <td>100 MHz</td> <td>180 nH to 390 nH</td> </tr> </table> Measuring conditions: Measurement signal level: Approx. 0 dBm Measurement terminal distance: 1.0 mm Electrical length: 10.0 mm Measuring fixture: Keysight 16197A Position the chip coil under test as shown in the measuring example below and connect it to the electrode by applying weight. Measurement example:  Measuring method: see "Electrical performance: Measuring method for inductance/Q" in the chapter "15. Appendix".	Inductance	100 MHz		Q	250 MHz	2.2 nH to 44 nH	200 MHz	47 nH to 69 nH	150 MHz	72 nH to 150 nH	100 MHz	180 nH to 390 nH
Inductance	100 MHz														
Q	250 MHz	2.2 nH to 44 nH													
	200 MHz	47 nH to 69 nH													
	150 MHz	72 nH to 150 nH													
	100 MHz	180 nH to 390 nH													
7.2	Q	Meet chapter 3 ratings.													
7.3	DC resistance	Meet chapter 3 ratings.	Measuring equipment: digital multimeter												
7.4	Self-resonant frequency	Meet chapter 3 ratings.	Measuring equipment: Keysight N5230A or the equivalent												
7.5	Rated current	Product temperature rise: 40°C max.	Apply the rated current specified in chapter 3.												

## 8. AEC-Q200 Requirement

## 8.1 Performance [based on table 5 for magnetics (inductors/transformer) AEC-Q200 Rev. D issued June 1, 2010]

AEC-Q200			Murata specification/deviation				
No.	Stress	Test method					
3	High temperature exposure	1000 h at 125°C Set for 24 h at room condition, then measured.	Meet table A after testing. Table A <table border="1" data-bbox="885 1659 1468 1731"> <tr> <td>Appearance</td> <td>No damage</td> </tr> <tr> <td>Inductance change rate (at 100 MHz)</td> <td>Within ±5%</td> </tr> </table>	Appearance	No damage	Inductance change rate (at 100 MHz)	Within ±5%
Appearance	No damage						
Inductance change rate (at 100 MHz)	Within ±5%						
4	Temperature cycling	1000 cycles -40°C to +125°C Set for 24 h at room condition, then measured.	Meet table A after testing.				
7	Biased humidity	1000 h at 85°C, 85% (RH). Unpowered. Set for 24 h at room condition, then measured.	Meet table A after testing.				
8	Operational life	Apply rated current 125°C 1000 h Set for 24 h at room condition, then measured.	Meet table A after testing.				

AEC-Q200			Murata specification/deviation				
No.	Stress	Test method					
9	External visual	Visual inspection	No abnormalities				
10	Physical dimension	Meet chapter 5, "Appearance and Dimensions".	No defects				
12	Resistance to solvents	Per MIL-STD-202 Method 215	Not applicable				
13	Mechanical shock	Per MIL-STD-202 Method 213 Condition C: 100 g's (0.98 N), 6 ms, half sine, 12.3 ft/s	Meet table A after testing.				
14	Vibration	5 g's (0.049 N) for 20 min, 12 cycles each of 3 orientations Test from 10 Hz to 2000 Hz	Meet table A after testing.				
15	Resistance to soldering heat	No-heating Solder temperature 260°C±5°C Immersion time 10 s	Pre-heating: 150°C±10°C, 60 s to 90 s Meet table A after testing.				
17	ESD	Per AEC-Q200-002	ESD rank: Refer to chapter 3 ratings. Meet table A after testing.				
18	Solderability	Per J-STD-002	Method b: not applicable 95% of the terminations is to be soldered (except exposed wire).				
19	Electrical characterization	Measured: inductance	No defects				
20	Flammability	Per UL-94	Not applicable				
21	Board flex	Epoxy-PCB (1.6 mm) Deflection 2 mm (min.) Holding time 60 s	Meet table B after testing. Table B <table border="1" style="margin-left: 20px;"> <tr> <td>Appearance</td> <td>No damage</td> </tr> <tr> <td>DC resistance change rate</td> <td>Within ±10%</td> </tr> </table>	Appearance	No damage	DC resistance change rate	Within ±10%
Appearance	No damage						
DC resistance change rate	Within ±10%						
22	Terminal Strength	Per AEC-Q200-006 A force of 17.7 N for 60 s	Murata deviation request: 10 N for 5 s No defect				

## 9. Specification of Packaging

### 9.1 Appearance and dimensions of tape (8 mm width/paper tape)

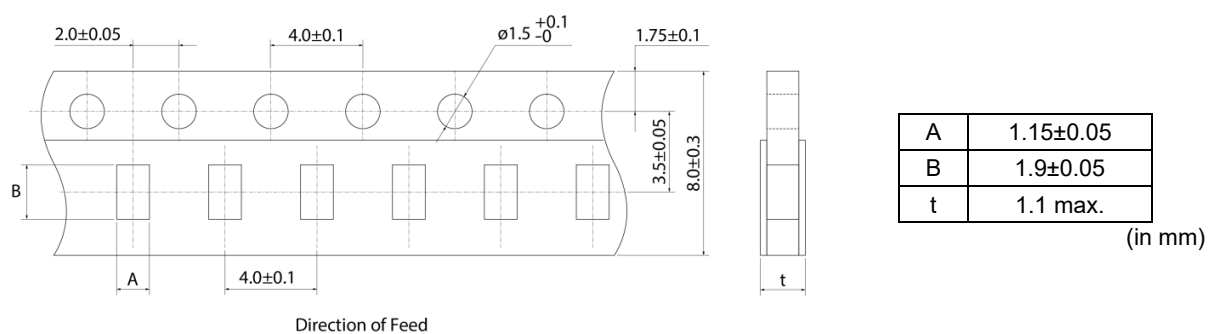

### 9.2 Taping specifications

Packing quantity (Standard quantity)	4000 pcs/reel
Packing method	The products are placed in embossed cavities of a base tape and sealed by a top tape and a bottom tape.
Feed hole position	The feed holes on the base tape are on the right side when the top tape is pulled toward the user.
Joint	The base tape and the top tape are seamless.
Number of missing products	Number of missing products within 0.025% of the number per reel or 1 pc., whichever is greater, and are not continuous. The specified quantity per reel is kept.

**9.3 Break down force of tape**

Break down force of top tape	5 N min.
Break down force of bottom tape	5 N min.

**9.4 Peeling off force of top tape**

Speed of peeling off	300 mm/min
Peeling off force	0.1 N to 0.6 N (The lower limit is for typical value.)

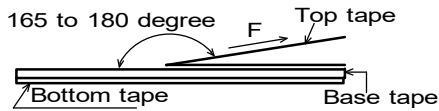

**9.5 Dimensions of leader section, trailer section and reel**

A vacant section is provided in the leader (start) section and trailer (end) section of the tape for the product. The leader section is further provided with an area consisting only of the cover tape (or top tape). (See the diagram below.)

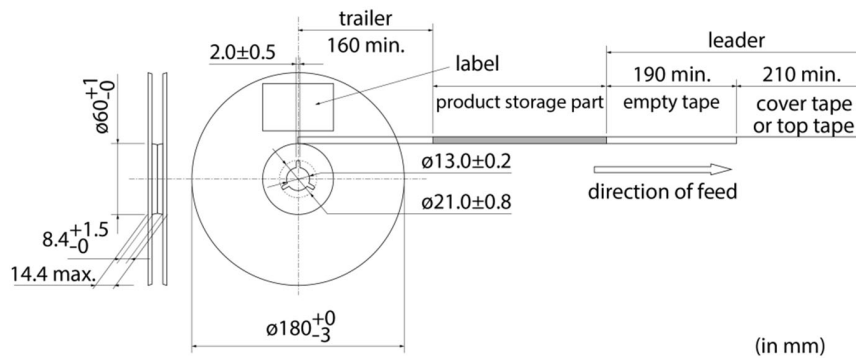

(in mm)

**9.6 Marking for reel**

Customer part number, Murata part number, inspection number (\*1), RoHS marking (\*2), quantity, etc.

<p>*1 Expression of inspection No.:</p> <p style="text-align: center;">□□    ○○○○    ◇◇◇◇</p> <p style="text-align: center;">(1)        (2)        (3)</p>	<p>(1) Factory code</p> <p>(2) Date</p> <p style="padding-left: 20px;">First digit: year/last digit of year</p> <p style="padding-left: 20px;">Second digit: month/Jan. to Sep.→1 to 9, Oct. to Dec.→O, N, D</p> <p style="padding-left: 20px;">Third, Fourth digit: day</p> <p>(3) Serial No.</p>
<p>*2 Expression of RoHS marking:</p> <p style="text-align: center;">ROHS-    Y    (△)</p> <p style="text-align: center;">(1)        (2)</p>	<p>(1) RoHS regulation conformity</p> <p>(2) Murata classification number</p>

**9.7 Marking on outer box (corrugated box)**

Customer name, purchasing order number, customer part number, Murata part number, RoHS marking (\*2), quantity, etc.

**9.8 Specification of outer box**

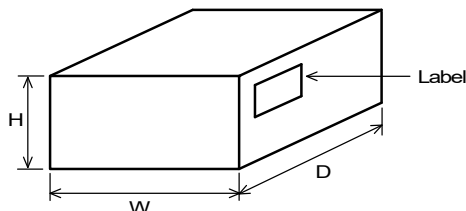

Dimensions of outer box (mm)			Standard reel quantity in outer box (reel)
W	D	H	
186	186	93	5
* Above outer box size is typical. It depends on a quantity of an order.			

**10. ⚠Caution****10.1 Restricted applications**

Please contact us before using our products for the applications listed below which require especially high reliability for the prevention of defects which might directly cause damage to the third party's life, body or property.

- |                                   |   |
|-----------------------------------|---|
| (1) Aircraft equipment            | (6) Disaster/crime prevention equipment   |
| (2) Aerospace equipment           | (7) Traffic signal equipment  |
| (3) Undersea equipment            | (8) Transportation equipment (trains, ships, etc.)  |
| (4) Power plant control equipment | (9) Data-processing equipment   |
| (5) Medical equipment             | (10) Applications of similar complexity and/or reliability requirements to the applications listed in the above |

**10.2 Precautions on rating**

Do not use the products in excess of their rated current. Doing so may cause the product to generate heat, resulting in short circuit between wires, wire breakage, or melted solder, which may cause dropping of parts.

**10.3 Fail-safe**

Be sure to provide an appropriate fail-safe function on your product to prevent a second damage that may be caused by the abnormal function or the failure of our product.

**10.4 Corrosive gas**

Please refrain from use since contact with environments with corrosive gases (sulfur gas [hydrogen sulfide, sulfur dioxide, etc.], chlorine, ammonia, etc.) or oils (cutting oil, silicone oil, etc.) that have come into contact with the previously stated corrosive gas environment will result in deterioration of product quality or an open from deterioration due to corrosion of product electrode, etc. We will not bear any responsibility for use under these environments.

**11. Precautions for Use**

This product is for use only with reflow soldering. It is designed to be mounted by soldering. If you want to use other mounting method, for example, using a conductive adhesive, please consult us beforehand.

Also, if repeatedly subjected to temperature cycles or other thermal stress, due to the difference in the coefficient of thermal expansion with the mounting substrate, the solder (solder fillet part) in the mounting part may crack.

The occurrence of cracks due to thermal stress is affected by the size of the land where mounted, the solder volume, and the heat dissipation of the mounting substrate. Carefully design it when a large change in ambient temperature is assumed.

**11.1 Land dimensions**

The following diagram shows the recommended land dimensions for reflow soldering.

The land dimensions are designed in consideration of electrical characteristics and mountability. Use of other land dimensions may preclude achievement of performance. In some cases, it may result in poor solderability, including positional shift. If you use other land pattern, consider it adequately.

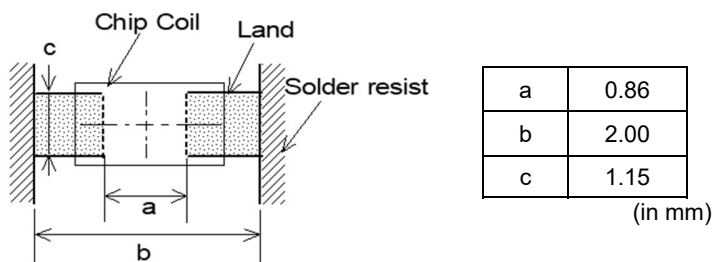
**11.2 Flux and solder used**

Flux	<ul style="list-style-type: none"> <li>• Use a rosin-based flux that includes an activator with a chlorine conversion value of 0.06(wt)% to 0.1(wt)%.</li> <li>• Do not use a highly acidic flux with a halide content exceeding 0.2(wt)% (chlorine conversion value).</li> <li>• Do not use a water-soluble flux.</li> </ul>
Solder	<ul style="list-style-type: none"> <li>• Use Sn-3.0Ag-0.5Cu solder.</li> <li>• Standard thickness of solder paste: 100 μm to 150 μm</li> </ul>

If you want to use a flux other than the above, please consult our technical department.

**11.3 Soldering conditions (reflow)**

- Pre-heating should be in such a way that the temperature difference between solder and product surface is limited to 150°C max.  
Cooling into solvent after soldering also should be in such a way that the temperature difference is limited to 100°C max. Insufficient pre-heating may cause cracks on the product, resulting in the deterioration of product quality.
- Standard soldering profile and the limit soldering profile is as follows.  
The excessive limit soldering conditions may cause leaching of the electrode and/or resulting in the deterioration of product quality.



	Standard profile	Limit profile
Pre-heating	150°C to 180°C/90 s±30 s	150°C to 180°C/90 s±30 s
Heating	Above 220°C/30 s to 60 s	Above 230°C/60 s max.
Peak temperature	245°C±3°C	260°C/10 s
Number of reflow cycles	2 times	2 times

**11.4 Reworking with soldering iron**

The following requirements must be met to rework a soldered product using a soldering iron.

Item	Requirement
Pre-heating	150°C/approx. 1 min
Tip temperature of soldering iron	350°C max.
Power consumption of soldering iron	80 W max.
Tip diameter of soldering iron	ø3 mm max.
Soldering time	3 s (+1 s, -0 s)
Number of reworking operations	2 times max.
* Avoid a direct contact of the tip of the soldering iron with the product. Such a direction contact may cause cracks in the ceramic body due to thermal shock.	

**11.5 Solder volume**

Solder shall be used not to increase the volume too much.

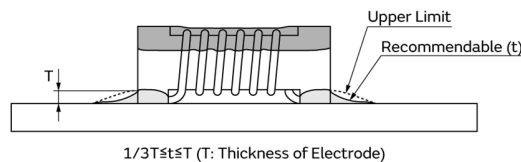

An increased solder volume increases mechanical stress on the product. Exceeding solder volume may cause the failure of mechanical or electrical performance.

**11.6 Product's location**

The following shall be considered when designing and laying out PCBs.

(1) PCB shall be designed so that products are not subject to mechanical stress due to warping the board.

[Products direction]

Products shall be located in the sideways direction (length:  $a < b$ ) to the mechanical stress.

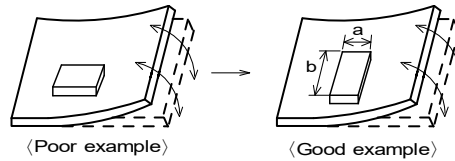

(2) Components location on PCB separation

It is effective to implement the following measures, to reduce stress in separating the board.

It is best to implement all of the following three measures; however, implement as many measures as possible to reduce stress.

Contents of measures	Stress level
(1) Turn the mounting direction of the component parallel to the board separation surface.	$A > D^{*1}$
(2) Add slits in the board separation part.	$A > B$
(3) Keep the mounting position of the component away from the board separation surface.	$A > C$
*1 $A > D$ is valid when stress is added vertically to the perforation as with hand separation. If a cutting disc is used, stress will be diagonal to the PCB, therefore $A > D$ is invalid.	

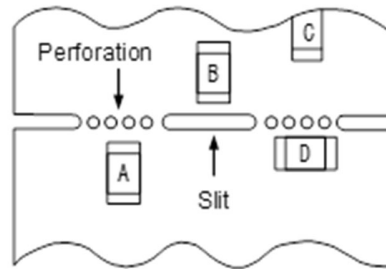

(3) Mounting components near screw holes

When a component is mounted near a screw hole, it may be affected by the board deflection that occurs during the tightening of the screw.

Mount the component in a position as far away from the screw holes as possible.

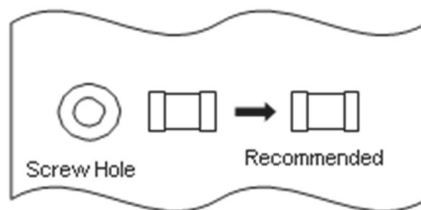

**11.7 Handling of substrate**

After mounting products on a substrate, do not apply any stress to the product caused by bending or twisting to the substrate when cropping the substrate, inserting and removing a connector from the substrate or tightening screw to the substrate. Excessive mechanical stress may cause cracking in the product.

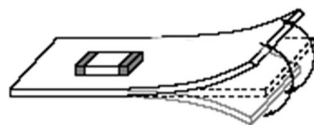

Bending

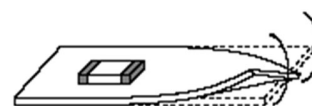

Twisting

**11.8 Cleaning**

The product shall be cleaned under the following conditions.

- (1) The cleaning temperature shall be 60°C max. If isopropyl alcohol (IPA) is used, the cleaning temperature shall be 40°C max.
- (2) Perform ultrasonic cleaning under the following conditions. Exercise caution to prevent resonance phenomenon in mounted products and the PCB.

Item	Requirement
Power	20 W/L max.
Time	5 min max.
Frequency	28 kHz to 40 kHz

- (3) Cleaner

Alcohol-based cleaner: IPA

Aqueous agent: PINE ALPHA ST-100S

- (4) There shall be no residual flux or residual cleaner. When using aqueous agent, rinse the product with deionized water adequately and completely dry it so that no cleaner is left.

\* For other cleaning, consult our technical department.

**11.9 Storage and transportation**

Storage period	Use the product within 12 months after delivery. If you do not use the product for more than 12 months, check solderability before using it.
Storage conditions	<ul style="list-style-type: none"> <li>• The products shall be stored in a room not subject to rapid changes in temperature and humidity. The recommended temperature range is -10°C to +40°C. The recommended relative humidity range is 15% to 85%. Keeping the product in corrosive gases, such as sulfur, chlorine gas or acid, oxidizes the electrode, resulting in poor solderability or corrosion of the coil wire of the product.</li> <li>• Do not keep products in bulk packaging. Doing so may cause collision between the products or between the products and other products, resulting in core chipping or wire breakage.</li> <li>• Do not place the products directly on the floor; they should be placed on a palette so that they are not affected by humidity or dust.</li> <li>• Avoid keeping the products in a place exposed to direct sunlight, heat or vibration.</li> </ul>
Transportation	Excessive vibration and impact reduces the reliability of the products. Exercise caution when handling the products.

**11.10 Resin coating**

The inductance value may change due to high cure-stress of resin to be used for coating/molding products.

A wire breakage issue may occur by mechanical stress caused by the resin, amount/cured shape of resin, or operating condition etc. Some resin contains some impurities or chloride possible to generate chlorine by hydrolysis under some operating condition may cause corrosion of wire of coil, leading to wire breakage.

So, please pay your careful attention when you select resin in case of coating/molding the products with the resin.

Prior to use the coating resin, please make sure no reliability issue is observed by evaluating products mounted on your board.

**11.11 Handling of product**

- Sharp material such as a pair of tweezers or other material such as bristles of cleaning brush, shall not be touched to the winding portion to prevent the breaking of wire.
- Mechanical shock should not be applied to the products mounted on the board to prevent the breaking of the core.

**11.12 Handling with mounting equipment**

- With some types of mounting equipment, a support pin pushes up the product from the bottom of the base (paper) tape when the product is sucked with the pick-up nozzle.  
When using this type of equipment, detach the support pin to prevent the breaking of wire on the product.
- In some cases, the laser recognition function of the mounting equipment may not recognize this product correctly. Please contact us when using laser recognition. (There is no problem with the permeation and reflection type.)

**12.  Note**

- (1) Please make sure that your product has been evaluated in view of your specifications with our product being mounted to your product.
- (2) You are requested not to use our product deviating from the reference specifications.
- (3) The contents of this reference specification are subject to change without advance notice. Please approve our product specifications or transact the approval sheet for product specifications before ordering.

**13. Appendix**

Electrical performance: Measuring method for inductance/Q (Q measurement is applicable only when the Q value is included in the rating table.)

Perform measurement using the method described below. (Perform correction for the error deriving from the measuring terminal.)

(1) Residual elements and stray elements of the measuring terminal can be expressed by the F parameter for the 2-pole terminal as shown in the figure below.

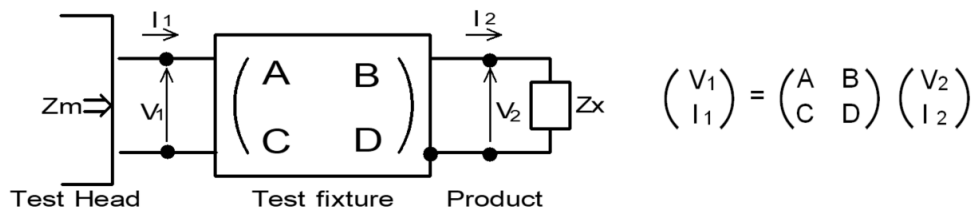

(2) The product's impedance value ( $Z_x$ ) and measured impedance value ( $Z_m$ ) can be expressed as shown below, by using the respective current and voltage for input/output.

$$Z_m = \frac{V_1}{I_1} \quad Z_x = \frac{V_2}{I_2}$$

(3) Thus, the relationship between the product's impedance value ( $Z_x$ ) and measured impedance value ( $Z_m$ ) is as follows.

$Z_x = \alpha \frac{Z_m - \beta}{1 - Z_m \Gamma}$	<p>Here,</p> <p><math>\alpha = D/A = 1</math></p> <p><math>\beta = B/D = Z_{sm} - (1 - Y_{om} Z_{sm}) Z_{ss}</math></p> <p><math>\Gamma = C/A = Y_{om}</math></p> <p><math>Z_{sm}</math>: measured impedance of short chip</p> <p><math>Z_{ss}</math>: residual impedance of short chip (0.771 nH)</p> <p><math>Y_{om}</math>: measured admittance when measuring terminal is open</p>
---	--

(4) Calculate inductance  $L_x$  and  $Q_x$  using the equations shown below.

$L_x = \frac{\text{Im}(Z_x)}{2\pi f}$	<p><math>L_x</math>: inductance of chip coil</p> <p><math>Q_x</math>: Q of chip coil</p> <p><math>f</math>: measuring frequency</p>
$Q_x = \frac{\text{Im}(Z_x)}{\text{Re}(Z_x)}$	

# Mouser Electronics

Authorized Distributor

Click to View Pricing, Inventory, Delivery & Lifecycle Information:

[Murata:](#)

[LQW18AN75NJ8ZD](#) [LQW18ANR22J8ZD](#) [LQW18AN6N2G8ZD](#) [LQW18AN6N2C8ZD](#)