

# LQH2MPZ6R8MGR#

“#” indicates a package specification code.

0806(inch) / 2016(mm) size, 0.95 mm max height, low DC resistance inductor.



< List of part numbers with package codes >  
LQH2MPZ6R8MGRL

## Appearance & Shape

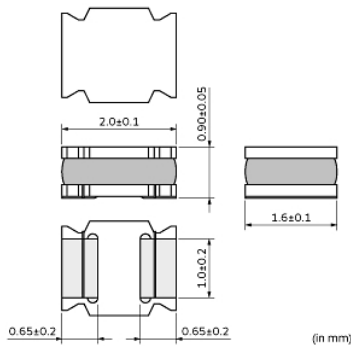
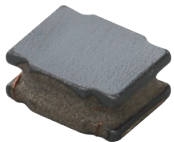

## Notices

When rated current is applied to the products, inductance will be within  $\pm 30\%$  of initial inductance value range. Keep the temperature (ambient temperature plus self-generation of heat) under  $125^{\circ}\text{C}$ . When rated current is applied to the products, temperature rise caused by self-generated heat shall be limited to  $40^{\circ}\text{C}$  max (ambient temperature  $85^{\circ}\text{C}$  max). When rated current is applied to the products, temperature rise caused by self-generated heat shall be limited to  $20^{\circ}\text{C}$  max (ambient temperature  $85^{\circ}\text{C}$  to  $105^{\circ}\text{C}$ ).

## References

Packaging	Specifications	Standard Packing Quantity
L	180Embossed Tape	3000

Mass (typ.)	
1 piece	0.01g

### Attention

- 1.This datasheet is downloaded from the website of Murata Manufacturing Co., Ltd. Therefore, it's specifications are subject to change or our products in it may be discontinued without advance notice. Please check with our sales representatives or product engineers before ordering.
- 2.This datasheet has only typical specifications because there is no space for detailed specifications. Therefore, please review our product specifications or consult the approval sheet for product specifications before ordering.

# LQH2MPZ6R8MGR#

“#” indicates a package specification code.



## Specifications

L size	2.0±0.1mm
W size	1.6±0.1mm
T size	0.9±0.05mm
Size code inch (mm)	0806 (2016)
Inductance	6.8μH±20%
Inductance Test Frequency	1MHz
Rated current (Isat) (Based on Inductance change)	730mA
Rated current (Itemp) (Based on Temperature rise)	530mA(Ambient temp.85°C) 310mA(Ambient temp.105°C)
Max. of DC resistance	0.864Ω
Operating Temperature Range (Self-temperature rise is included)	-40°C to 125°C
Class of magnetic shield	Ferrite Core
Self resonance frequency (min.)	35MHz
Operating Temperature Range(Self-temperature rise is not included)	-40°C to 105°C
Brand	Murata
DC Resistance Intermediate Values	0.72Ω±20%
Series	LQH2MPZ_GR

### Attention

- 1.This datasheet is downloaded from the website of Murata Manufacturing Co., Ltd. Therefore, it's specifications are subject to change or our products in it may be discontinued without advance notice. Please check with our sales representatives or product engineers before ordering.
- 2.This datasheet has only typical specifications because there is no space for detailed specifications. Therefore, please review our product specifications or consult the approval sheet for product specifications before ordering.

# LQH2MPZ6R8MGR#

"#" indicates a package specification code.



## Characteristic Data

The charts below may show another part number which shares its characteristics.

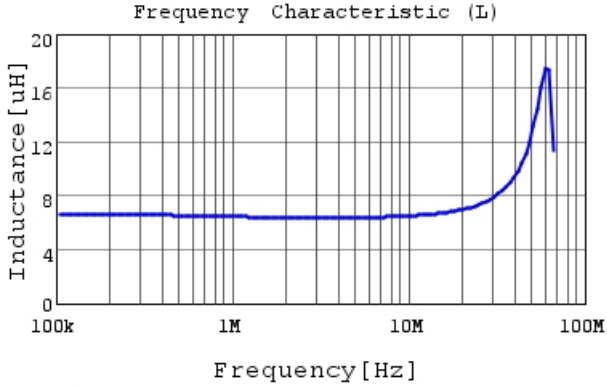

LQH2MPZ6R8MGR L

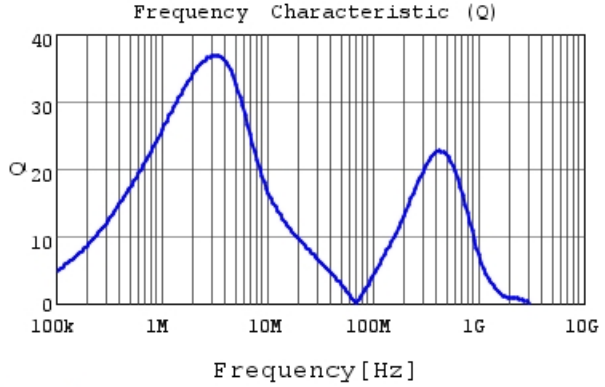

LQH2MPZ6R8MGR Q

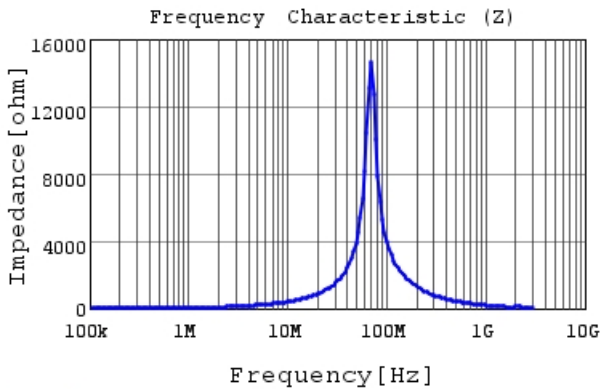

LQH2MPZ6R8MGR |Z|

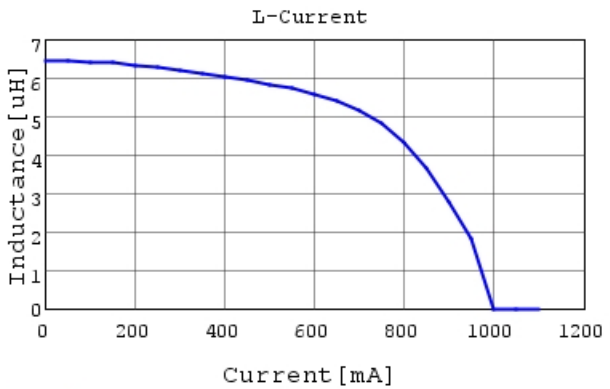

LQH2MPZ6R8MGR L-Current 20degC

**Attention**

- 1.This datasheet is downloaded from the website of Murata Manufacturing Co., Ltd. Therefore, it's specifications are subject to change or our products in it may be discontinued without advance notice. Please check with our sales representatives or product engineers before ordering.
- 2.This datasheet has only typical specifications because there is no space for detailed specifications. Therefore, please review our product specifications or consult the approval sheet for product specifications before ordering.

# LQH2MPZ6R8MGR#

“#” indicates a package specification code.

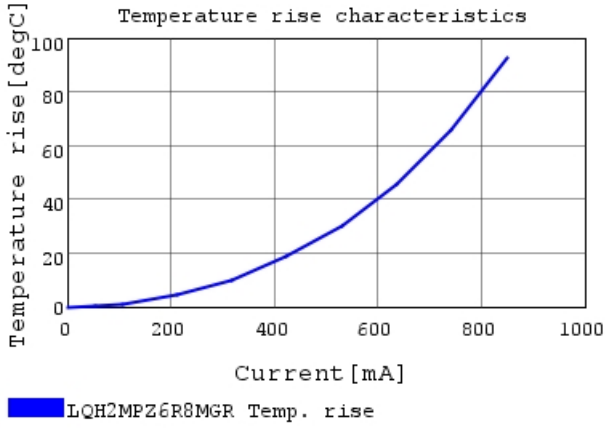

**Attention**

- 1.This datasheet is downloaded from the website of Murata Manufacturing Co., Ltd. Therefore, it's specifications are subject to change or our products in it may be discontinued without advance notice. Please check with our sales representatives or product engineers before ordering.
- 2.This datasheet has only typical specifications because there is no space for detailed specifications. Therefore, please review our product specifications or consult the approval sheet for product specifications before ordering.