



Highbright 0603 ChipLED



DESCRIPTION

The new ChipLED series have been designed in the smallest SMD package. This innovative ChipLED technology opens the way to

- smaller products of higher performance
- more design-in flexibility
- enhanced applications

The 0603 LED is an obvious solution for small-scale, high brightness products that are expected to work reliably in an arduous environment.

PRODUCT GROUP AND PACKAGE DATA

- Product group: LED
- Package: SMD 0603 ChipLED
- Product series: power
- Angle of half intensity: $\pm 73^\circ$

FEATURES

- Super thin ChipLED with exceptional brightness 1.6 mm x 0.8 mm x 0.55 mm (L x W x H)
- High reliability PCB based
- Wavelength typ. 525 nm (true green)
- InGaN technology
- Viewing angle: extremely wide 146°
- Grouping parameter: luminous intensity, dominant wavelength, and forward voltage
- Available in 8 mm tape on 7" diameter reel
- Compatible to IR reflow soldering
- Preconditioning according to JEDEC® level 2a
- Material categorization: for definitions of compliance please see www.vishay.com/doc?99912



APPLICATIONS

- Wearables
- Backlight keypads
- Navigation systems
- Cellular phone displays
- Displays for industrial control systems
- Miniaturized color effects
- Traffic displays
- Heart rate monitoring

PARTS TABLE														
PART	COLOR	LUMINOUS INTENSITY (mcd)			at I _F (mA)	WAVELENGTH (nm)			at I _F (mA)	FORWARD VOLTAGE (V)			at I _F (mA)	TECHNOLOGY
		MIN.	TYP.	MAX.		MIN.	TYP.	MAX.		MIN.	TYP.	MAX.		
VLMTG1400-GS08	True green	1200	1400	2800	20	515	525	535	20	2.45	2.80	3.05	20	InGaN
VLMTG1401-GS08	True green	1200	1400	2800	20	515	525	535	20	2.60	2.80	3.05	20	InGaN
VLMTG1402-GS08	True green	1200	1400	2800	20	520	527	535	20	2.45	2.80	3.05	20	InGaN

ABSOLUTE MAXIMUM RATINGS (T _{amb} = 25 °C, unless otherwise specified) VLMTG1400, VLMTG1401 (InGaN technology)				
PARAMETER	TEST CONDITION	SYMBOL	VALUE	UNIT
DC forward current		I _F	20	mA
Surge forward current	1/10 duty cycle, 0.1 ms pulse width	I _{FSM}	100	mA
Power dissipation	T _{amb} ≤ 25 °C	P _V	64	mW
Operating temperature range		T _{amb}	-40 to +80	°C
Storage temperature range		T _{stg}	-40 to +100	°C
IREL solder conditions	According Vishay specifications	T _{st}	260	°C
Thermal resistance junction-to-ambient	Mounted on PCB (pad size > 5 mm ²)	R _{thJA}	550	K/W
ESD rating	HBM, CDM, MM	V _{ESD}	300, 500, 50	V



OPTICAL AND ELECTRICAL CHARACTERISTICS ($T_{amb} = 25\text{ }^{\circ}\text{C}$, unless otherwise specified) VLMTG1400, VLMTG1401, TRUE GREEN							
PARAMETER	TEST CONDITION	PART	SYMBOL	MIN.	TYP.	MAX.	UNIT
Luminous intensity	$I_F = 20\text{ mA}$		I_V	1200	1400	2800	mcd
Radiant intensity	$I_F = 20\text{ mA}$		I_e	-	2.8	-	mW/sr
Conversion factor between flux and intensity			Φ/I	-	4.8	-	sr
Dominant wavelength	$I_F = 20\text{ mA}$	VLMTG1400, VLMTG1401	λ_d	515	525	535	nm
		VLMTG1402	λ_d	520	527	535	nm
Peak wavelength	$I_F = 20\text{ mA}$		λ_p	-	518	-	nm
Angle of half intensity	$I_F = 20\text{ mA}$		φ	-	± 73	-	$^{\circ}$
Spectral line half width	$I_F = 20\text{ mA}$		$\Delta\lambda$	-	35	-	nm
Forward voltage	$I_F = 20\text{ mA}$	VLMTG1400, VLMTG1402	V_F	2.45	2.80	3.05	V
	$I_F = 20\text{ mA}$	VLMTG1401	V_F	2.60	2.80	3.05	V
Reverse current	$V_R = 5\text{ V}$		I_R	-	-	10	μA

LUMINOUS INTENSITY CLASSIFICATION		
GROUP	LUMINOUS INTENSITY (mcd)	
	MIN.	MAX.
W	1200	1800
X	1800	2800

Note

- Luminous intensity is tested at a current pulse duration of 25 ms and an accuracy of $\pm 15\%$.
The above type numbers represent the order groups which include only a few brightness groups. Only one group will be shipped on each reel (there will be no mixing of two groups on each reel). In order to ensure availability, single brightness groups will not be orderable.
In a similar manner for colors where wavelength groups are measured and binned, single wavelength groups will be shipped in any one reel.
In order to ensure availability, single wavelength groups will not be orderable. Also single forward voltage groups are not orderable

COLOR CLASSIFICATION			
COLOR	GROUP	DOMINANT WAVELENGTH (nm)	
		MIN.	MAX.
True green	AN	515	520
	AP	520	525
	AQ	525	530
	AR	530	535

Note

- Wavelengths are tested at a current pulse duration of 25 ms and an accuracy of $\pm 1\text{ nm}$

FORWARD VOLTAGE CLASSIFICATION			
COLOR	GROUP	FORWARD VOLTAGE (V)	
		MIN.	MAX.
True green	J6	2.45	2.60
	J7	2.60	2.75
	J8	2.75	2.90
	J9	2.90	3.05

Note

- Forward voltage is measured with a tolerance of $\pm 0.1\text{ V}$

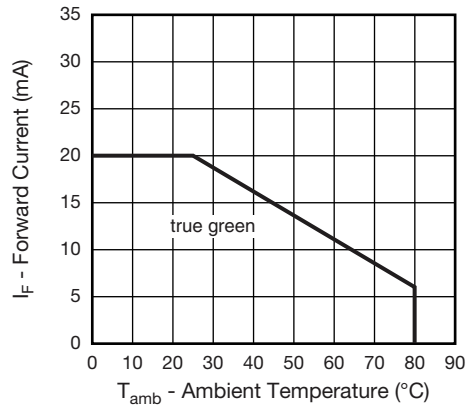
TYPICAL CHARACTERISTICS ($T_{amb} = 25\text{ }^{\circ}\text{C}$, unless otherwise specified)


Fig. 1 - Forward Current vs. Ambient Temperature

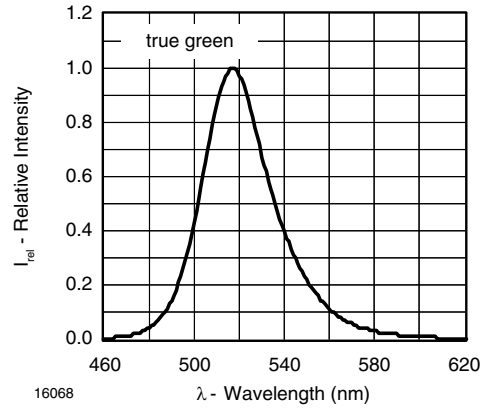


Fig. 4 - Relative Intensity vs. Wavelength

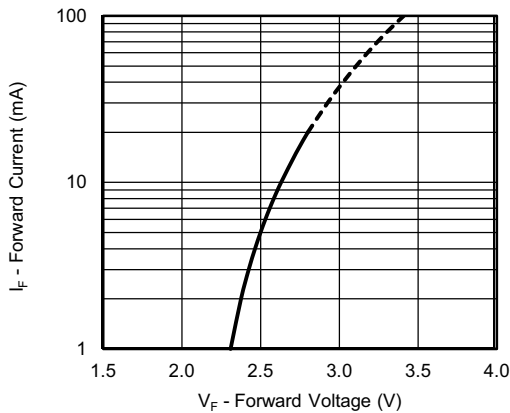


Fig. 2 - Forward Current vs. Forward Voltage

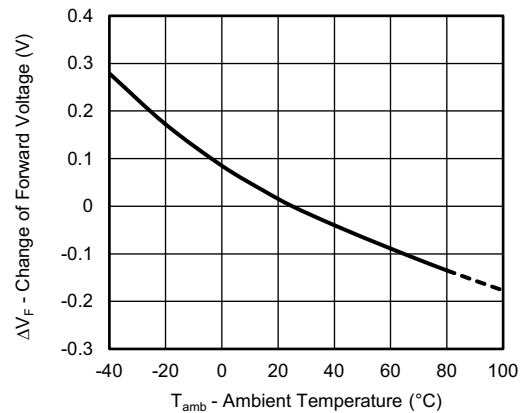


Fig. 5 - Change of Forward Voltage vs. Ambient Temperature

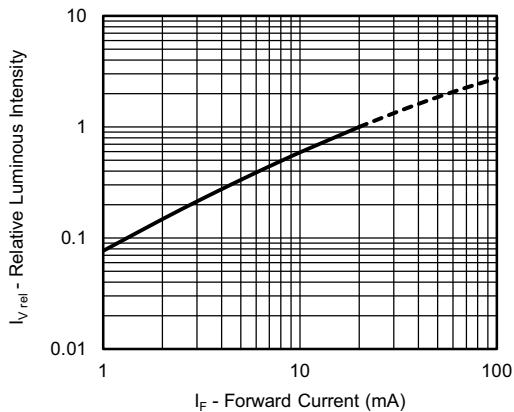


Fig. 3 - Relative Luminous Intensity vs. Forward Current

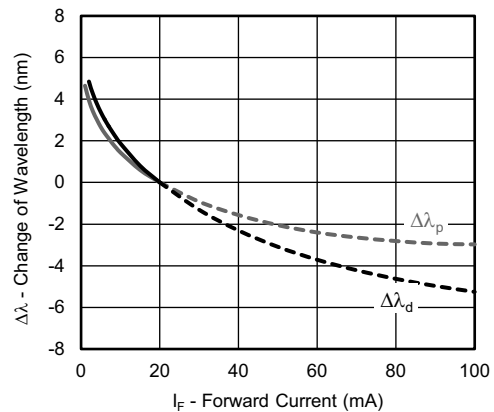


Fig. 6 - Change of Wavelength vs. Forward Current

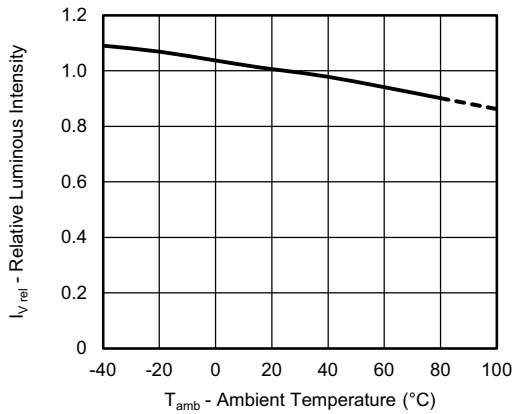


Fig. 7 - Relative Luminous Intensity vs. Ambient Temperature

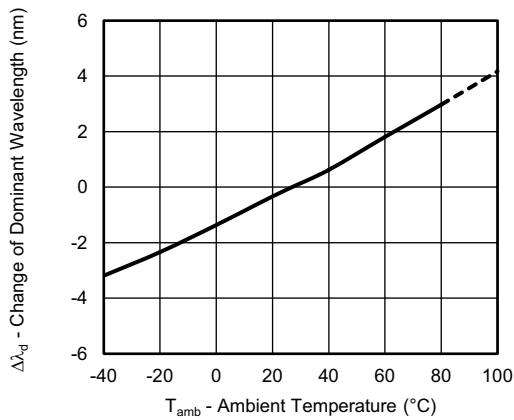


Fig. 8 - Change of Dominant Wavelength vs. Ambient Temperature

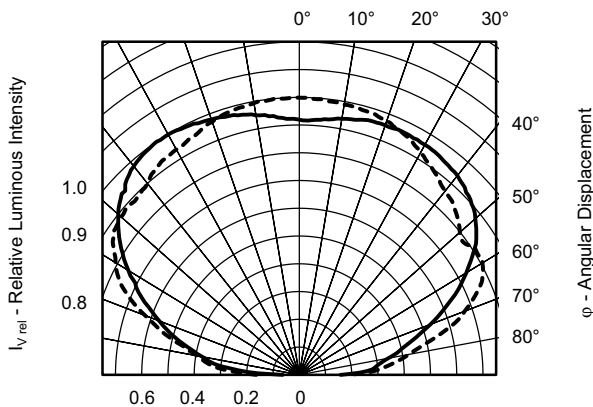
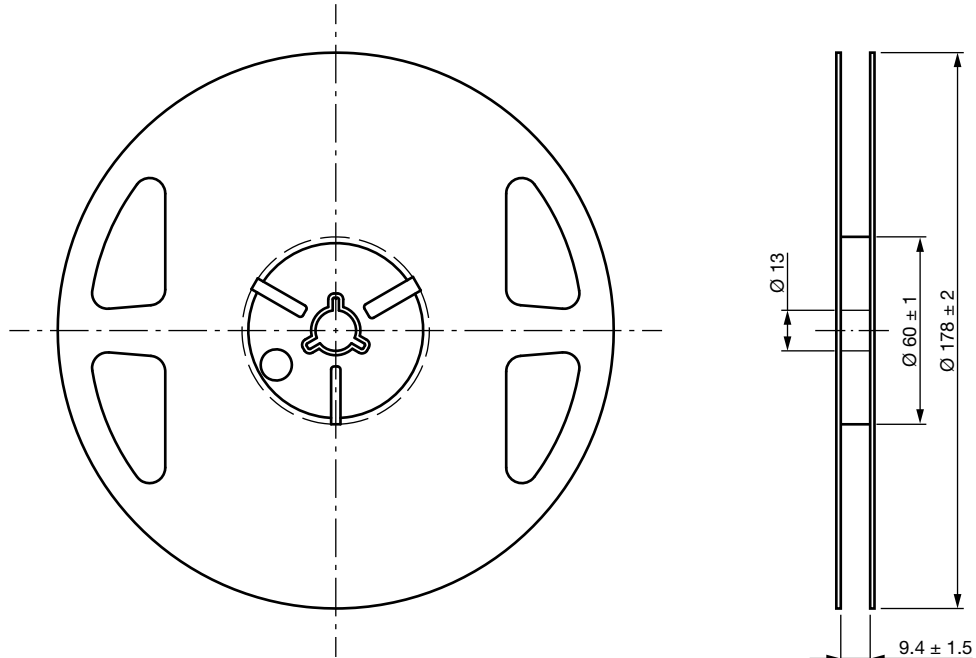


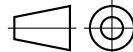
Fig. 9 - Relative Luminous Intensity vs. Angular Displacement



REEL DIMENSIONS in millimeters



Drawing-No.: 9.800-5122.01-4
Issue: 2; 03.11.11

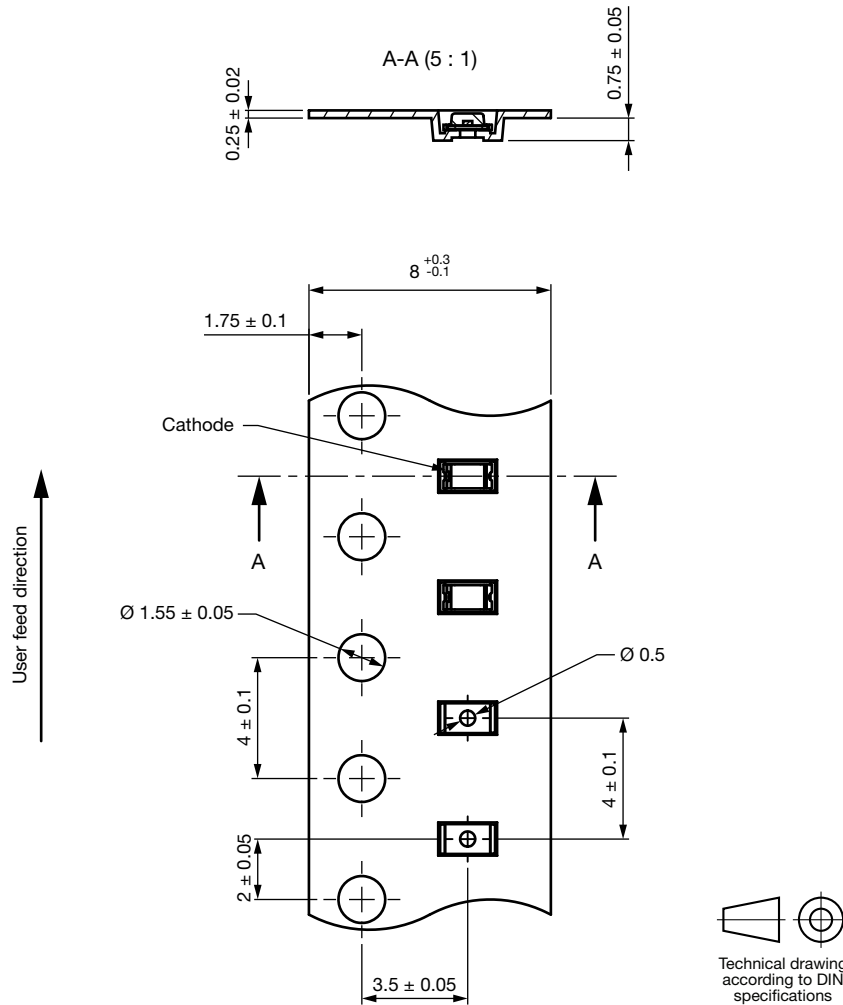

Technical drawing
according to DIN
specifications

3000 pieces on one reel

Minimum order quantity: 9000 pieces



TAPE DIMENSIONS in millimeters

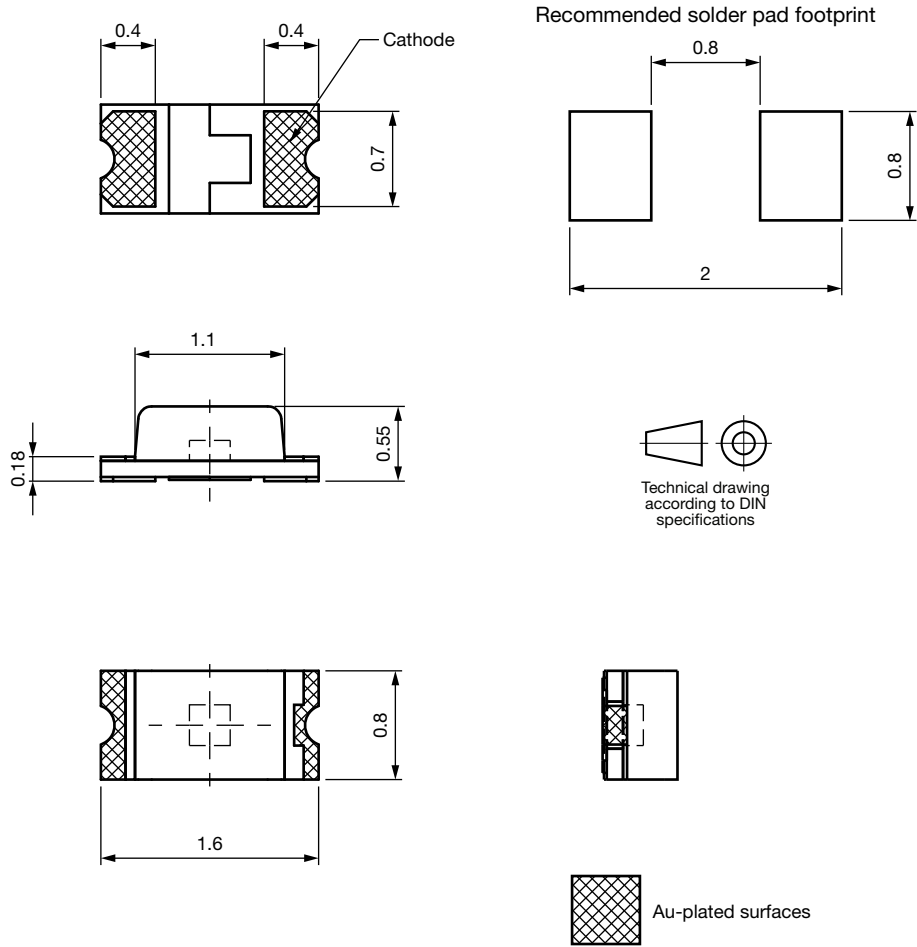


Drawing-No.: 9.700-5407.01-4
Issue: prel; 24.03.17

Not indicated tolerances ± 0.1 mm.

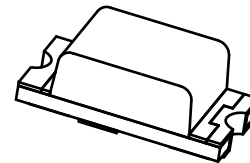


PACKAGE DIMENSIONS in millimeters



Not indicated tolerances ± 0.1 mm.

Drawing-No.: 6.541-5116.01-4
Issue: prel; 29.03.17



SOLDERING PROFILE

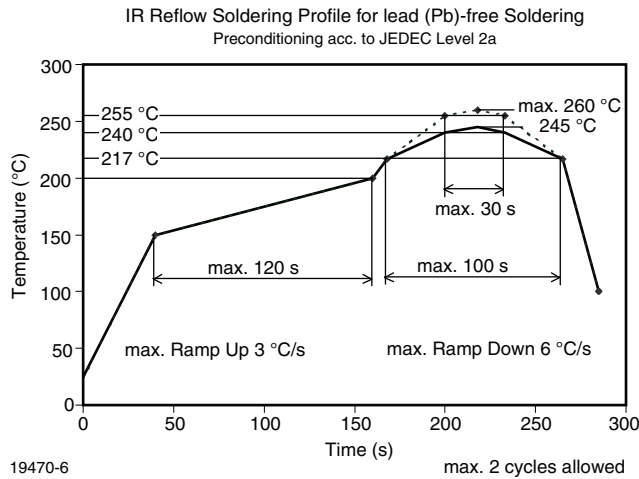
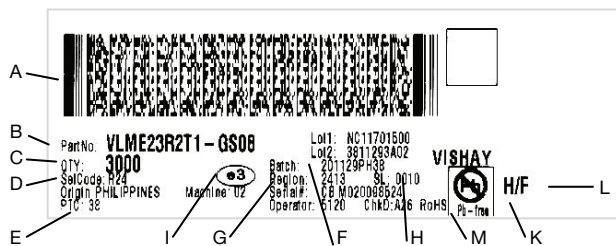


Fig. 10 - Vishay Lead (Pb)-free Reflow Soldering Profile (according to J-STD-020C)

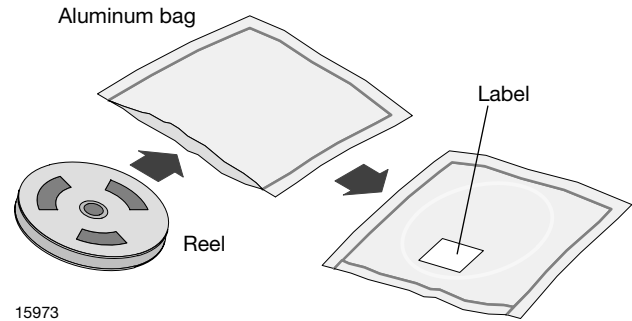
BAR CODE PRODUCT LABEL (example only)



- A. 2D barcode
- B. Vishay part number
- C. Quantity
- D. SelCode = selection code (binning)
- E. PTC = code of manufacturing plant
- F. Batch = date code: year / week / plant code
- G. Region code
- H. SL = sales location
- I. Terminations finishing
- K. Lead (Pb)-free symbol
- L. Halogen-free symbol
- M. RoHS symbol

DRY PACKING

The reel is packed in an anti-humidity bag to protect the devices from absorbing moisture during transportation and storage.



FINAL PACKING

The sealed reel is packed into a cardboard box. A secondary cardboard box is used for shipping purposes.

RECOMMENDED METHOD OF STORAGE

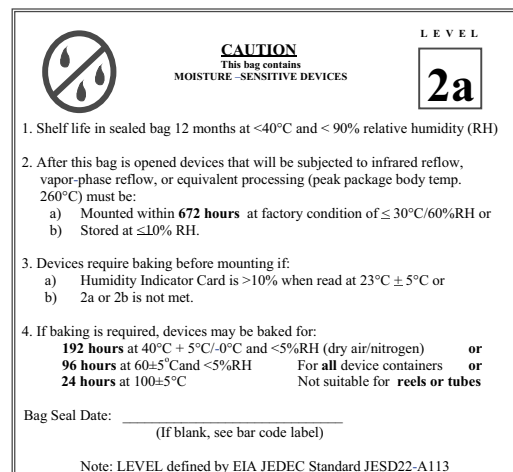
Dry box storage is recommended as soon as the aluminum bag has been opened to prevent moisture absorption. The following conditions should be observed, if dry boxes are not available:

- Storage temperature 10 °C to 30 °C
- Storage humidity ≤ 60 % RH max.

After more than 672 h under these conditions moisture content will be too high for reflow soldering.

In case of moisture absorption, the devices will recover to the former condition by drying under the following condition:
 192 h at 40 °C + 5 °C / - 0 °C and < 5 % RH (dry air / nitrogen) or
 96 h at 60 °C + 5 °C and < 5 % RH for all device containers or
 24 h at 100 °C + 5 °C not suitable for reel or tubes.

An EIA JEDEC standard JESD22-A112 level 2a label is included on all dry bags.



Example of JESD22-A112 level 2a label



ESD PRECAUTION

Proper storage and handling procedures should be followed to prevent ESD damage to the devices especially when they are removed from the antistatic shielding bag. Electrostatic sensitive devices warning labels are on the packaging.

VISHAY SEMICONDUCTORS STANDARD BAR CODE LABELS

The Vishay Semiconductors standard bar code labels are printed at final packing areas. The labels are on each packing unit and contain Vishay Semiconductors specific data.



Disclaimer

ALL PRODUCT, PRODUCT SPECIFICATIONS AND DATA ARE SUBJECT TO CHANGE WITHOUT NOTICE TO IMPROVE RELIABILITY, FUNCTION OR DESIGN OR OTHERWISE.

Vishay Intertechnology, Inc., its affiliates, agents, and employees, and all persons acting on its or their behalf (collectively, "Vishay"), disclaim any and all liability for any errors, inaccuracies or incompleteness contained in any datasheet or in any other disclosure relating to any product.

Vishay makes no warranty, representation or guarantee regarding the suitability of the products for any particular purpose or the continuing production of any product. To the maximum extent permitted by applicable law, Vishay disclaims (i) any and all liability arising out of the application or use of any product, (ii) any and all liability, including without limitation special, consequential or incidental damages, and (iii) any and all implied warranties, including warranties of fitness for particular purpose, non-infringement and merchantability.

Statements regarding the suitability of products for certain types of applications are based on Vishay's knowledge of typical requirements that are often placed on Vishay products in generic applications. Such statements are not binding statements about the suitability of products for a particular application. It is the customer's responsibility to validate that a particular product with the properties described in the product specification is suitable for use in a particular application. Parameters provided in datasheets and / or specifications may vary in different applications and performance may vary over time. All operating parameters, including typical parameters, must be validated for each customer application by the customer's technical experts. Product specifications do not expand or otherwise modify Vishay's terms and conditions of purchase, including but not limited to the warranty expressed therein.

Hyperlinks included in this datasheet may direct users to third-party websites. These links are provided as a convenience and for informational purposes only. Inclusion of these hyperlinks does not constitute an endorsement or an approval by Vishay of any of the products, services or opinions of the corporation, organization or individual associated with the third-party website. Vishay disclaims any and all liability and bears no responsibility for the accuracy, legality or content of the third-party website or for that of subsequent links.

Except as expressly indicated in writing, Vishay products are not designed for use in medical, life-saving, or life-sustaining applications or for any other application in which the failure of the Vishay product could result in personal injury or death. Customers using or selling Vishay products not expressly indicated for use in such applications do so at their own risk. Please contact authorized Vishay personnel to obtain written terms and conditions regarding products designed for such applications.

No license, express or implied, by estoppel or otherwise, to any intellectual property rights is granted by this document or by any conduct of Vishay. Product names and markings noted herein may be trademarks of their respective owners.