

Sxx08xSx & Sxx08x Series

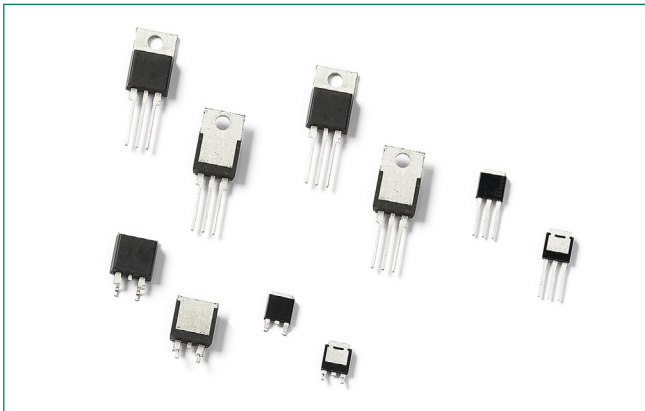

Agency Approval	
Agency	Agency File Number
	E71639*

* - L Package Only

Main Features		
Symbol	Value	Unit
$I_{T(RMS)}$	8	A
V_{DRM}/V_{RRM}	400 to 1000	V
I_{GT}	0.2 to 15	mA

Additional Information

Datasheet

Resources

Samples

Description

This Sxx08x SCR series is ideal for uni-directional switch applications such as phase control, heating, motor speed controls, converters/rectifiers and capacitive discharge ignitions.

These SCRs have a low gate current trigger level of 0.2 to 15 mA at approximately 1.5V, with a sensitive version of this series having a gate trigger current less than 500µA. The sensitive gate SCR version is easily triggered by sense coils, proximity switches, and microprocessors.

Features & Benefits

- Halogen-free and RoHS-compliant
- Glass – passivated junctions
- Voltage capability up to 1000 V
- Surge capability up to 100 A at 60 Hz half cycle
- L - Package is UL Recognized for 2500Vrms

Applications

Typical applications are capacitive discharge systems for strobe lights, nailers, staplers and gas engine ignition. Also AC control & rectification for power tools, home/brown goods, white goods appliances and 2-wheeler rectifier/battery regulators.

Internally constructed isolated packages are offered for ease of heat sinking with highest isolation voltage.

Schematic Symbol

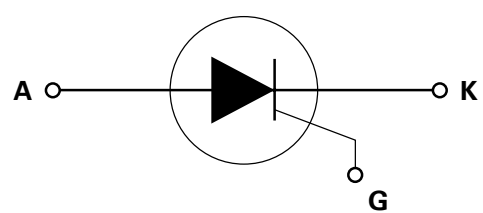

Absolute Maximum Ratings — Sensitive SCRs

Symbol	Parameter	Test Conditions		Value	Unit
$I_{T(RMS)}$	RMS on-state current	Sxx08LSy	$T_c = 80^\circ\text{C}$	8	A
		Sxx08RSy/Sxx08NSy Sxx08DSy Sxx08Vsy	$T_c = 95^\circ\text{C}$		
$I_{T(AV)}$	Average on-state current	Sxx08LSy	$T_c = 80^\circ\text{C}$	5.1	A
		Sxx08RSy/Sxx08NSy Sxx08DSy Sxx08Vsy	$T_c = 95^\circ\text{C}$		
I_{TSM}	Peak non-repetitive surge current	single half cycle; $f = 50\text{Hz}$; T_j (initial) = 25°C		83	A
		single half cycle; $f = 60\text{Hz}$; T_j (initial) = 25°C		100	
I^2t	I^2t Value for fusing	$t_p = 8.3 \text{ ms}$		41	A^2s
di/dt	Critical rate of rise of on-state current	$f = 60 \text{ Hz}; T_j = 110^\circ\text{C}$		70	$\text{A}/\mu\text{s}$
I_{GTM}	Peak gate current	$T_j = 110^\circ\text{C}$		1.6	A
$P_{G(AV)}$	Average gate power dissipation	$T_j = 110^\circ\text{C}$		0.4	W
T_{stg}	Storage temperature range			-40 to 150	$^\circ\text{C}$
T_j	Operating junction temperature range			-40 to 110	$^\circ\text{C}$

Note: xx = voltage, y = sensitivity

Absolute Maximum Ratings — Standard SCRs

Symbol	Parameter	Test Conditions		Value	Unit
$I_{T(RMS)}$	RMS on-state current	Sxx08L	$T_c = 100^\circ\text{C}$	8	A
		Sxx08R/Sxx08N Sxx08D Sxx08V	$T_c = 110^\circ\text{C}$		
$I_{T(AV)}$	Average on-state current	Sxx08L	$T_c = 100^\circ\text{C}$	5.1	A
		Sxx08R/Sxx08N Sxx08D Sxx08V	$T_c = 110^\circ\text{C}$		
I_{TSM}	Peak non-repetitive surge current	single half cycle; $f = 50\text{Hz}$; T_j (initial) = 25°C		83	A
		single half cycle; $f = 60\text{Hz}$; T_j (initial) = 25°C		100	
I^2t	I^2t Value for fusing	$t_p = 8.3 \text{ ms}$		41	A^2s
di/dt	Critical rate-of-rise of on-state current	$f = 60 \text{ Hz}; T_j = 125^\circ\text{C}$		100	$\text{A}/\mu\text{s}$
I_{GM}	Peak gate current	$T_j = 125^\circ\text{C}$		2	A
$P_{G(AV)}$	Average gate power dissipation	$T_j = 125^\circ\text{C}$		0.5	W
T_{stg}	Storage temperature range			-40 to 150	$^\circ\text{C}$
T_j	Operating junction temperature range			-40 to 125	$^\circ\text{C}$

Note: xx = voltage

Electrical Characteristics ($T_J = 25^\circ\text{C}$, unless otherwise specified) – Sensitive SCRs

Symbol	Test Conditions		Value				Unit
			Sxx08xS1	Sxx08xS2	Sxx08xS3	Sxx08x4	
I_{GT}	$V_D = 6\text{V}$ $R_L = 100\ \Omega$	MAX.	50	200	500	100	μA
V_{GT}	$V_D = 6\text{V}$ $R_L = 100\ \Omega$	MAX.	0.8				V
dv/dt	$V_D = V_{DRM}$; $R_{GK} = 1\text{k}\Omega$; $T_J = 110^\circ\text{C}$	TYP.	8				V/ μs
V_{GD}	$V_D = V_{DRM}$ $R_L = 3.3\ \text{k}\Omega$ $T_J = 110^\circ\text{C}$	MIN.	0.2				V
V_{GRM}	$I_{GR} = 10\ \mu\text{A}$	MIN.	6				V
I_H	$I_T = 20\text{mA}$ (initial)	MAX.	4	6	8	5	mA
t_q	$I_T = 2\text{A}$; $t_p = 50\ \mu\text{s}$; dv/dt=5V/ μs ; di/dt=-30A/ μs	MAX.	75	50	45	60	μs
t_{gt}	$I_G = 2 \times I_{GT}$ PW = 15 μs $I_T = 12\text{A}$	TYP.	3	4	5	4	μs

Note: xx = voltage x = package

Electrical Characteristics ($T_J = 25^\circ\text{C}$, unless otherwise specified) – Standard SCRs

Symbol	Test Conditions			Value	Unit
				Sxx08x	
I_{GT}	$V_D = 12\text{V}$ $R_L = 60\ \Omega$		MAX.	15	mA
V_{GT}	$V_D = 12\text{V}$ $R_L = 60\ \Omega$		MAX.	1.5	V
dv/dt	$V_D = V_{DRM}$; gate open; $T_J = 100^\circ\text{C}$	400V	MIN.	350	V/ μs
		600V		300	
		800V		250	
	$V_D = V_{DRM}$; gate open; $T_J = 125^\circ\text{C}$	400V		100	
		600V		250	
		800V		225	
V_{GD}	$V_D = V_{DRM}$ $R_L = 3.3\ \text{k}\Omega$ $T_J = 125^\circ\text{C}$		MIN.	0.2	V
I_H	$I_T = 200\text{mA}$ (initial)		MAX.	30	mA
t_q	$I_T = 2\text{A}$; $t_p = 50\ \mu\text{s}$; dv/dt=5V/ μs ; di/dt=-30A/ μs		MAX.	35	μs
t_{gt}	$I_G = 2 \times I_{GT}$ PW = 15 μs $I_T = 16\text{A}$		TYP.	2	μs

Note: xx = voltage x = package

Static Characteristics

Symbol	Test Conditions		Value	Unit
V_{TM}	$I_T = 16\text{A}$; $t_p = 380\ \mu\text{s}$		MAX.	1.6 V
I_{DRM} / I_{RRM}	Sxx08xyy	$T_J = 25^\circ\text{C}$	400 - 600V	5
		$T_J = 110^\circ\text{C}$	400 - 600V	250
	Sxx08x	$T_J = 25^\circ\text{C}$	400 - 800V	10
			1000V	20
		$T_J = 100^\circ\text{C}$	400 - 800V	200
			1000V	3000
$T_J = 125^\circ\text{C}$	400 - 800V	500		

Note: xx = voltage, x = package, yy = sensitivity

Thermal Resistances

Symbol	Parameter	Value	Unit	
$R_{\theta(J-C)}$	Junction to case (AC)	Sxx08RSy / Sxx08NSy	1.8	°C/W
		Sxx08LSy	3.4	
		Sxx08VSY	2.1	
		Sxx08DSy	1.5	
		Sxx08R / S xx08N	1.8	
		Sxx08L	3.4	
		Sxx08V	2.0	
		Sxx08D	1.5	
$R_{\theta(J-A)}$	Junction to ambient	Sxx08RSy	40	°C/W
		Sxx08LSy	65	
		Sxx08VSY	85	
		Sxx08R	40	
		Sxx08L	50	
		Sxx08V	70	

Note: xx = voltage, y = sensitivity

Figure 1: Normalized DC Gate Trigger Current vs. Junction Temperature (Sensitive SCR)

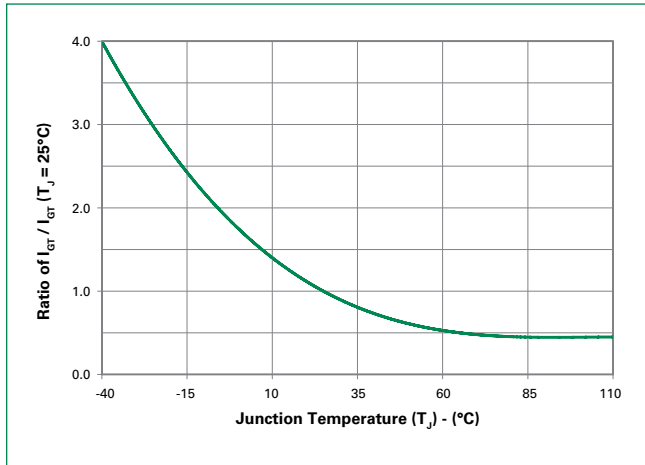

Figure 2: Normalized DC Gate Trigger Current vs. Junction Temperature (Standard SCR)

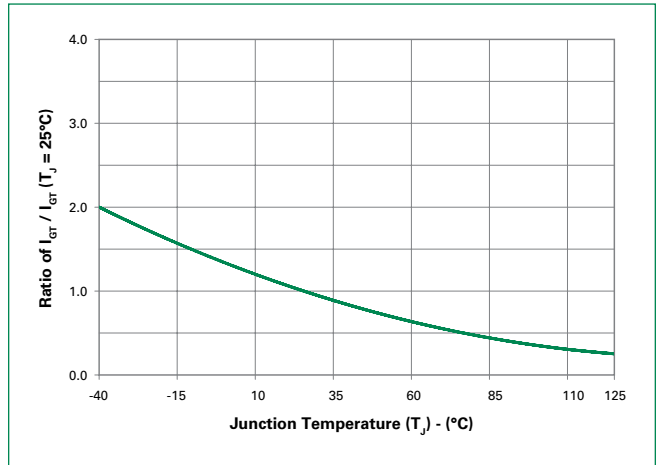

Figure 3: Normalized DC Gate Trigger Voltage vs. Junction Temperature

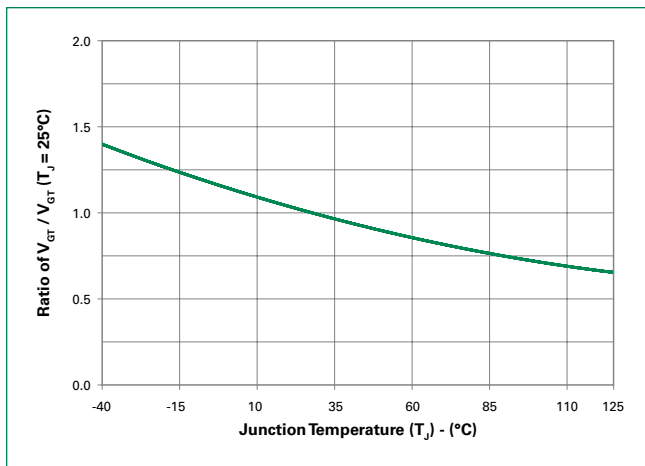

Figure 4: Normalized DC Holding Current vs. Junction Temperature

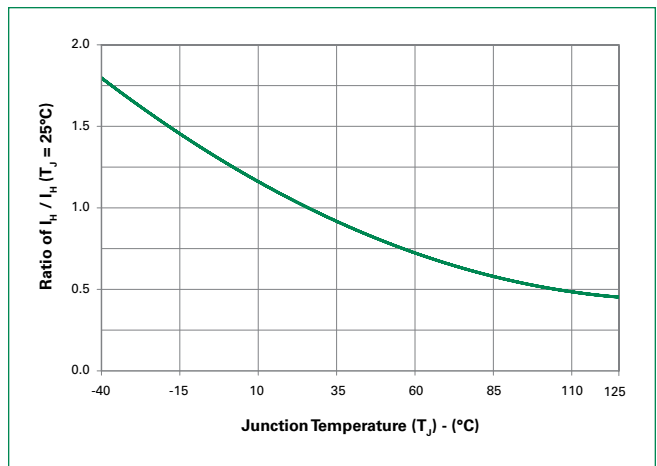

Figure 5: On-State Current vs. On-State Voltage (Typical)

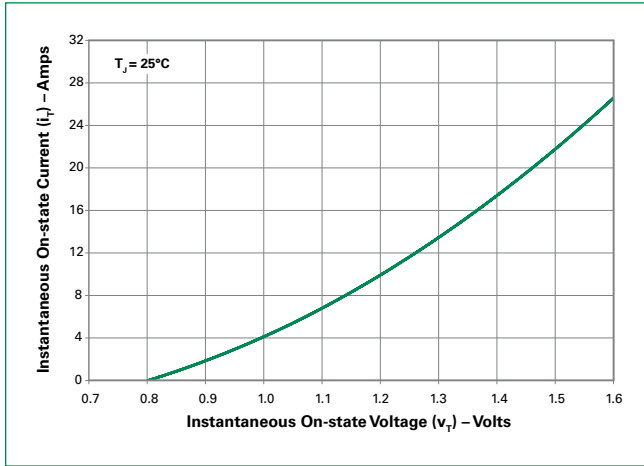

Figure 6: Power Dissipation (Typical) vs. RMS On-State Current

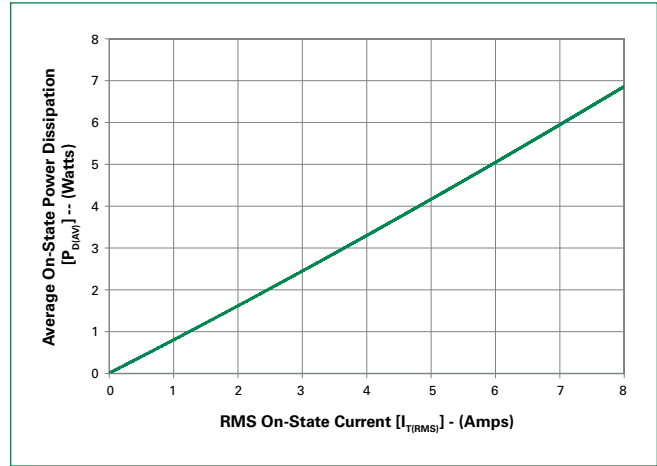

Figure 7: Maximum Allowable Case Temperature vs. RMS On-State Current

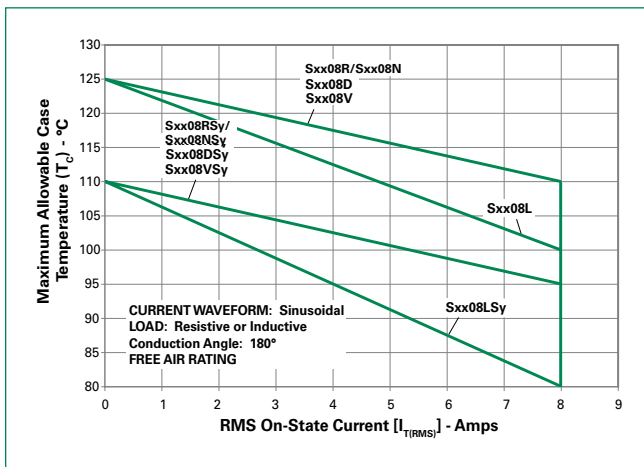

Figure 8: Maximum Allowable Case Temperature vs. Average On-State Current

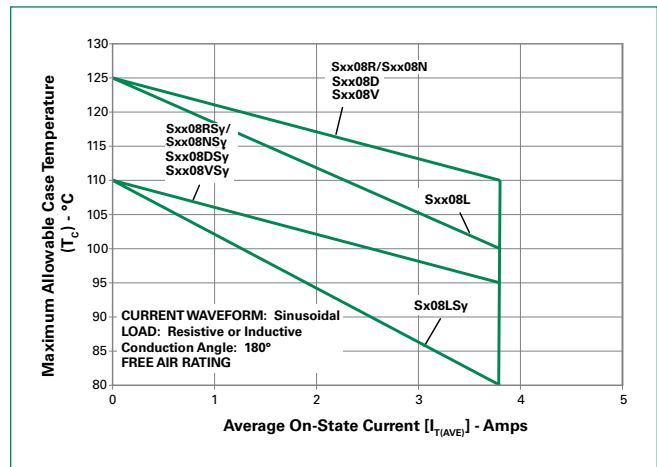

Figure 9: Maximum Allowable Ambient Temperature vs. RMS On-State Current

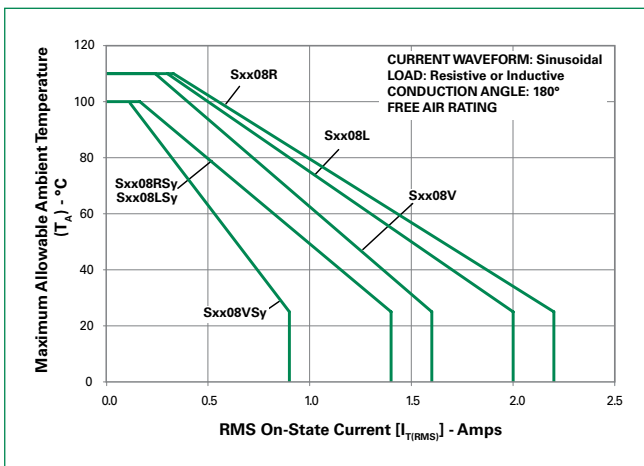
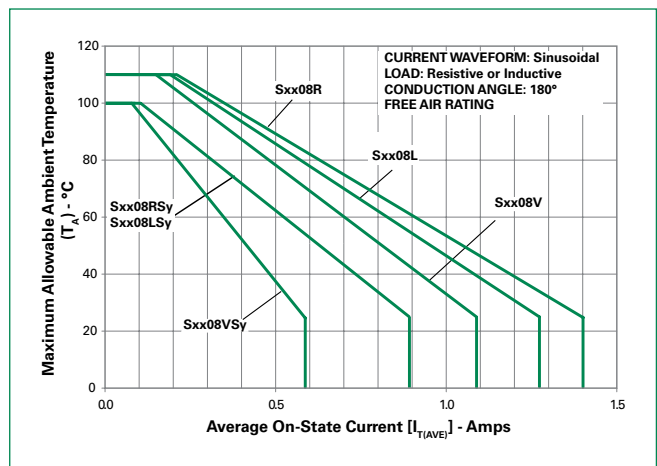

Figure 10: Maximum Allowable Ambient Temperature vs. Average On-State Current



Note: xx = voltage, y = sensitivity

Figure 11: Peak Capacitor Discharge Current

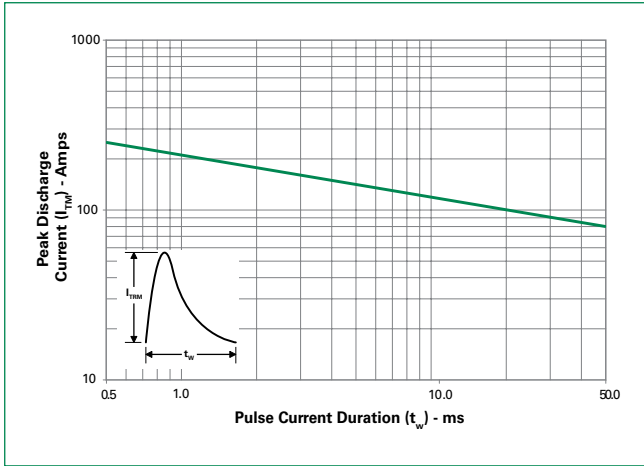

Figure 12: Peak Capacitor Discharge Current Derating

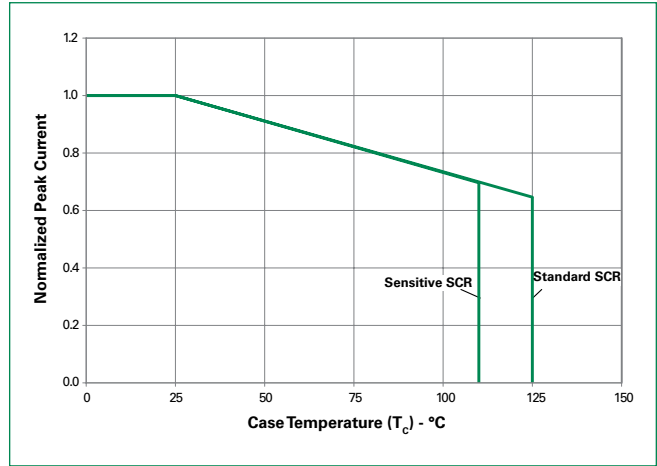

Figure 13-1: Typical DC Gate Trigger Current with R_{GK} vs. Junction Temperature for S6008xS2

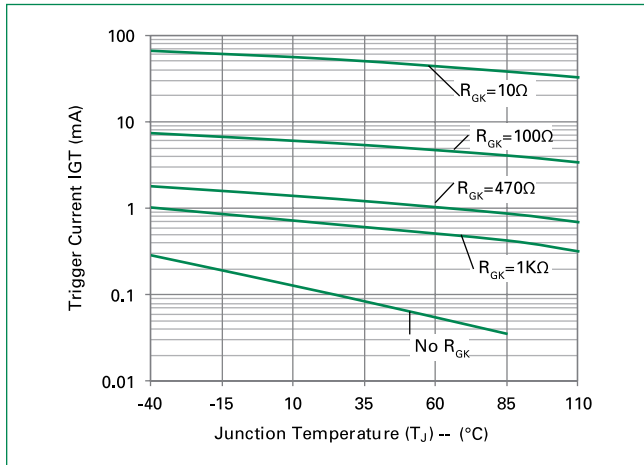

Figure 13-2: Typical DC Gate Trigger Current with R_{GK} vs. Junction Temperature for S6008xS3

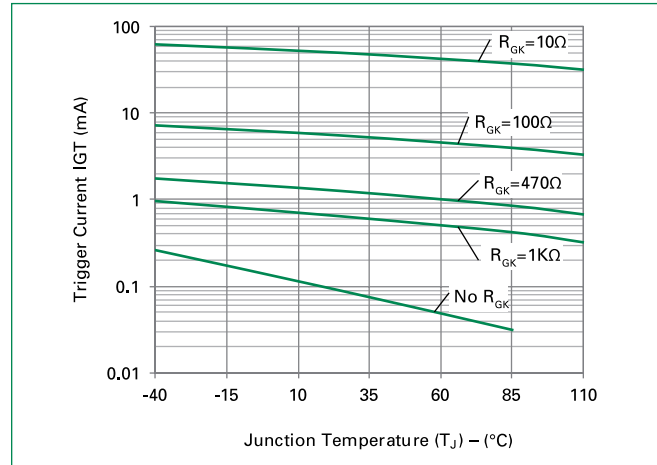

Figure 14-1: Typical DC Holding Current with R_{GK} vs. Junction Temperature for S6008xS2

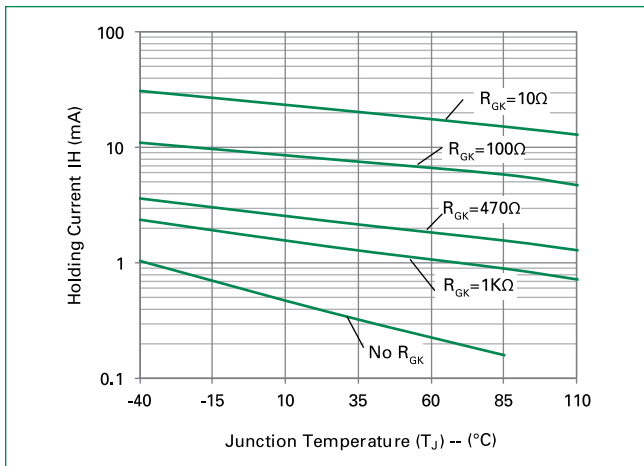

Figure 14-1: Typical DC Holding Current with R_{GK} vs. Junction Temperature for S6008xS3

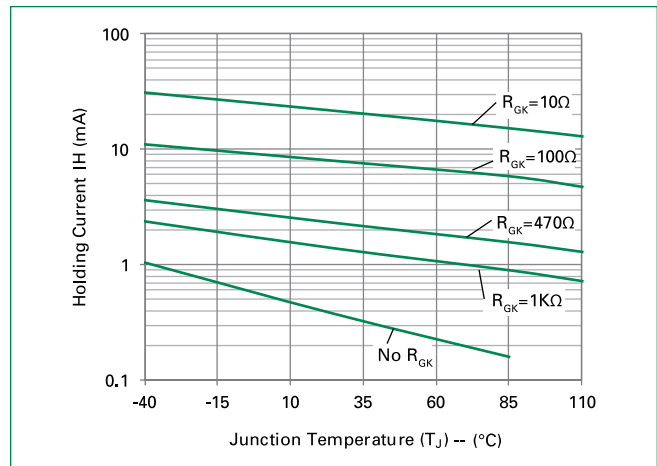

Figure 15-1: Typical Static dv/dt with R_{GK} vs. Junction Temperature for S6008xS2

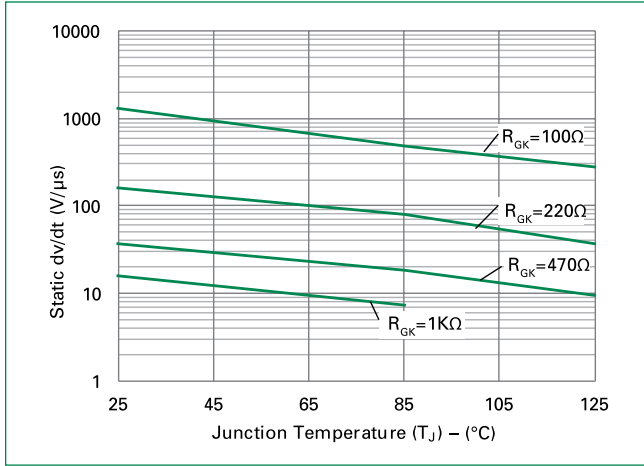

Figure 15-2: Typical Static dv/dt with R_{GK} vs. Junction Temperature for S6008xS3

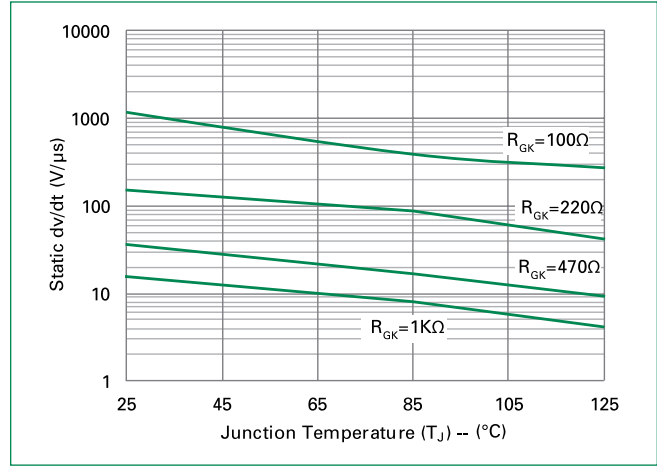

Figure 16-1: Typical turn off time with R_{GK} vs. Junction Temperature for S6008xS2

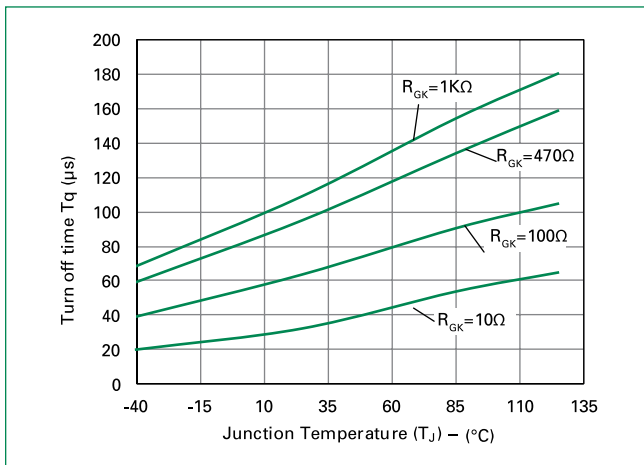

Figure 16-2: Typical DC Gate Trigger Current with R_{GK} vs. Junction Temperature for S6008xS3

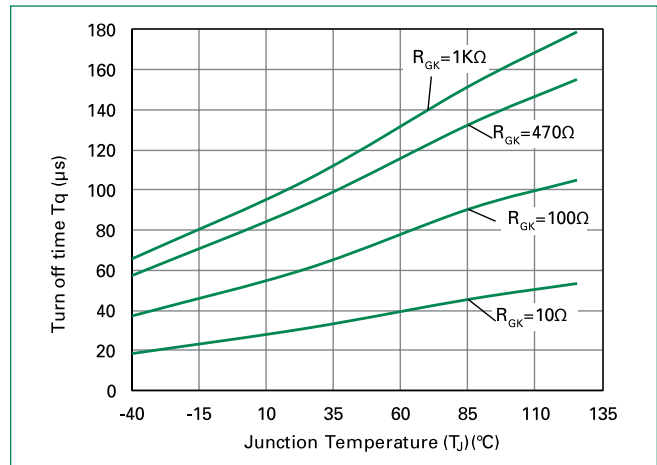
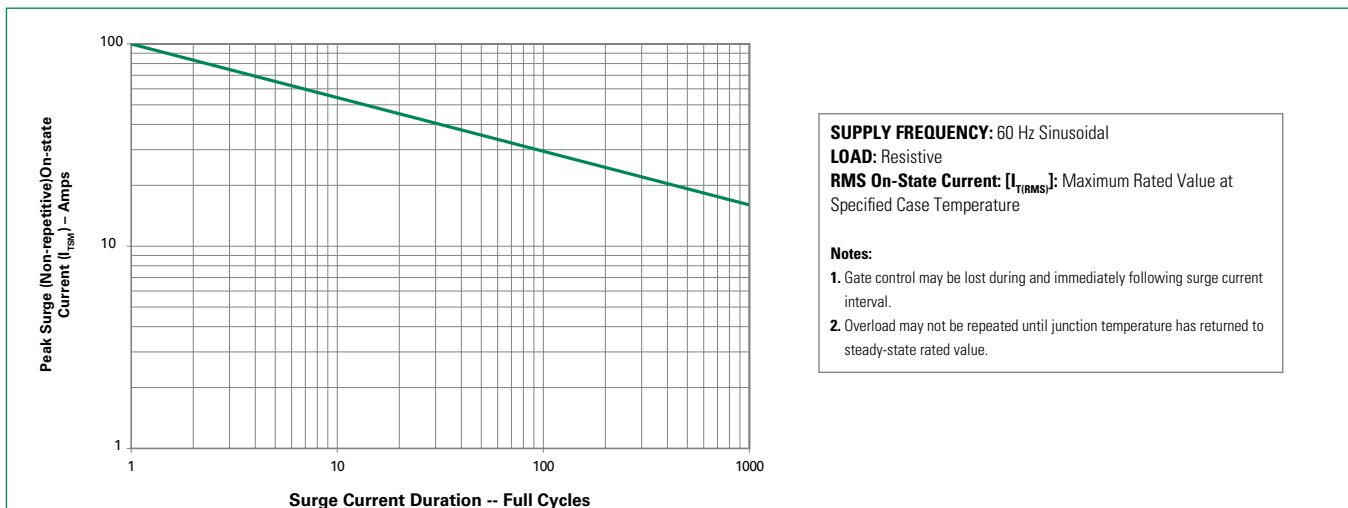
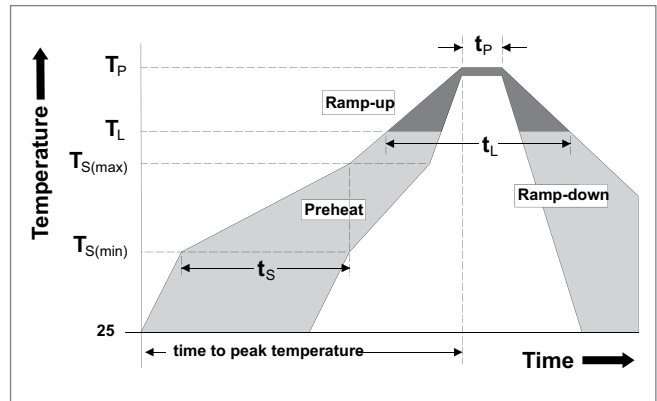

Figure 17: Surge Peak On-State Current vs. Number of Cycles



Soldering Parameters

Reflow Condition		Pb – Free assembly
Pre Heat	- Temperature Min ($T_{s(min)}$)	150°C
	- Temperature Max ($T_{s(max)}$)	200°C
	- Time (min to max) (t_s)	60 – 180 secs
Average ramp up rate (Liquidus Temp) (T_L) to peak		5°C/second max
$T_{s(max)}$ to T_L - Ramp-up Rate		5°C/second max
Reflow	- Temperature (T_L) (Liquidus)	217°C
	- Temperature (t_L)	60 – 150 seconds
Peak Temperature (T_p)		260 ^{+0/-5} °C
Time within 5°C of actual peak Temperature (t_p)		20 – 40 seconds
Ramp-down Rate		5°C/second max
Time 25°C to peak Temperature (T_p)		8 minutes Max.
Do not exceed		280°C



Physical Specifications

Terminal Finish	100% Matte Tin-plated
Body Material	UL recognized epoxy meeting flammability rating 94V-0
Lead Material	Copper Alloy

Design Considerations

Careful selection of the correct component for the application's operating parameters and environment will go a long way toward extending the operating life of the Thyristor. Good design practice should limit the maximum continuous current through the main terminals to 75% of the component rating. Other ways to ensure long life for a power discrete semiconductor are proper heat sinking and selection of voltage ratings for worst case conditions. Overheating, overvoltage (including dv/dt), and surge currents are the main killers of semiconductors. Correct mounting, soldering, and forming of the leads also help protect against component damage.

Environmental Specifications

Test	Specifications and Conditions
AC Blocking	MIL-STD-750, M-1040, Cond A Applied Peak AC voltage @ 125°C for 1008 hours
Temperature Cycling	MIL-STD-750, M-1051, 100 cycles; -40°C to +150°C; 15-min dwell-time
Temperature/Humidity	EIA / JEDEC, JESD22-A101 1008 hours; 320V - DC; 85°C; 85% rel humidity
High Temp Storage	MIL-STD-750, M-1031, 1008 hours; 150°C
Low-Temp Storage	1008 hours; -40°C
Resistance to Solder Heat	MIL-STD-750 Method 2031
Solderability	ANSI/J-STD-002, category 3, Test A
Lead Bend	MIL-STD-750, M-2036 Cond E

Dimensions — TO-220AB (R-Package) — Non-Isolated Mounting Tab Common with Center Lead

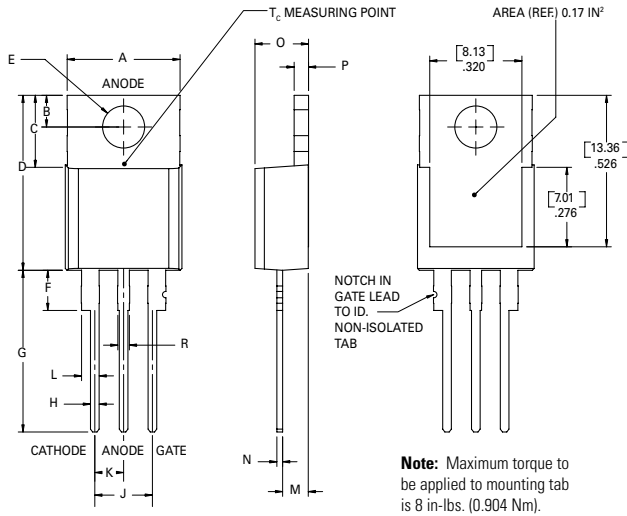

Dimension	Inches		Millimeters	
	Min	Max	Min	Max
A	0.380	0.420	9.65	10.67
B	0.105	0.115	2.67	2.92
C	0.230	0.250	5.84	6.35
D	0.590	0.620	14.99	15.75
E	0.142	0.147	3.61	3.73
F	0.110	0.130	2.79	3.30
G	0.540	0.575	13.72	14.61
H	0.025	0.035	0.64	0.89
J	0.195	0.205	4.95	5.21
K	0.095	0.105	2.41	2.67
L	0.060	0.075	1.52	1.91
M	0.085	0.095	2.16	2.41
N	0.018	0.024	0.46	0.61
O	0.178	0.188	4.52	4.78
P	0.045	0.060	1.14	1.52
R	0.038	0.048	0.97	1.22

Dimensions — TO-220AB (L-Package) — Isolated Mounting Tab

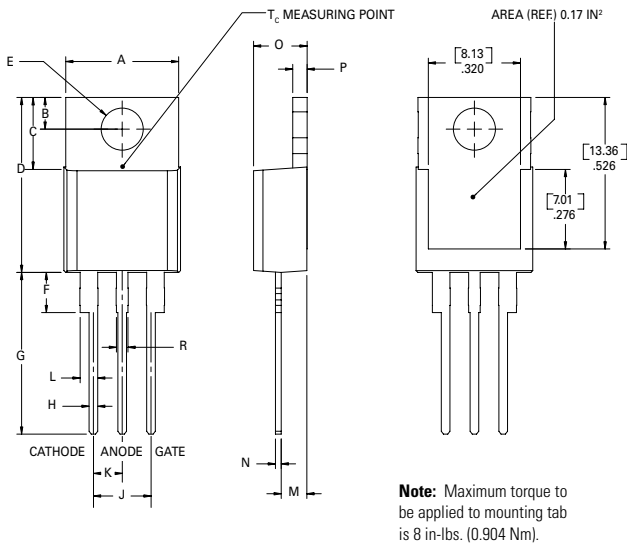

Dimension	Inches		Millimeters	
	Min	Max	Min	Max
A	0.380	0.420	9.65	10.67
B	0.105	0.115	2.67	2.92
C	0.230	0.250	5.84	6.35
D	0.590	0.620	14.99	15.75
E	0.142	0.147	3.61	3.73
F	0.110	0.130	2.79	3.30
G	0.540	0.575	13.72	14.61
H	0.025	0.035	0.64	0.89
J	0.195	0.205	4.95	5.21
K	0.095	0.105	2.41	2.67
L	0.060	0.075	1.52	1.91
M	0.085	0.095	2.16	2.41
N	0.018	0.024	0.46	0.61
O	0.178	0.188	4.52	4.78
P	0.045	0.060	1.14	1.52
R	0.038	0.048	0.97	1.22

Dimensions — TO-251AA (V/I-Package) — V/I-PAK Through Hole

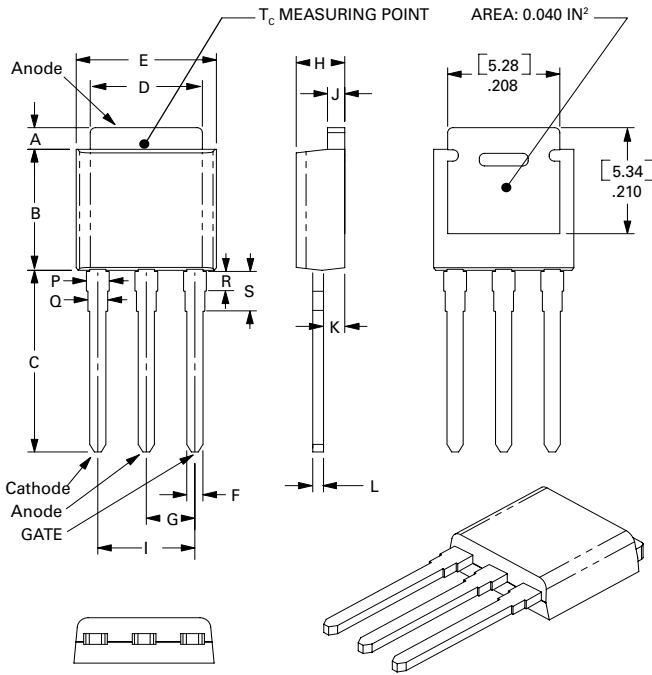

Dimension	Inches			Millimeters		
	Min	Typ	Max	Min	Typ	Max
A	0.037	0.040	0.043	0.94	1.01	1.09
B	0.235	0.242	0.245	5.97	6.15	6.22
C	0.350	0.361	0.375	8.89	9.18	9.53
D	0.205	0.208	0.213	5.21	5.29	5.41
E	0.255	0.262	0.265	6.48	6.66	6.73
F	0.027	0.031	0.033	0.69	0.80	0.84
G	0.087	0.090	0.093	2.21	2.28	2.36
H	0.085	0.092	0.095	2.16	2.34	2.41
I	0.176	0.180	0.184	4.47	4.57	4.67
J	0.018	0.020	0.023	0.46	0.51	0.58
K	0.035	0.037	0.039	0.90	0.95	1.00
L	0.018	0.020	0.023	0.46	0.52	0.58
P	0.042	0.047	0.052	1.06	1.20	1.32
Q	0.034	0.039	0.044	0.86	1.00	1.11
R	0.034	0.039	0.044	0.86	1.00	1.11
S	0.074	0.079	0.084	1.86	2.00	2.11

Dimensions — TO-252AA (D-Package) — D-PAK Surface Mount

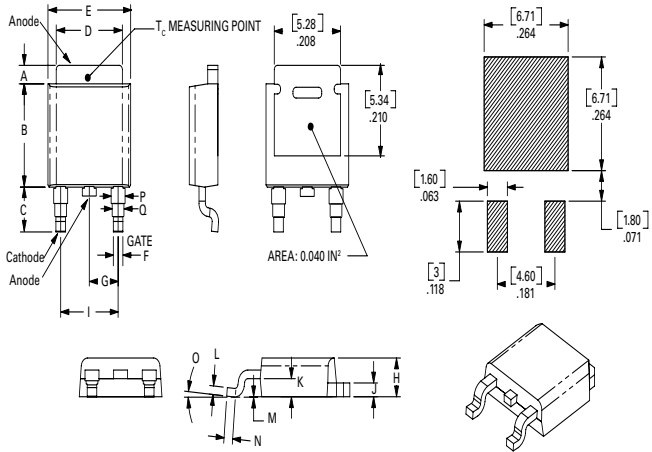

Dimension	Inches			Millimeters		
	Min	Typ	Max	Min	Typ	Max
A	0.037	0.040	0.043	0.94	1.01	1.09
B	0.235	0.243	0.245	5.97	6.16	6.22
C	0.106	0.108	0.113	2.69	2.74	2.87
D	0.205	0.208	0.213	5.21	5.29	5.41
E	0.255	0.262	0.265	6.48	6.65	6.73
F	0.027	0.031	0.033	0.69	0.80	0.84
G	0.087	0.090	0.093	2.21	2.28	2.36
H	0.085	0.092	0.095	2.16	2.33	2.41
I	0.176	0.179	0.184	4.47	4.55	4.67
J	0.018	0.020	0.023	0.46	0.51	0.58
K	0.035	0.037	0.039	0.90	0.95	1.00
L	0.018	0.020	0.023	0.46	0.51	0.58
M	0.000	0.000	0.004	0.00	0.00	0.10
N	0.021	0.026	0.027	0.53	0.67	0.69
O	0°	0°	5°	0°	0°	5°
P	0.042	0.047	0.052	1.06	1.20	1.32
Q	0.034	0.039	0.044	0.86	1.00	1.11

Product Selector

Part Number	Voltage				Gate Sensitivity	Type	Package
	400V	600V	800V	1000V			
Sxx08RS2	X	X	-	-	0.2mA	Sensitive SCR	TO-220R
Sxx08LS2	X	X	-	-	0.2mA	Sensitive SCR	TO-220L
Sxx08VS2	X	X	-	-	0.2mA	Sensitive SCR	TO-251
Sxx08DS2	X	X	-	-	0.2mA	Sensitive SCR	TO-252
Sxx08RS3	X	X	-	-	0.5mA	Sensitive SCR	TO-220R
Sxx08LS3	X	X	-	-	0.5mA	Sensitive SCR	TO-220L
Sxx08VS3	X	X	-	-	0.5mA	Sensitive SCR	TO-251
Sxx08DS3	X	X	-	-	0.5mA	Sensitive SCR	TO-252
Sxx08R	X	X	X	X	15mA	Standard SCR	TO-220R
Sxx08L	X	X	X	X	15mA	Standard SCR	TO-220L
Sxx08V	X	X	X	X	15mA	Standard SCR	TO-251
Sxx08D	X	X	X	X	15mA	Standard SCR	TO-252
Sxx08NS2	X	X	-	-	0.2mA	Sensitive SCR	TO-263
Sxx08NS3	X	X	-	-	0.5mA	Sensitive SCR	TO-263
Sxx08N	X	X	X	X	15mA	Standard SCR	TO-263
Sxx08DS1	-	X	-	-	50µA	Sensitive SCR	TO-252
Sxx08DS4	-	X	-	-	100µA	Sensitive SCR	TO-252

Note: xx = Voltage/10

Packing Options

Part Number	Marking	Weight	Packing Mode	Base Quantity
Sxx08L/RyyTP	Sxx08L/Ryy	2.2 g	Tube	1000 (50 per tube)
Sxx08DyyTP	Sxx08Dyy	0.3 g	Tube	750 (75 per tube)
Sxx08DyyRP	Sxx08Dyy	0.3 g	Embossed Carrier	2500
Sxx08VyyTP	Sxx08Vyy	0.4 g	Tube	750 (75 per tube)
Sxx08L/RTP	Sxx08L/R	2.2 g	Tube	1000 (50 per tube)
Sxx08DTP	Sxx08D	0.3 g	Tube	750 (75 per tube)
Sxx08DRP	Sxx08D	0.3 g	Embossed Carrier	2500
Sxx08NyyTP	Sxx08Nyy	1.6g	Tube	1000 (50 per tube)
Sxx08NyyRP	Sxx08Nyy	1.6g	Embossed Carrier	500
Sxx08NTP	Sxx08N	1.6g	Tube	1000 (50 per tube)
Sxx08NRP	Sxx08N	1.6g	Embossed Carrier	500
Sxx08VRP	Sxx08V	0.4 g	Tube	750 (75 per tube)

Note: xx = Voltage/10; yy = Sensitivity

Mouser Electronics

Authorized Distributor

Click to View Pricing, Inventory, Delivery & Lifecycle Information:

Littelfuse:

[S4008LS2TP](#) [S2008R](#) [S4008F1](#) [S6008DS3RP](#) [S2008FS21](#) [S4008DS3RP](#) [S6008R67](#) [SK008L](#) [S4008FS24](#)
[S8008DRP](#) [S4008DS3TP](#) [S6008DRP](#) [S6008R67TP](#) [S4008DS2TP](#) [S6008VS3TP](#) [S6008L65](#) [S4008VS2TP](#)
[S4008VTP](#) [S6008RS3](#) [S8008VTP](#) [S4008LS2](#) [S6008L56](#) [S2008FS22](#) [S2008VS2TP](#) [S2008DS3TP](#) [S6008R](#)
[S2008VTP](#) [S6008L53](#) [S6008DS3TP](#) [S4008FS21](#) [S2008LS3](#) [S6008L](#) [S6008FS21](#) [S4008DS2RP](#) [S2008F1](#)
[S4008DRP](#) [S8008R](#) [S4008R](#) [S6008LS2](#) [S8008L](#) [SK008DTP](#) [SK008R](#) [S2008DS3RP](#) [S2008FS31](#) [S6008L58](#)
[S2008F12](#) [S2008R55](#) [S4008LS3](#) [S6008LS3](#) [S4008L](#) [S8008DTP](#) [S6008F1](#) [S6008DTP](#) [S2008DS2RP](#)
[S2008VS3TP](#) [S2008L](#) [SK008DRP](#) [S6008VS2TP](#) [S6008DS2RP](#) [S6008VTP](#) [S4008DTP](#) [SK008VTP](#) [S6008LTP](#)
[S6008FS31](#) [S4008FS31](#) [S2008DRP](#) [S6008DS2TP](#) [S2008DS2TP](#) [S2008LS2](#) [S6008LS2TP](#) [S4008RS2](#)
[S6008RS3TP](#) [SK008RTP](#) [SK008LTP](#) [S4008RS2TP](#) [S4008LTP](#) [S4008LS3TP](#) [S6008LS3TP](#) [S8008RTP](#) [S6008RTP](#)
[S4008RTP](#) [S8008LTP](#) [S6008RS2TP](#) [S4008RS3TP](#)