

MICRO-CON-X[®] 2-7

NEW PRODUCT BULLETIN C708

CONXALL[®]

A SWITCHCRAFT COMPANY



CONXALL • 601 E Wildwood • Villa Park, IL 60181 • 630-834-7504
Please visit conxall.com for the most up-to-date product specifications. Made in USA.

MICRO-CON-X® 2-7

NEW PRODUCT BULLETIN C708



FEATURES & BENEFITS

- Up to 7 contacts in compact design
- IP-67 rating, at the face (when mated)
- IP-67 molded cable assemblies (when mated)
- All plastic design is light weight
- Variety of standard options to meet all design specifications
- Custom cable assemblies available
- UL recognized

APPLICATIONS

- Instrumentation
- Medical Equipment
- Lighting
- GPS Locating Devices
- Data Acquisition
- General industrial electronic applications



CONXALL • 601 E Wildwood • Villa Park, IL 60181 • 630-834-7504
Please visit conxall.com for the most up-to-date product specifications. Made in USA.

MICRO-CON-X® 2-7

NEW PRODUCT BULLETIN C708

SPECIFICATIONS

Mechanical Specifications

Life:	Minimum 300 cycles insertion / withdrawal cycles
Vibration:	Coupling rings have overriding locking feature to prevent loosening or separation of connector
Hex Nut Torque:	9 in-lb max tightening torque.
Coupling Locking Style:	Bayonet with ribbed coupling nut (winged coupling nut available) P/N 16482
Backshell Style:	Non-removable snap lock
Conductor Sizes:	#20 accepts 20 through 24 AWG #22 contacts accepts 22 through 24 AWG #26 contacts accepts 24 through 28 AWG

Electrical Specifications

Voltage Rating:	600V AC/DC
Current Rating:	7.5 A – max (See Electrical Current Rating Chart)

Environmental Specifications

Operating Temperature Rating:	-40°C to +85°C (-40°F to +185°F)
Salt Atmosphere (Corrosion):	300 Hr salt spray when mated
Weathertight:	IP67 at the face, when mated

Material Specifications

Backshell:	Thermoplastic, UL 94HB, Black
Contacts:	Copper Alloy, Gold over Nickel Plate
Coupling Ring:	Thermoplastic, UL 94HB, Black
Gasket:	Elastomer, Black
Grommet / Strain Relief:	Elastomer, Black
Hex Nut:	Thermoplastic, UL 94HB, Black
O-Ring:	Elastomer, Black
Shell:	Thermoplastic, UL 94HB, Black
Optional Dust Cap:	Elastomer, Black

Molded Cable Assemblies

Weathertight:	NEMA 6P, 13: IEC IP67
---------------	-----------------------

Certifications

UL File E150822
CSA File 181200
Not for current interruption
RoHS compliant
REACH compliant

Options

UV Rating:	f1 available
Flame Rating:	UL 94-HB; UL 94V-0 available

Consult factory for optional colors and materials

CONTACT SIZE	CONDUCTOR SIZE - AWG	NUMBER OF CONDUCTORS	CURRENT RATING
#20	#18	1 through 3	7.5A
	#20	1 through 3	7.5A
#22	#22	4	6.0A
	#24	4	6.0A
#26	#24	5, 6	4.0A
	#26	5, 6	4.0A
	#24	7	3.5A
	#26	7	3.5A
	#28*	5-7	2.0A

*Not UL tested for this wire conductor size



CONXALL • 601 E Wildwood • Villa Park, IL 60181 • 630-834-7504
Please visit conxall.com for the most up-to-date product specifications. Made in USA.

MICRO-CON-X® 2-7

NEW PRODUCT BULLETIN C708

PANEL MOUNT / CABLE TO CABLE CONNECTORS

Front View | Wire View

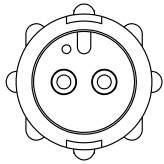

2 POSITION
#20 PIN & SOCKET
CONTACT

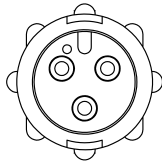

3 POSITION
#20 PIN & SOCKET
CONTACT

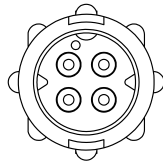

4 POSITION
#22 PIN & SOCKET
CONTACT

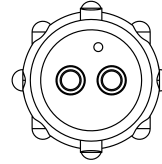

2 POSITION
#20 PIN & SOCKET
CONTACT

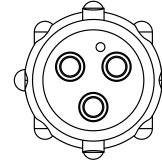

3 POSITION
#20 PIN & SOCKET
CONTACT

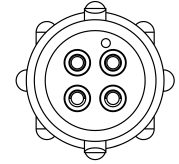

4 POSITION
#22 PIN & SOCKET
CONTACT

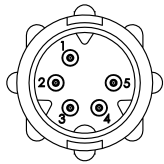

5 POSITION B-KEY
#26 PIN & SOCKET
CONTACT

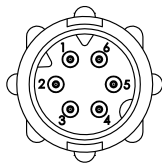

6 POSITION A-KEY
#26 PIN & SOCKET
CONTACT

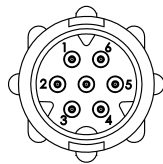

7 POSITION B-KEY
#26 PIN & SOCKET
CONTACT

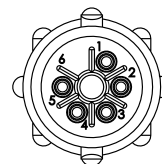

5 POSITION B-KEY
#26 PIN & SOCKET
CONTACT

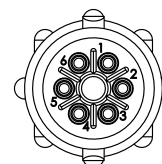

6 POSITION A-KEY
#26 PIN & SOCKET
CONTACT

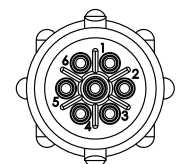

7 POSITION B-KEY
#26 PIN & SOCKET
CONTACT

CABLE CONNECTORS

Front View | Wire View

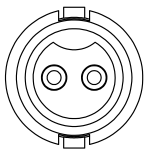

2 POSITION
#20 PIN & SOCKET
CONTACT

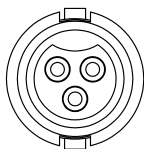

3 POSITION
#20 PIN & SOCKET
CONTACT

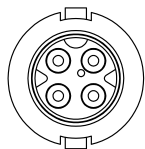

4 POSITION
#22 PIN & SOCKET
CONTACT

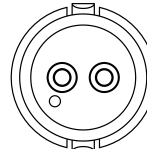

2 POSITION
#20 PIN & SOCKET
CONTACT

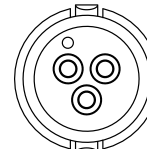

3 POSITION
#20 PIN & SOCKET
CONTACT

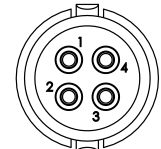

4 POSITION
#22 PIN & SOCKET
CONTACT

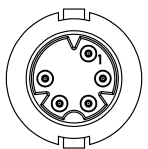

5 POSITION B-KEY
#26 PIN & SOCKET
CONTACT

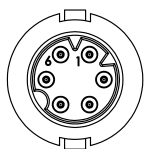

6 POSITION A-KEY
#26 PIN & SOCKET
CONTACT

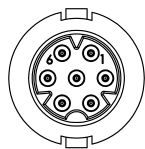

7 POSITION B-KEY
#26 PIN & SOCKET
CONTACT

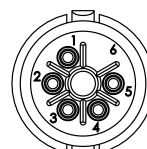

5 POSITION B-KEY
#26 PIN & SOCKET
CONTACT

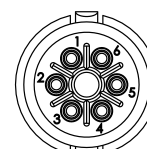

6 POSITION A-KEY
#26 PIN & SOCKET
CONTACT

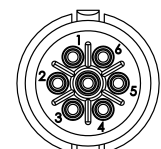

7 POSITION B-KEY
#26 PIN & SOCKET
CONTACT



MICRO-CON-X[®] 2-7

NEW PRODUCT BULLETIN C708

CABLE

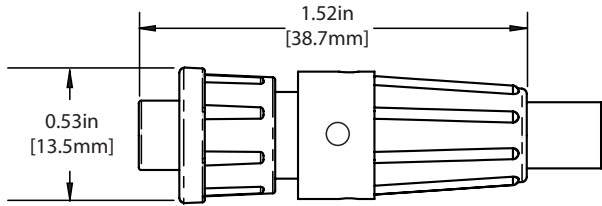

16XXX-XXG-5XX
FIELD INSTALLABLE
CABLE CONNECTOR
BACKSHELL TYPE 5-LONG

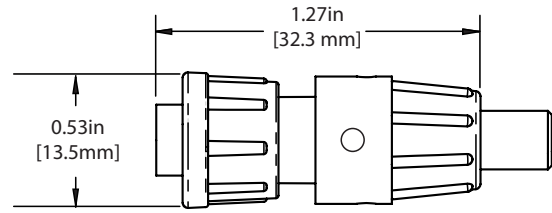

16XXX-XXG-3XX
FIELD INSTALLABLE
CABLE CONNECTOR
BACKSHELL TYPE 3-SHORT
2 & 3 POSITION ONLY

CABLE TO CABLE

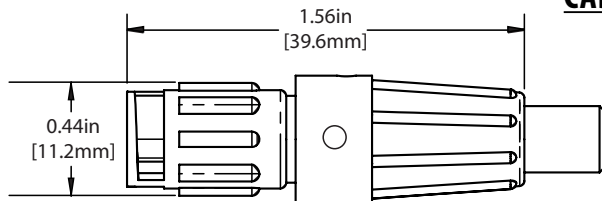

18XXX-XXG-5XX
FIELD INSTALLABLE
CABLE TO CABLE
CONNECTOR
BACKSHELL TYPE 5-LONG

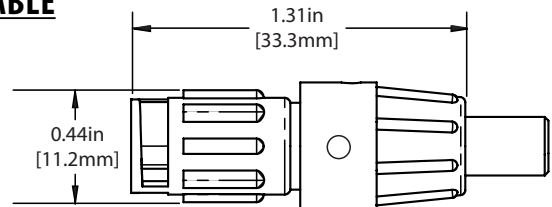

18XXX-XXG-3XX
FIELD INSTALLABLE
CABLE TO CABLE
CONNECTOR
BACKSHELL TYPE 3-SHORT
2 & 3 POSITION ONLY

PANEL

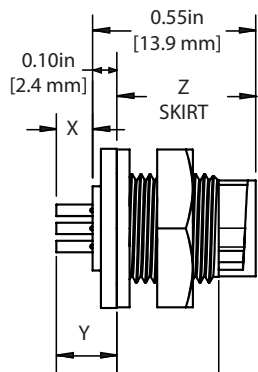

17X80-XXG-3XX
PANEL MOUNT CONNECTOR
CRIMP

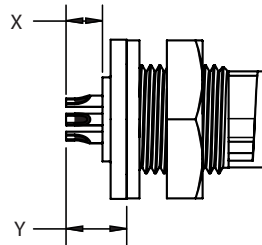

17X82-XXG-3XX
PANEL MOUNT CONNECTOR
SOLDER CUP

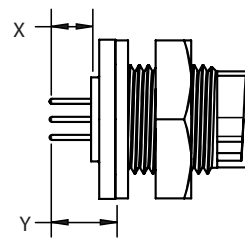

17X8X-XXG-3XX
PANEL MOUNT CONNECTOR
PC TAIL

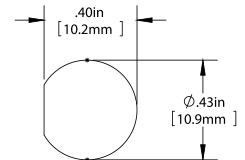
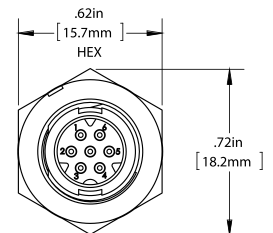

**RECOMMENDED
PANEL CUT-OUT**
TOLERANCE: ±.003

*X, Y, Z - CONSULT FACTORY

All dimensions are for reference only.



CONXALL • 601 E Wildwood • Villa Park, IL 60181 • 630-834-7504
Please visit conxall.com for the most up-to-date product specifications. Made in USA.

MICRO-CON-X® 2-7

NEW PRODUCT BULLETIN C708

ORDERING CODE

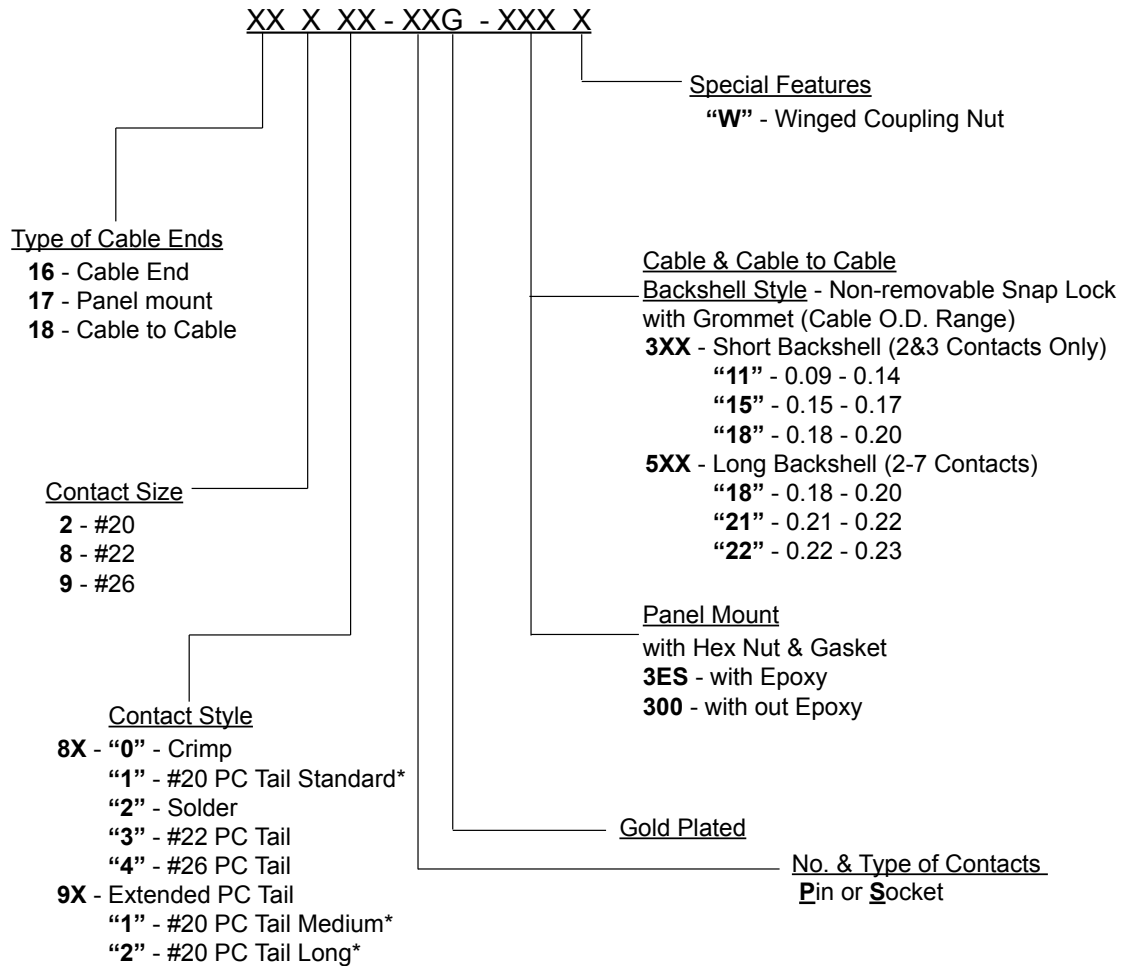

*Consult factory for length and diameter of PC Tail. Additionally, alternative colors and materials are available.



CONXALL • 601 E Wildwood • Villa Park, IL 60181 • 630-834-7504
Please visit conxall.com for the most up-to-date product specifications. Made in USA.