

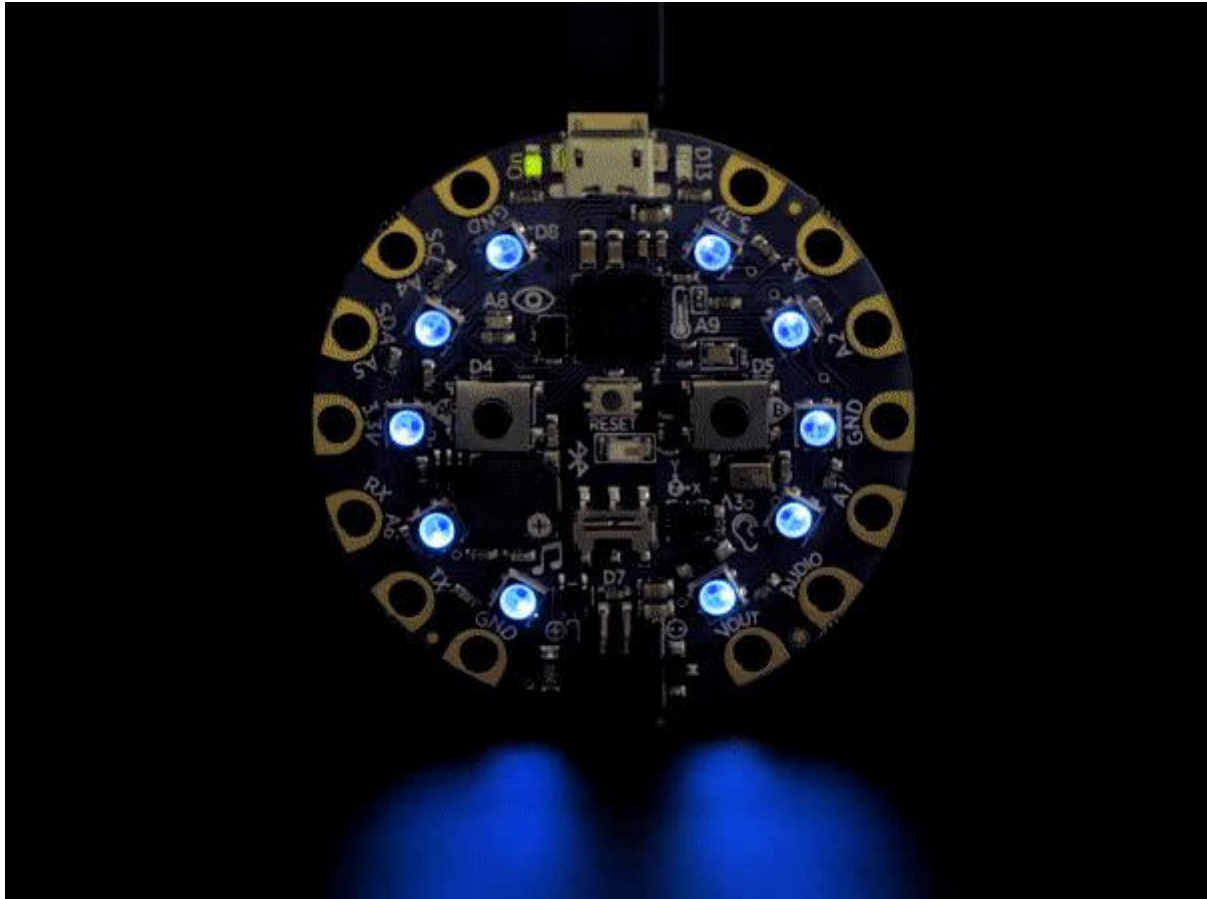

# Adafruit Circuit Playground Bluefruit

Created by Kattni Rembor



<https://learn.adafruit.com/adafruit-circuit-playground-bluefruit>

Last updated on 2023-10-04 12:16:28 PM EDT

# Table of Contents

<a href="#">Overview</a>	9
<a href="#">Update Bootloader</a>	11
<a href="#">Use UF2</a>	12
<ul style="list-style-type: none"><li>• <a href="#">Download update-bootloader UF2</a></li><li>• <a href="#">Enter Bootloader Mode</a></li><li>• <a href="#">Drap &amp; Drop UF2</a></li><li>• <a href="#">Issues</a></li></ul>	
<a href="#">Use Arduino IDE</a>	14
<a href="#">Use Command Line</a>	16
<ul style="list-style-type: none"><li>• <a href="#">Download Bootloader Package</a></li><li>• <a href="#">Download adafruit-nrfutil</a></li><li>• <a href="#">Update Bootloader</a></li></ul>	
<a href="#">Guided Tour</a>	18
<ul style="list-style-type: none"><li>• <a href="#">Power and Data</a></li><li>• <a href="#">Micro B USB connector</a></li><li>• <a href="#">JST Battery Input</a></li><li>• <a href="#">Alligator/Croc Clip Pads</a></li><li>• <a href="#">Microchips</a></li><li>• <a href="#">LEDs</a></li><li>• <a href="#">Green ON LED</a></li><li>• <a href="#">Red #13 LED</a></li><li>• <a href="#">10 x Color NeoPixel LED</a></li><li>• <a href="#">Speaker</a></li><li>• <a href="#">Sensors</a></li><li>• <a href="#">Light Sensor</a></li><li>• <a href="#">Temperature Sensor</a></li><li>• <a href="#">Microphone Audio Sensor</a></li><li>• <a href="#">Motion Sensor</a></li><li>• <a href="#">Capacitive Touch</a></li><li>• <a href="#">Switches &amp; Buttons</a></li></ul>	
<a href="#">Pinouts</a>	25
<ul style="list-style-type: none"><li>• <a href="#">Power Pads</a></li><li>• <a href="#">Input/Output Pads</a></li><li>• <a href="#">Common to all pads</a></li><li>• <a href="#">Each Pin!</a></li><li>• <a href="#">Internally Used Pins!</a></li><li>• <a href="#">Debug Interface</a></li></ul>	
<a href="#">What is CircuitPython?</a>	30
<ul style="list-style-type: none"><li>• <a href="#">CircuitPython is based on Python</a></li><li>• <a href="#">Why would I use CircuitPython?</a></li></ul>	
<a href="#">CircuitPython on Circuit Playground Bluefruit</a>	32
<ul style="list-style-type: none"><li>• <a href="#">Install or Update CircuitPython</a></li></ul>	

<b>Circuit Playground Bluefruit CircuitPython Libraries</b>	<b>34</b>
<ul style="list-style-type: none"><li>• <a href="#">Installing CircuitPython Libraries on Circuit Playground Bluefruit</a></li></ul>	
<b>Getting Started with BLE and CircuitPython</b>	<b>36</b>
<ul style="list-style-type: none"><li>• <a href="#">Guides</a></li></ul>	
<b>Installing the Mu Editor</b>	<b>38</b>
<ul style="list-style-type: none"><li>• <a href="#">Download and Install Mu</a></li><li>• <a href="#">Starting Up Mu</a></li><li>• <a href="#">Using Mu</a></li></ul>	
<b>Creating and Editing Code</b>	<b>40</b>
<ul style="list-style-type: none"><li>• <a href="#">Creating Code</a></li><li>• <a href="#">Editing Code</a></li><li>• <a href="#">Back to Editing Code...</a></li><li>• <a href="#">Naming Your Program File</a></li></ul>	
<b>Connecting to the Serial Console</b>	<b>45</b>
<ul style="list-style-type: none"><li>• <a href="#">Are you using Mu?</a></li><li>• <a href="#">Serial Console Issues or Delays on Linux</a></li><li>• <a href="#">Setting Permissions on Linux</a></li><li>• <a href="#">Using Something Else?</a></li></ul>	
<b>Interacting with the Serial Console</b>	<b>48</b>
<b>The REPL</b>	<b>51</b>
<ul style="list-style-type: none"><li>• <a href="#">Entering the REPL</a></li><li>• <a href="#">Interacting with the REPL</a></li><li>• <a href="#">Returning to the Serial Console</a></li></ul>	
<b>CircuitPython Libraries</b>	<b>55</b>
<ul style="list-style-type: none"><li>• <a href="#">The Adafruit Learn Guide Project Bundle</a></li><li>• <a href="#">The Adafruit CircuitPython Library Bundle</a></li><li>• <a href="#">Downloading the Adafruit CircuitPython Library Bundle</a></li><li>• <a href="#">The CircuitPython Community Library Bundle</a></li><li>• <a href="#">Downloading the CircuitPython Community Library Bundle</a></li><li>• <a href="#">Understanding the Bundle</a></li><li>• <a href="#">Example Files</a></li><li>• <a href="#">Copying Libraries to Your Board</a></li><li>• <a href="#">Understanding Which Libraries to Install</a></li><li>• <a href="#">Example: ImportError Due to Missing Library</a></li><li>• <a href="#">Library Install on Non-Express Boards</a></li><li>• <a href="#">Updating CircuitPython Libraries and Examples</a></li><li>• <a href="#">CircUp CLI Tool</a></li></ul>	
<b>Frequently Asked Questions</b>	<b>66</b>
<ul style="list-style-type: none"><li>• <a href="#">Using Older Versions</a></li><li>• <a href="#">Python Arithmetic</a></li><li>• <a href="#">Wireless Connectivity</a></li><li>• <a href="#">Asyncio and Interrupts</a></li><li>• <a href="#">Status RGB LED</a></li><li>• <a href="#">Memory Issues</a></li><li>• <a href="#">Unsupported Hardware</a></li></ul>	

## CircuitPython Expectations

71

- [Always Run the Latest Version of CircuitPython and Libraries](#)
- [I have to continue using CircuitPython 3.x or 2.x, where can I find compatible libraries?](#)
- [Switching Between CircuitPython and Arduino](#)
- [The Difference Between Express And Non-Express Boards](#)
- [Non-Express Boards: Gemma, Trinket, and QT Py](#)
- [Differences Between CircuitPython and MicroPython](#)
- [Differences Between CircuitPython and Python](#)

## Troubleshooting

75

- [Always Run the Latest Version of CircuitPython and Libraries](#)
- [I have to continue using CircuitPython 5.x or earlier. Where can I find compatible libraries?](#)
- [Bootloader \(boardnameBOOT\) Drive Not Present](#)
- [Windows Explorer Locks Up When Accessing boardnameBOOT Drive](#)
- [Copying UF2 to boardnameBOOT Drive Hangs at 0% Copied](#)
- [CIRCUITPY Drive Does Not Appear or Disappears Quickly](#)
- [Device Errors or Problems on Windows](#)
- [Serial Console in Mu Not Displaying Anything](#)
- [code.py Restarts Constantly](#)
- [CircuitPython RGB Status Light](#)
- [CircuitPython 7.0.0 and Later](#)
- [CircuitPython 6.3.0 and earlier](#)
- [Serial console showing ValueError: Incompatible .mpy file](#)
- [CIRCUITPY Drive Issues](#)
- [Safe Mode](#)
- [To erase CIRCUITPY: storage.erase\\_filesystem\(\)](#)
- [Erase CIRCUITPY Without Access to the REPL](#)
- [For the specific boards listed below:](#)
- [For SAMD21 non-Express boards that have a UF2 bootloader:](#)
- [For SAMD21 non-Express boards that do not have a UF2 bootloader:](#)
- [Running Out of File Space on SAMD21 Non-Express Boards](#)
- [Delete something!](#)
- [Use tabs](#)
- [On MacOS?](#)
- [Prevent & Remove MacOS Hidden Files](#)
- [Copy Files on MacOS Without Creating Hidden Files](#)
- [Other MacOS Space-Saving Tips](#)
- [Device Locked Up or Boot Looping](#)

## "Uninstalling" CircuitPython

93

- [Backup Your Code](#)
- [Moving Circuit Playground Express to MakeCode](#)
- [Moving to Arduino](#)

## Welcome to the Community!

96

- [Adafruit Discord](#)
- [CircuitPython.org](#)
- [Adafruit GitHub](#)
- [Adafruit Forums](#)
- [Read the Docs](#)

## CircuitPython Made Easy

105

## CircuitPython Playground

105

<b>CircuitPython Pins and Modules</b>	<b>106</b>
<ul style="list-style-type: none"><li>• <a href="#">CircuitPython Pins</a></li><li>• <a href="#">import board</a></li><li>• <a href="#">I2C, SPI, and UART</a></li><li>• <a href="#">What Are All the Available Names?</a></li><li>• <a href="#">Microcontroller Pin Names</a></li><li>• <a href="#">CircuitPython Built-In Modules</a></li></ul>	
<b>CircuitPython Built-Ins</b>	<b>112</b>
<ul style="list-style-type: none"><li>• <a href="#">Thing That Are Built In and Work</a></li><li>• <a href="#">Flow Control</a></li><li>• <a href="#">Math</a></li><li>• <a href="#">Tuples, Lists, Arrays, and Dictionaries</a></li><li>• <a href="#">Classes, Objects and Functions</a></li><li>• <a href="#">Lambdas</a></li><li>• <a href="#">Random Numbers</a></li></ul>	
<b>CircuitPython Digital In &amp; Out</b>	<b>113</b>
<ul style="list-style-type: none"><li>• <a href="#">Going Beyond the Lesson!</a></li></ul>	
<b>CircuitPython Analog In</b>	<b>116</b>
<ul style="list-style-type: none"><li>• <a href="#">Creating an Analog Input</a></li><li>• <a href="#">GetVoltage Helper</a></li><li>• <a href="#">Main Loop</a></li></ul>	
<b>CircuitPython Servo</b>	<b>119</b>
<ul style="list-style-type: none"><li>• <a href="#">Servo Wiring</a></li><li>• <a href="#">Standard Servo Code</a></li><li>• <a href="#">Continuous Servo Code</a></li></ul>	
<b>CircuitPython Audio Out</b>	<b>124</b>
<ul style="list-style-type: none"><li>• <a href="#">Basic Tones</a></li><li>• <a href="#">Playing Audio Files</a></li><li>• <a href="#">Installing Project Code</a></li></ul>	
<b>CircuitPython Cap Touch</b>	<b>129</b>
<ul style="list-style-type: none"><li>• <a href="#">Creating an capacitive touch input</a></li><li>• <a href="#">Main Loop</a></li><li>• <a href="#">Capacitive Touch and the Audio Pin on Circuit Playground Bluefruit</a></li></ul>	
<b>CircuitPython NeoPixel</b>	<b>134</b>
<b>CircuitPython DotStar</b>	<b>137</b>
<ul style="list-style-type: none"><li>• <a href="#">Wire It Up</a></li><li>• <a href="#">The Code</a></li><li>• <a href="#">Create the LED</a></li><li>• <a href="#">DotStar Helpers</a></li><li>• <a href="#">Main Loop</a></li><li>• <a href="#">Is it SPI?</a></li><li>• <a href="#">Read the Docs</a></li></ul>	
<b>CircuitPython UART Serial</b>	<b>144</b>
<ul style="list-style-type: none"><li>• <a href="#">The Code</a></li><li>• <a href="#">Wire It Up</a></li><li>• <a href="#">Where's my UART?</a></li></ul>	

- Trinket M0: Create UART before I2C

---

## CircuitPython I2C 152

- Wire It Up
- Find Your Sensor
- I2C Sensor Data
- Installing Project Code
- Where's my I2C?

---

## CircuitPython HID Keyboard 160

---

## CircuitPython CPU Temp 163

---

## CircuitPython Storage 164

- boot.py
- Installing Project Code
- Logging the Temperature

---

## Playground Temperature 169

---

## Playground Light Sensor 171

---

## Playground Drum Machine 172

- Installing Project Code

---

## Playground Sound Meter 175

- Installing Project Code

---

## Playground Color Picker 179

- Installing Project Code

---

## Playground Bluetooth Plotter 181

- Installing Project Code

---

## Arduino Support Setup 185

- 1. BSP Installation
- 2. LINUX ONLY: adafruit-nrfutil Tool Installation
- 3. Update the bootloader (nRF52832 ONLY)
- Advanced Option: Manually Install the BSP via 'git'

---

## Arduino BLE Examples 188

- Example Source Code
- Documented Examples

---

## Advertising: Beacon 190

- Complete Code
- Output

---

## BLE UART: Controller 192

- Setup
- Complete Code

---

## Custom: HRM 199

- HRM Service Definition

- [Implementing the HRM Service and Characteristics](#)
- [Service + Characteristic Setup Code Analysis](#)
- [Full Sample Code](#)

## [Bluefruit LE Connect](#)

---

206

- [Install Bluefruit LE](#)
- [Enable Bluetooth](#)
- [Enable Location Services](#)
- [Scan for Devices](#)
- [Connect](#)
- [Controller Module](#)
- [Color Picker](#)

## [Downloads](#)

---

211

- [Files:](#)
- [Schematic for Circuit Playground Bluefruit](#)
- [Fab print of Circuit Playground Bluefruit](#)



---

# Overview

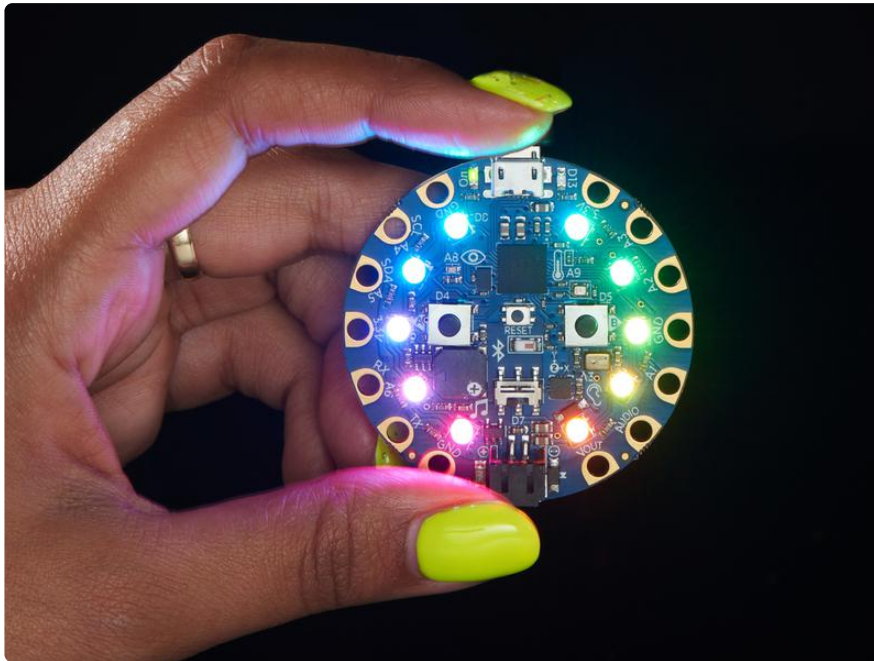

Your board's bootloader must be 0.6.1 or later to be able to load CircuitPython 8.2.0 or later. See the Update Bootloader section in this guide.

Circuit Playground Bluefruit is our third board in the Circuit Playground series, another step towards a perfect introduction to electronics and programming. We've taken the popular Circuit Playground Express and made it even better! Now the main chip is an nRF52840 microcontroller which is not only more powerful, but also comes with Bluetooth Low Energy support for wireless connectivity.

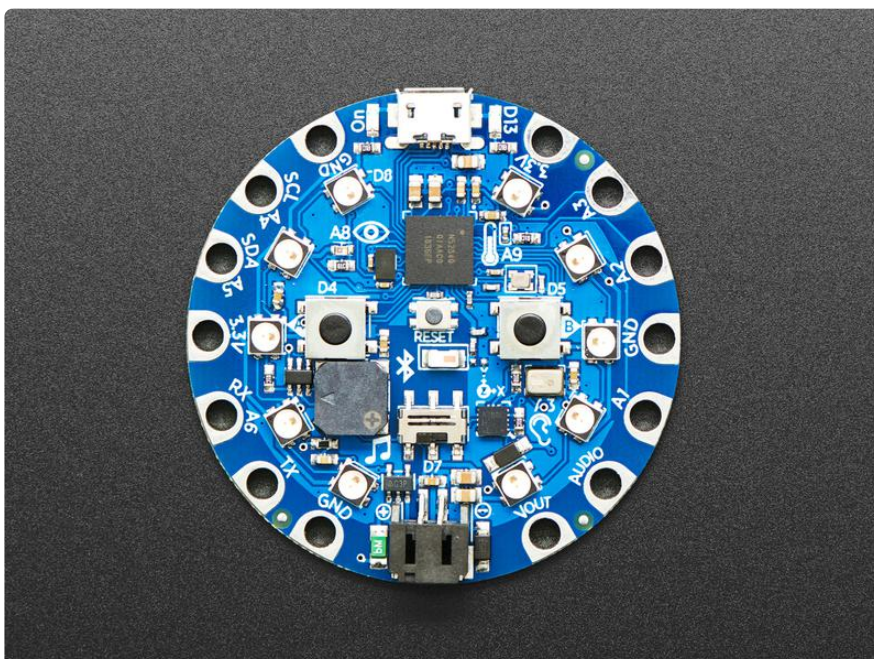

The board is round and has alligator-clip pads around it so you don't have to solder or sew to make it work. You can power it from USB, [a AAA battery pack \(http://adafru.it/727\)](http://adafru.it/727), or with a Lipoly battery (for advanced users). Circuit Playground Bluefruit has built-in USB support. Built in USB means you plug it in to program it and it just shows up, no special cable or adapter required. Just program your code into the board then take it on the go!

For folks who are comfortable with an early-release-version that does not support wireless capabilities, you can also try [MakeCode Maker \(\)](#)'s block-based GUI coding environment on this board.

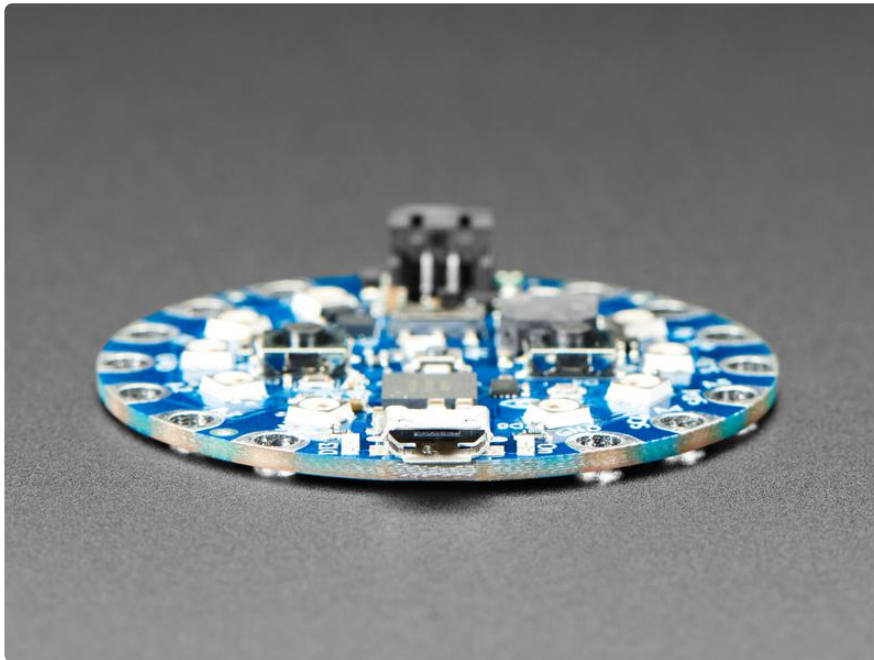

Here's some of the great goodies baked in to each Circuit Playground Bluefruit:

- 1 x nRF52840 Cortex M4 processor with Bluetooth Low Energy support
- 10 x mini NeoPixels, each one can display any color
- 1 x Motion sensor (LIS3DH triple-axis accelerometer with tap detection, free-fall detection)
- 1 x Temperature sensor (thermistor)
- 1 x Light sensor (phototransistor). Can also act as a color sensor and pulse sensor.
- 1 x Sound sensor (MEMS microphone)
- 1 x Mini speaker with class D amplifier (7.5mm magnetic speaker/buzzer)
- 2 x Push buttons, labeled A and B
- 1 x Slide switch
- 8 x alligator-clip friendly input/output pins
- Includes I2C, UART, 6 pins that can do analog inputs, multiple PWM outputs
- Green "ON" LED so you know its powered

- Red "#13" LED for basic blinking
- Reset button
- 2 MB of SPI Flash storage, used primarily with CircuitPython to store code and libraries.
- MicroUSB port for programming and debugging
- USB port can act like serial port, keyboard, mouse, joystick or MIDI!

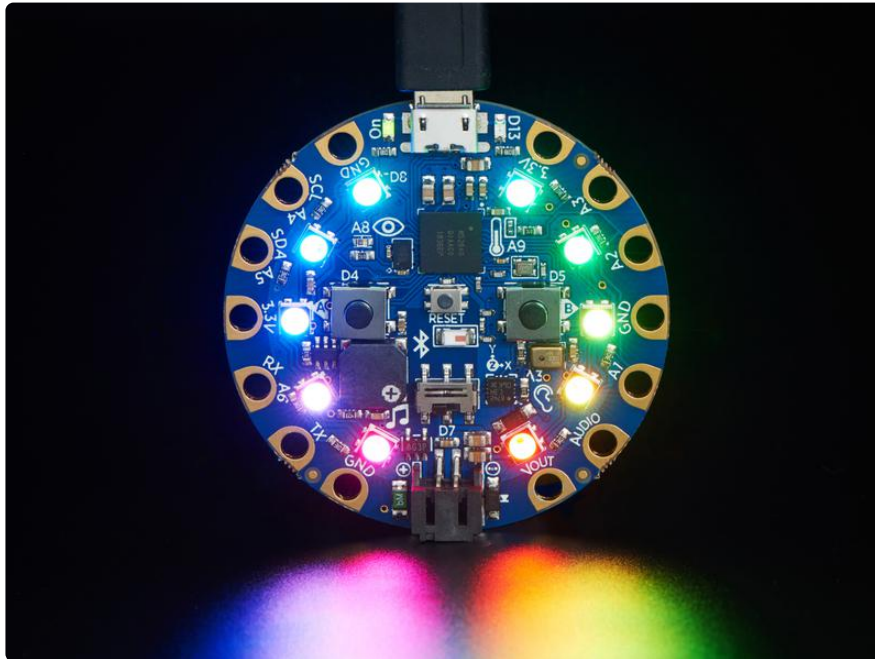

## Update Bootloader

Your board's bootloader must be 0.6.1 or later to be able to load CircuitPython 8.2.0 or later.

Older versions of Adafruit's nRF52840 boards were shipped with a bootloader that does not handle large UF2's, including CircuitPython 8.2.0 and later, and has other issues. To check whether you need to update the bootloader, double-click the reset button, and look in the `...BOOT` drive for `INFO_UF2.TXT`. Inside that file, check the version number. It should be 0.6.1 or newer. This one is older:

```
UF2 Bootloader 0.2.9 lib/nrfx (v1.1.0-1-g096e770) lib/tinyusb (legacy-755-
g55874813) s140 6.1.1
Model: Adafruit Feather nRF52840 Express
Board-ID: nRF52840-Feather-revD
Bootloader: s140 6.1.1
Date: Feb 22 2019
```

The adafruit nRF52 Bootloader can be upgraded/downgraded without any additional hardware. There are 3 different ways to update bootloader, each has its pros and cons:

- Use UF2: This is the fastest and safest way to update bootloader. However, it requires your existing bootloader version is at least 0.4.0 and only work with nRF52840 (not nRF52832).
- Use Arduino IDE: work with all Adafruit nRF52 boards and bootloader version, typo free but may not be the latest bootloader version due to the BSP release cycle.
- Use Command Line: work with all boards and bootloader version (including 3rd party one). This command line uses the back-end of the Arduino IDE method above.

---

## Use UF2

This is the fastest and safest way to update bootloader. However, it requires your existing bootloader is at least 0.4.0 and only work with nRF52840 (not nRF52832) since UF2 make use of USB MSC interface.

## Download update-bootloader UF2

You need a `.uf2` file containing the latest version of the bootloader. Use the correct link below for your board below to download it.

Latest `.uf2` of Feather Express  
nRF52840 bootloader

Latest `.uf2` of Circuit Playground  
Bluefruit nRF52840 bootloader

Latest `.uf2` of ItsyBitsy nRF52840  
bootloader

Latest `.uf2` of Adafruit CLUE  
bootloader

Latest `.uf2` of Feather Sense  
nRF52840 bootloader

## Enter Bootloader Mode

Double-click the Reset button on your board, and you will see the NeoPixel RGB LED turn green (identified by the arrow in the image). If it turns red, check the USB cable, try another USB port, etc.

Note: on nRF52840 USB Key with TinyUF2 (PID 5199) you need to hold its button while plugging into your PC.

## Drop & Drop UF2

You will see a new BOOT disk drive appear e.g FTNR840BOOT. Drag the downloaded `.uf2` file to FTNR840BOOT. The LED will flash. Then, the FTNR840BOOT drive will disappear. That's it, you have successfully update your board to the latest version.

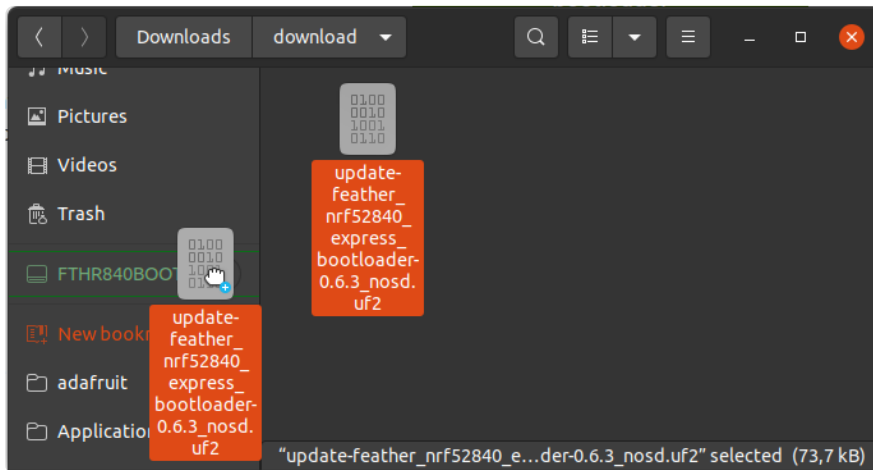

## Issues

If you download the wrong UF2 file for your board, dragging the file to the ...BOOT drive will close the drive but will not update the firmware (as it is the firmware for the wrong board). You can check the INFO\_UF2.TXT on the board and see if the firmware was updated (likely with the wrong UF2 file it was not).

If you cannot find the correct UF2 check all the files in [https://github.com/adafruit/Adafruit\\_nRF52\\_Bootloader/releases](https://github.com/adafruit/Adafruit_nRF52_Bootloader/releases) () for the correct UF2 (they all start with the word `update-boardname-bootloader-version.uf2` so scroll the list down to the files starting with u.

Non Adafruit board firmware updates can be found using this method also.

# Use Arduino IDE

Arduino IDE Burn Bootloader menu option will pick the correct bootloader binary for your selected board and prevent any command typos or other common errors.

Close the Serial Monitor before you click "Burn Bootloader". Afterwards, you shouldn't close the Arduino IDE, unplug the board, launch Serial Monitor etc ... to abort the process. There is a high chance it will brick your device! Do this with care and caution.

This is an advanced method: if your existing bootloader version is 0.4.0 or later, you can use the UF2 method, which is faster and safer.

Make sure no other program is attached to the serial port on the board, such as Mu, the Serial Monitor in Arduino, or a terminal program. Then, to start, select the correct board you are using under Tools -> Board

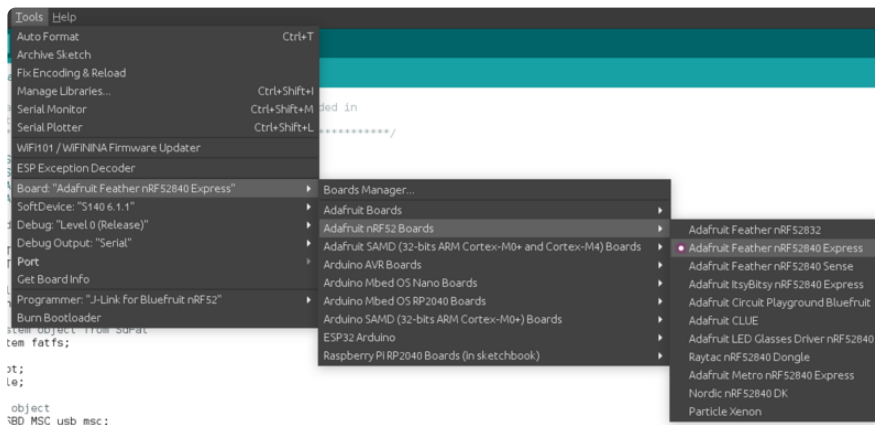

Then select "Bootloader DFU for Bluefruit nRF52" for Tools->Programmer

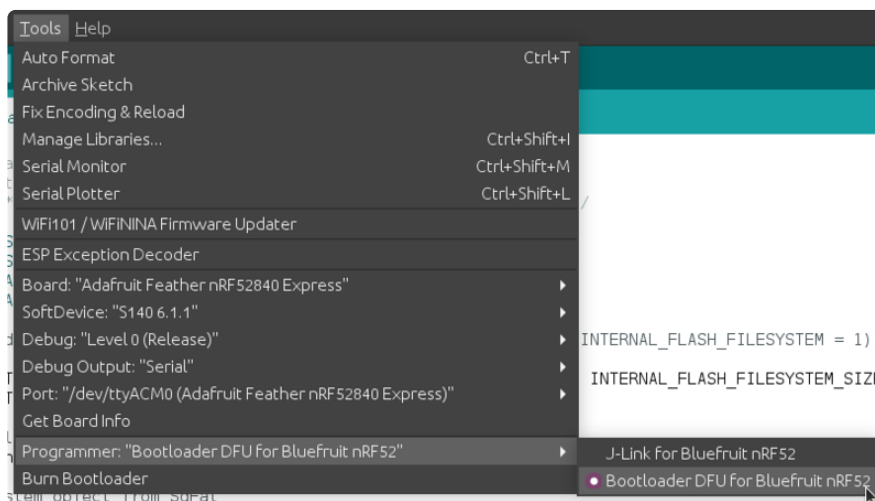



Drawbacks of this method are that you will need to install the Arduino IDE, and the bundled bootloader may not be the latest one. Check out the next page for a more advanced command line version.

---

## Use Command Line

This is advanced method: if your existing bootloader version is 0.4.0 or later, you can use the UF2 method, which is faster and safer.

## Download Bootloader Package

To update the bootloader, you need a `.zip` file containing the latest version of the bootloader. Use the link below to download it. Then unzip the `.zip` you downloaded.

Latest `.zip` of Feather nRF52840  
bootloader and associated files

## Download adafruit-nrfutil

You will also need the utility program "adafruit-nrfutil", which has slightly different names on different platforms.

On Linux, you can download and install `adafruit-nrfutil` by doing:

```
$ pip3 install --user adafruit-nrfutil
```

On MacOS, if you have `python3` and `pip3` installed, you can install via `pip3`, as above for Linux. Otherwise download `adafruit-nrfutil-macos` from this link:

adafruit-nrfutil-macos for MacOS

Then make it executable by doing:

```
chmod +x adafruit-nrfutil-macos
```

On Windows, download `adafruit-nrfutil.exe` from this link:

adafruit-nrfutil.exe (for Windows)

# Update Bootloader

To update the bootloader, first connect the board, and then double-click to get **NRF52 BOOT**. In the commands below, substitute the name of the **.zip** file you downloaded for file given there.

On Linux, run this command:

```
adafruit-nrfutil --verbose dfu serial --package  
feather_nrf52840_express_bootloader-0.2.9_s140_6.1.1.zip -p /dev/ttyACM0 -b 115200  
--singlebank --touch 1200
```

On MacOS, find out the device name for the connected board, by doing:

```
ls /dev/cu.*
```

The device name will be something like **/dev/cu.usbmodem411**. Use this command, substituting the device name you've discovered. If you are running it other than where you downloaded **adafruit-nrfutil-macos**, change the path to the command accordingly. If you installed it via pip3, it's just called **adafruit-nrfutil**, and it should be in your PATH.

```
./adafruit-nrfutil-macos --verbose dfu serial --package  
feather_nrf52840_express_bootloader-0.2.9_s140_6.1.1.zip -p /dev/cu.usbmodem411 -b  
115200 --singlebank --touch 1200
```

On Windows, use this command, in the folder where you downloaded the other two files above. You'll need to specify the correct COM port, instead of **COMxx**. Look in Device Manager for the name of the COM port (it will be listed as a "USB Serial Device" on Windows 10) after you have double-clicked the reset button.

```
adafruit-nrfutil.exe --verbose dfu serial --package  
feather_nrf52840_express_bootloader-0.2.9_s140_6.1.1.zip --port COMxx -b 115200 --  
singlebank --touch 1200
```

Once done, click the reset button again - the bootloader will be running!

# Guided Tour

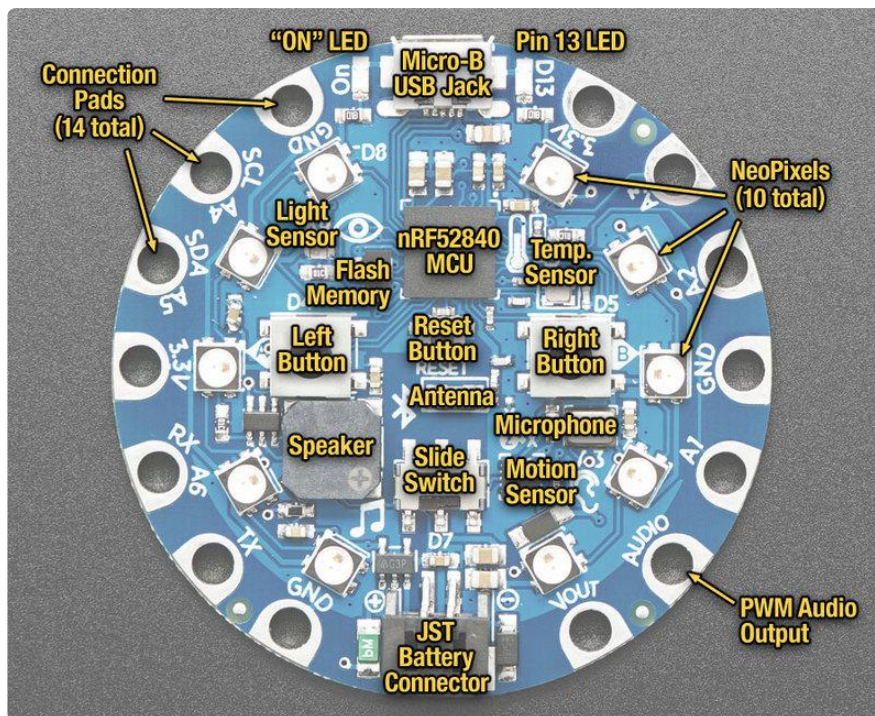

Let us take you on a tour of your Circuit Playground Bluefruit, which we'll shorten to C PB.

## Power and Data

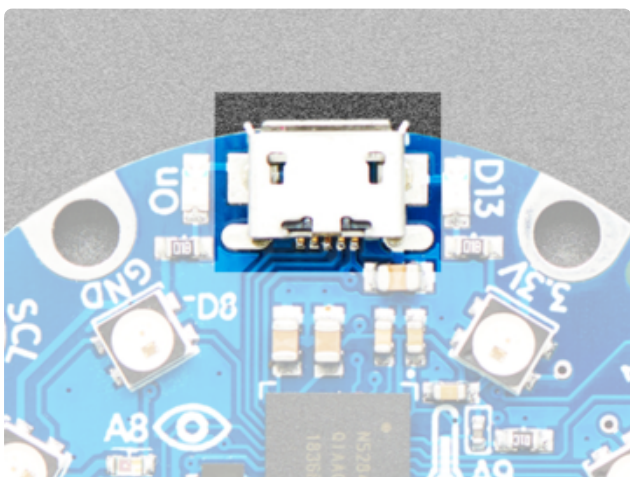

### Micro B USB connector

This is at the top of the board. We went with the tried and true micro-B USB connector for power and/or USB communication (bootloader, serial, HID, etc). Use with any computer with a standard data/sync cable.

## JST Battery Input

This is at the bottom of the board. You can take your CPB anywhere and power it from an external battery. This pin can take up 6V DC input, and has reverse-polarity, over-current and thermal protections. The circuitry inside will use either the battery input power or USB power, safely switching from one to the other. If both are connected, it will use whichever has the higher voltage. Works great with a Lithium Polymer battery or our 3xAAA battery packs with a JST connector on the end. There is no built in battery charging (so that you can use Alkaline or Lithium batteries safely)

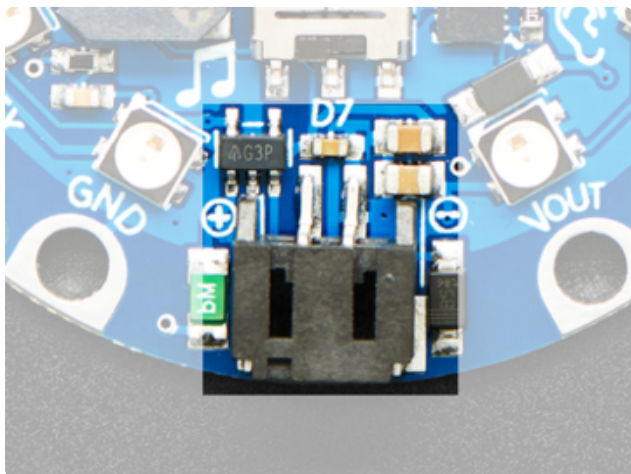

## Alligator/Croc Clip Pads

To make it super-easy to connect to the microcontroller, we have 14 connection pads. You can solder to them, use alligator/croc clips, sew with conductive thread, even use small metal screws!

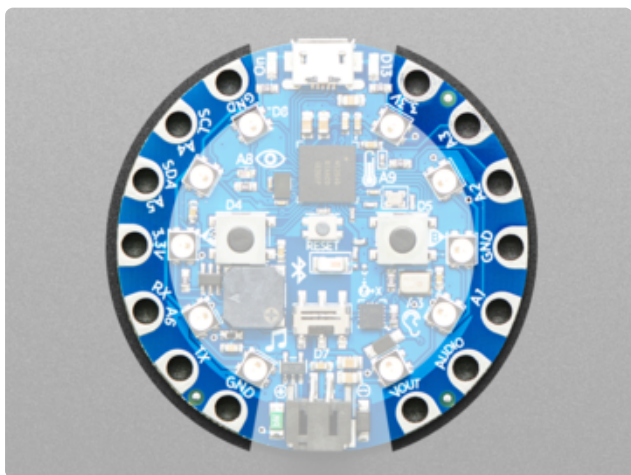

Of the 14 pads, you get a wide range of power pins, I2C, UART, Analog In, Digital In/Out, PWM, and Analog Out.

Some of them can even sense the touch of your finger!

See the next pinouts page for more details!

# Microchips

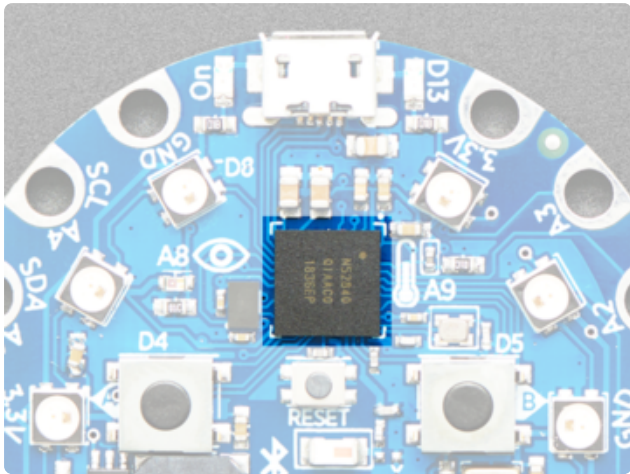

The brains of the operation is the nRF52840 Cortex M4 processor with Bluetooth Low Energy support. It sits at the top center and is what allows you to run CircuitPython or Arduino!

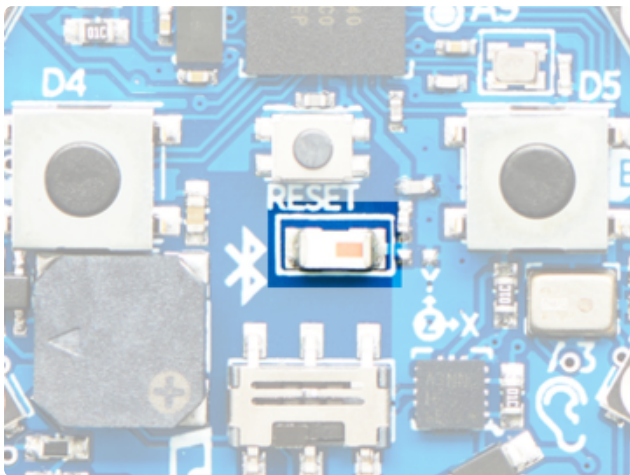

The Bluetooth antenna for the nRF52840 Bluetooth functionality is located in the center of the board. If you run into issues with Bluetooth range, make sure there's nothing near the antenna that might interfere, such as metallic surfaces!

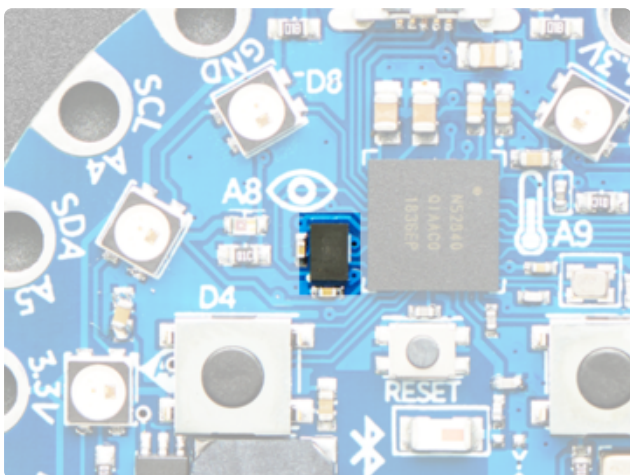

We have added a storage chip, called SPI Flash. This is a very, very small disk drive, only 2 MB large. You can use this in Arduino or CircuitPython to store files. In CircuitPython this is where all your code lives, and what you see when you use the CIRCUITPY drive on your computer.

# LEDs

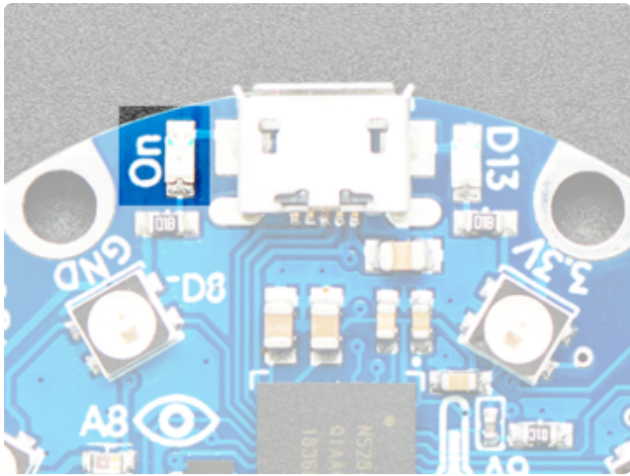

## Green ON LED

To the left of the USB connector. This LED lets you know that the CPB is powered on. If it's lit, power is good! If it's dim, flickering or off, there's a power problem and you will have problems. You can't disable this light, but you can cover it with electrical tape if you want to make it black.

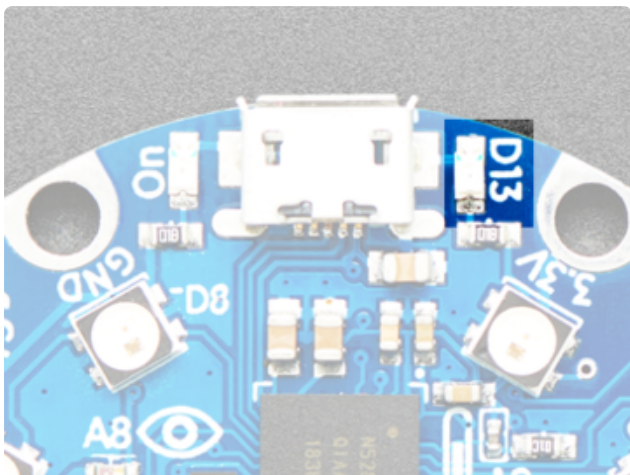

## Red #13 LED

To the right of the USB connector. This LED does double duty. Its connected with a series resistor to the digital #13 GPIO pin. It pulses nicely when the CPB is in bootloader mode, and its also handy for when you want an indicator LED. Many first projects blink this LED to prove that programming worked.

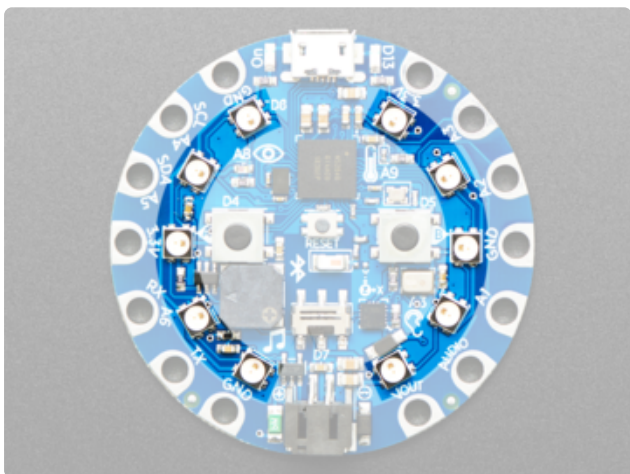

## 10 x Color NeoPixel LED

The ten LEDs surrounding the outer edge of the boards are all full color, RGB LEDs, each one can be set to any color in the rainbow. Great for beautiful lighting effects! The NeoPixels will also help you know when the bootloader is running (they will turn green) or if it failed to initialize USB when connected to a computer (they will turn red).

# Speaker

The CPB includes a speaker. It's not going to compete with your HiFi stereo, but it can play simple songs and tones.

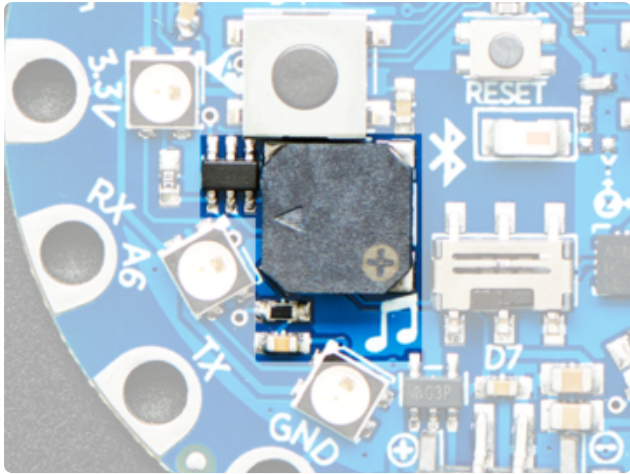

The speaker is the squarish gray chunk on the bottom left of the board. There is a small class D amplifier connected to the speaker so it can get quite loud! Note: it won't sound good if too loud, so some experimentation may be necessary

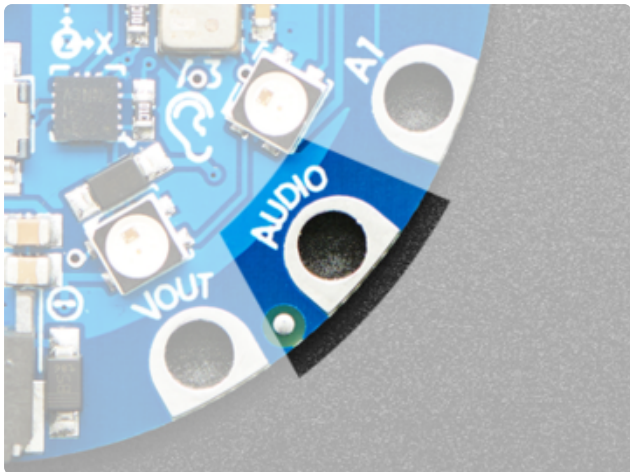

The amplifier is connected to the PWM output AUDIO pin -- this pin is also available on one of the connection pads in the lower right.

If you do not want the internal speaker to make noise, you can turn it off using the shutdown control on pin #11

## Sensors

The Circuit Playground Bluefruit has a large number of sensor inputs that let you add all sorts of interactivity to your project.

## Light Sensor

There is an analog light sensor, [part number ALS-PT19](#) ([link](#)), in the top left part of the board. This can be used to detect ambient light, with similar spectral response to the human eye.

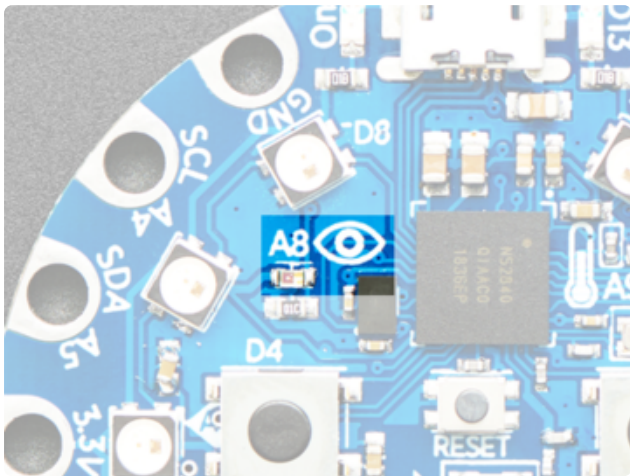

This sensor is connect to analog pin A8. With Arduino, it will read between 0 and 1023 with higher values corresponding to higher light levels. A reading of about 300 is common for most indoor light levels. In CircuitPython, the returned range is scaled differently and is 0 to 65535.

With some clever code, you can use this as a color sensor or even a pulse sensor!

## Temperature Sensor

There is an NTC thermistor (Murata NCP15XH103F03RC) that we use for temperature sensing. While it isn't an all-in-one temperature sensor, with linear output, it's easy to calculate the temperature based on the analog voltage on analog pin A9. There's a 10K resistor connected to it as a pull down.

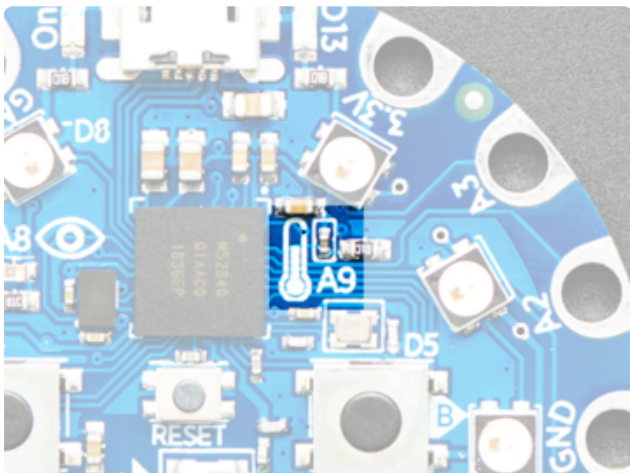

## Microphone Audio Sensor

A MEMS microphone can be used to detect audio levels and even perform basic FFT functions. Instead of an analog microphone, that requires an external op-amp and level management, we've decided to go with a PDM microphone. This is a digital mic, and is a lot smaller and less expensive! You will have to use the CircuitPython/Arduino support libraries to read the audio volume, you cannot read it like an analog voltage

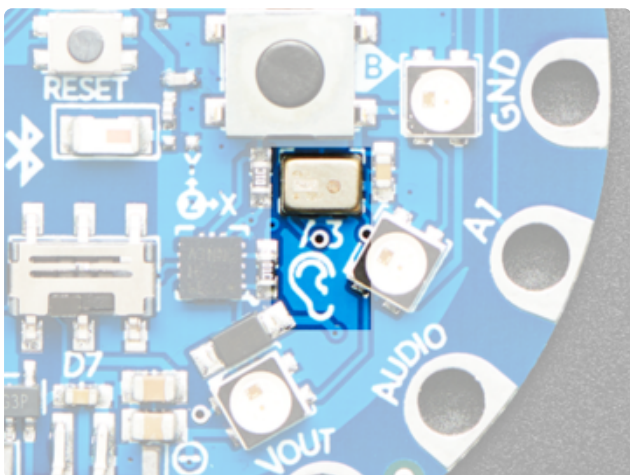

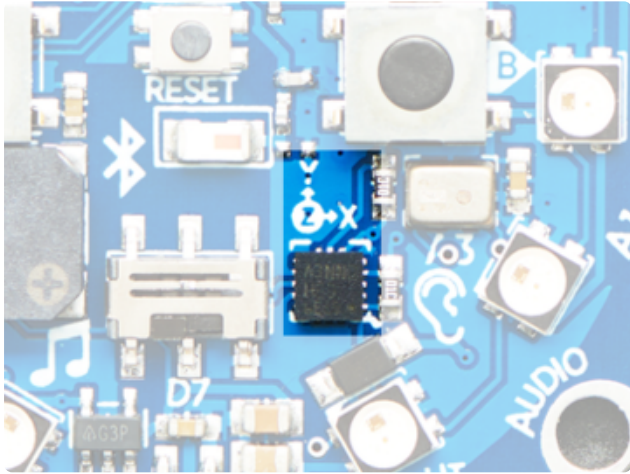

## Motion Sensor

We can sense motion with an accelerometer. This sensor detects acceleration which means it can be used to detect when its being moved around, as well as gravitational pull in order to detect orientation.

The LIS3DH 3-axis XYZ accelerometer can be used to detect tilt, gravity, motion, as well as 'tap' and 'double tap' strikes on the board. The LIS3DH is connected to an internal I2C pinset (not the same as the ones on the pads) and has an optional interrupt output on digital pin D24.

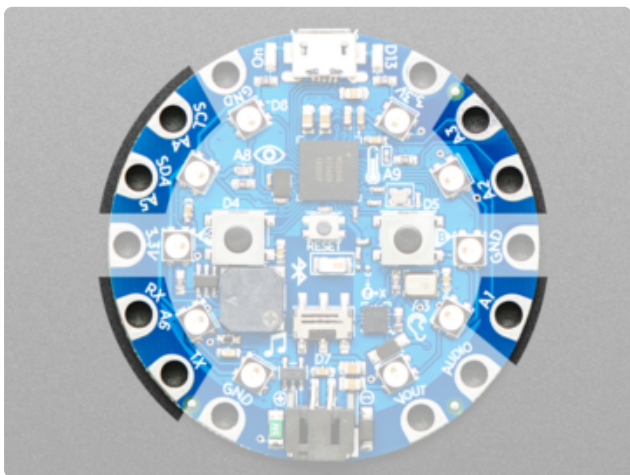

## Capacitive Touch

The CPB has capacitive touch capabilities. This is a great way to sense human touch without additional components. Even animals will work if it's directly touching their skin!

On the Bluefruit you get seven capacitive touch pads: A1 - A6 and TX. Capacitive touch is supported in both CircuitPython and Arduino!

## Switches & Buttons

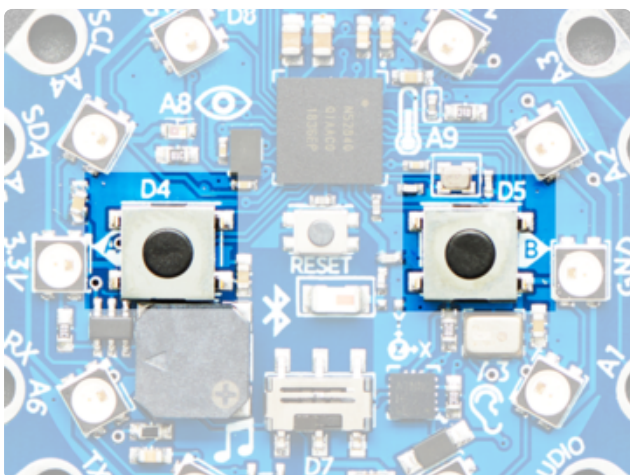

There are two large A and B buttons, connected to digital D4 (Left) and D5 (Right) each. These are unconnected when not pressed, and connected to 3.3V when pressed, so they read HIGH. Set the pins D4 (BUTTON\_A in CircuitPython) and D5 (BUTTON\_B in CircuitPython) to use an internal pull-down resistor when reading these pins so they will read LOW when not pressed.

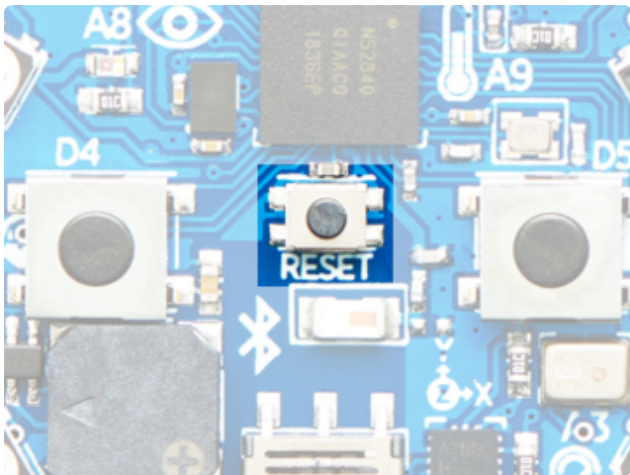

This small button in the center of the board is for Resetting the board. You can use this button to restart or reset the CPB.

If using Arduino or CircuitPython, press this button once to reset, double-click to enter the bootloader manually.

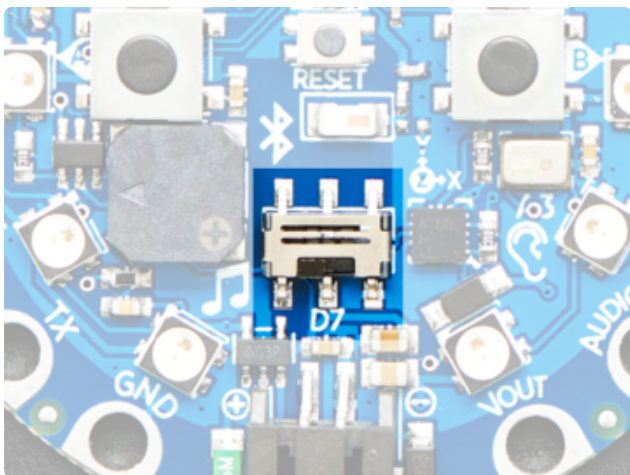

There is a single slide switch near the center bottom of the Circuit Playground Bluefruit. It is connected to digital D7. The switch is unconnected when slid to the left and connected to ground when slid to the right. We set pin D7 to use an internal pull-up resistor so that the switch will read HIGH when slid to the left and LOW when slid to the right.

This is not an on-off switch, but you can use code to have this switch control how you want your project to behave

Note that you need to use an internal pull-up for the slide switch, but an internal pull-down for the push-buttons.

---

## Pinouts

Despite having only 14 pads with 8 general purpose I/O pins available, there are a lot of possibilities with Circuit Playground Bluefruit. We went over all the internals in the last page. On this page we'll go through each pin/pad to explain what you can do with it.

Other than the Audio pad, no external I/O pads are shared with internal sensors/ devices, so you do not need to worry about 'conflicting' pins or interactions!

# Adafruit Circuit Playground Bluefruit

<https://www.adafruit.com/product/4333>

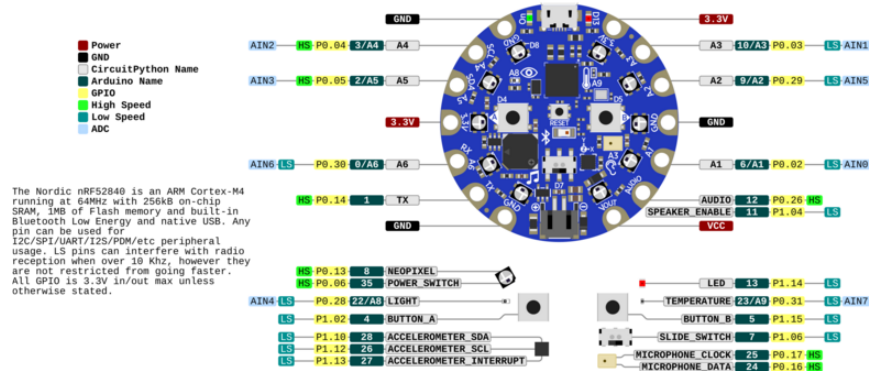

[Click here to view a PDF version of the pinout diagram \(\)](#)

## Power Pads

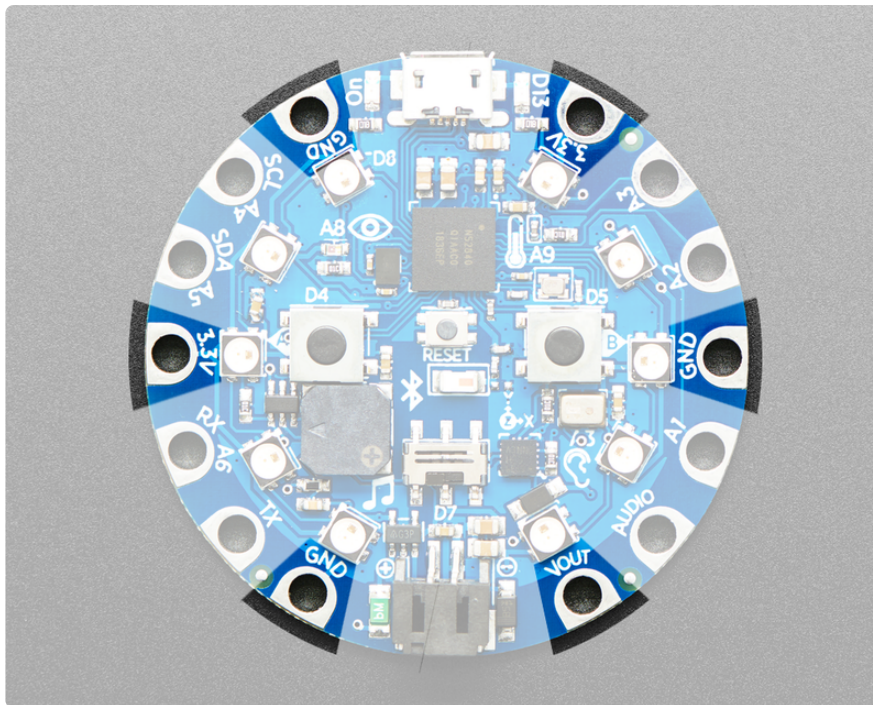

There are 6 power pads available, equally spaced around the perimeter.

- GND - there are 3 x Ground pads. They are all connected together, and are all the signal/power ground connections
- 3.3V - there are two 3.3 Volt output pads. They are connected to the output of the onboard regulator. The regulator can provide about 500mA max, but that includes all the built in parts too! So you should roughly budget about 300mA available for your usage (450mA if you are not using the onboard NeoPixels)
- Vout - there is one Voltage Output pad. This is a special power pad, it will be connected to either the USB power or the battery input, whichever has the

higher voltage. This output does not connect to the regulator so you can draw as much current as your USB port / Battery can provide. There is a resettable fuse on this pin, so you can draw about 500mA continuous, and 1 Amp peak before it will trip. If the fuse trips, just wait a minute and it will automatically reset

If you want to connect chips, sensors, and low power electronics that requires 3.3V clean power, use the 3.3V pads.

If you want to connect servos, NeoPixels, DotStars or other high power electronics that are OK up to 5V, use the Vout pad.

## Input/Output Pads

Next we will cover the 8 GPIO (General Purpose Input Output) pins! For reference you may want to also check out the datasheet-reference in the downloads section for the core nRF52840. We picked pins that have a lot of capabilities.

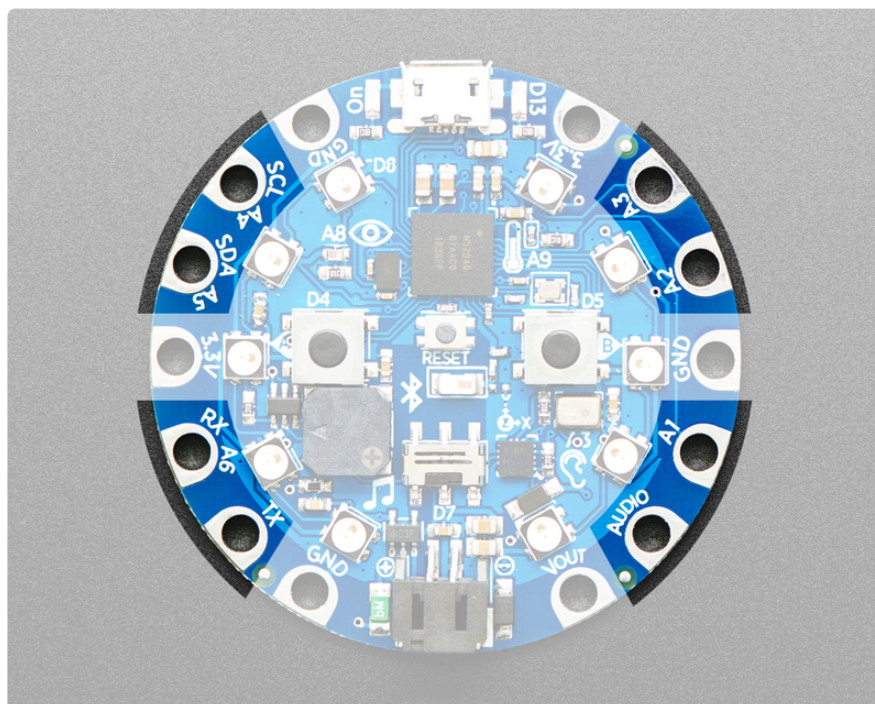

### Common to all pads

All the GPIO pads can be used as digital inputs, digital outputs, for LEDs, buttons and switches. In addition, A1-A6 can be used as analog inputs (12-bit ADC) (TX and Audio can not!). All but Audio can be used for capacitive touch. All pads can also be used as hardware interrupt inputs.

Each pad can provide up to ~20mA of current. Don't connect a motor or other high-power component directly to the pins! [Instead, use a transistor to power the DC motor on/off \(\)](#)

All of the GPIO pads are 3.3V output level, and should not be used with 5V inputs. In general, most 5V devices are OK with 3.3V output though.

Other than Audio, which is shared with the speaker, all of the pads are completely 'free' pins, they are not used by the USB connection, LEDs, sensors, etc so you never have to worry about interfering with them when programming.

## Each Pin!

Let's start with Audio which is in the bottom right corner, and work our way counter-clockwise. Because the nRF52840 is flexible with PWM pins, you can make any of the pins PWM outputs

- Audio (a.k.a D12) - This is a designated pin that is OK with high speed PWM signal, so it's great for playing basic audio clips - it's also connected to the little speaker on board. In can be digital I/O, but if you do that it will interfere with the built-in speaker. This is the one pin that cannot be used for capacitive touch.
- A1 / D6 - This pin can be digital I/O, or analog input and can be capacitive touch sensor
- A2 / D9 - This pin can be digital I/O, or analog input and can be capacitive touch sensor
- A3 / D10 - This pin can be digital I/O, or analog input and can be capacitive touch sensor
- A4 / SCL / D3 - This pin can be digital I/O, or analog input. This pin is also the designated I2C SCL pin, and can be capacitive touch sensor
- A5 / SDA / D2 - This pin can be digital I/O, or analog input. This pin is also the designated I2C SDA pin, and can be capacitive touch sensor
- A6 / RX / D0 - This pin can be digital I/O, or analog Input. This pin has PWM output, Serial Receive, and can be capacitive touch sensor
- TX / D1 - This pin can be digital I/O. This pin has PWM output, Serial Transmit, and can be capacitive touch sensor

## Internally Used Pins!

These are the names of the pins that are used for built in sensors and such! CircuitPython has more user friendly names available as well for some pins with

things like buttons and LEDs on them - these are included in parentheses where applicable. Both names will work in CircuitPython!

- D4 (BUTTON\_A) - Left Button A
  - D5 (BUTTON\_B) - Right Button B
  - D7 (SLIDE\_SWITCH)- Slide Switch
  - D8 (NEOPIXEL) - Built-in 10 NeoPixels
  - D11 (SPEAKER\_SHUTDOWN; in CircuitPython, use `board.SPEAKER_ENABLE`) - Power control to the speaker amp, pulled up by default. Set to output and LOW to turn off the speaker and save power.
  - D12 / AUDIO (SPEAKER) - Speaker analog output
  - D13 - Red LED
  - A8 (LIGHT) - Light Sensor
  - A9 (TEMPERATURE) - Temperature Sensor
- 
- D24 - PDM mic data
  - D25 - PDM mic clock
  - D26 - Internal I2C SCL for accelerometer
  - D27 - Accelerometer interrupt
  - D28 - Internal I2C SDA for accelerometer
  - D29 ~ D34 - QSPI FLASH chip pins
  - D35 - Sensor + NeoPixel power pin, default is pulled LOW (to enable power to sensors and NeoPixel). Set to output and HIGH to turn off power to NeoPixels and light/thermistor/microphone. Accelerometer does not get turned off (so you can do shake-to-wake). Speaker shutdown pin is different as well

## Debug Interface



There are three debug pads on the back of the Circuit Playground Bluefruit below the "GROUND" in the PLAYGROUND label.

Left to right they are:

SWCLK  
SWDIO  
RESET

---

# What is CircuitPython?

CircuitPython is a programming language designed to simplify experimenting and learning to program on low-cost microcontroller boards. It makes getting started easier than ever with no upfront desktop downloads needed. Once you get your board set up, open any text editor, and get started editing code. It's that simple.



## CircuitPython is based on Python

Python is the fastest growing programming language. It's taught in schools and universities. It's a high-level programming language which means it's designed to be easier to read, write and maintain. It supports modules and packages which means it's easy to reuse your code for other projects. It has a built in interpreter which means there are no extra steps, like compiling, to get your code to work. And of course, Python is Open Source Software which means it's free for anyone to use, modify or improve upon.

CircuitPython adds hardware support to all of these amazing features. If you already have Python knowledge, you can easily apply that to using CircuitPython. If you have no previous experience, it's really simple to get started!



## Why would I use CircuitPython?

CircuitPython is designed to run on microcontroller boards. A microcontroller board is a board with a microcontroller chip that's essentially an itty-bitty all-in-one computer. The board you're holding is a microcontroller board! CircuitPython is easy to use because all you need is that little board, a USB cable, and a computer with a USB connection. But that's only the beginning.

Other reasons to use CircuitPython include:

- You want to get up and running quickly. Create a file, edit your code, save the file, and it runs immediately. There is no compiling, no downloading and no uploading needed.
- You're new to programming. CircuitPython is designed with education in mind. It's easy to start learning how to program and you get immediate feedback from the board.
- Easily update your code. Since your code lives on the disk drive, you can edit it whenever you like, you can also keep multiple files around for easy experimentation.
- The serial console and REPL. These allow for live feedback from your code and interactive programming.
- File storage. The internal storage for CircuitPython makes it great for data-logging, playing audio clips, and otherwise interacting with files.
- Strong hardware support. CircuitPython has builtin support for microcontroller hardware features like digital I/O pins, hardware buses (UART, I2C, SPI), audio I/O, and other capabilities. There are also many libraries and drivers for sensors, breakout boards and other external components.
- It's Python! Python is the fastest-growing programming language. It's taught in schools and universities. CircuitPython is almost-completely compatible with Python. It simply adds hardware support.

This is just the beginning. CircuitPython continues to evolve, and is constantly being updated. Adafruit welcomes and encourages feedback from the community, and incorporate it into the development of CircuitPython. That's the core of the open source concept. This makes CircuitPython better for you and everyone who uses it!

---

# CircuitPython on Circuit Playground Bluefruit

## Install or Update CircuitPython

Follow this quick step-by-step to install or update CircuitPython on your Circuit Playground Bluefruit.

Download the latest version of  
CircuitPython for this board via  
[circuitpython.org](http://circuitpython.org)

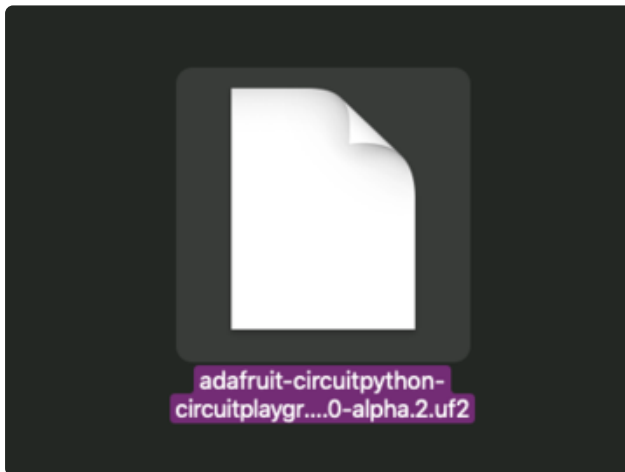

Click the link above and download the latest UF2 file

Download and save it to your Desktop (or wherever is handy)

Plug your Circuit Playground Bluefruit into your computer using a known-good data-capable USB cable.

A lot of people end up using charge-only USB cables and it is very frustrating! So make sure you have a USB cable you know is good for data sync.

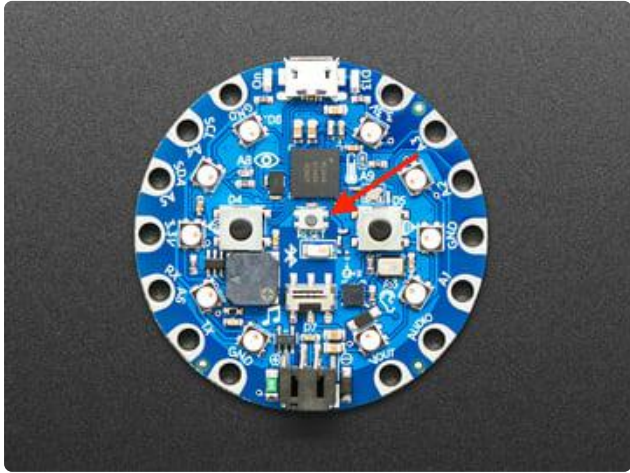

Double-click the small Reset button in the middle of the CPB (indicated by the red arrow in the image). The ten NeoPixel LEDs will all turn red, and then will all turn green. If they turn all red and stay red, check the USB cable, try another USB port, etc. The little red LED next to the USB connector will pulse red - this is ok!

If double-clicking doesn't work the first time, try again. Sometimes it can take a few tries to get the rhythm right!

(If double-clicking doesn't do it, try a single-click!)

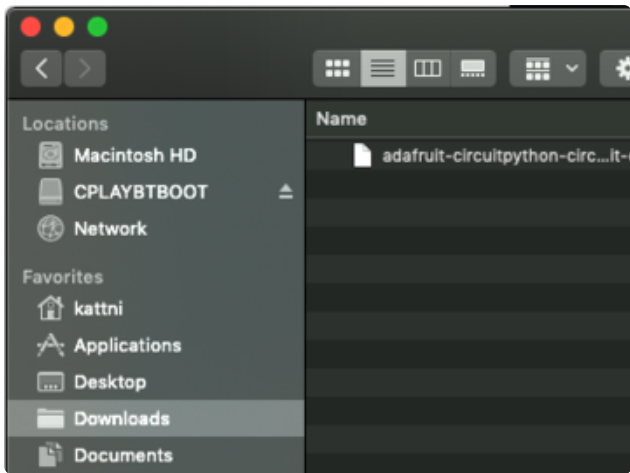

You will see a new disk drive appear called CPLAYBTBOOT.

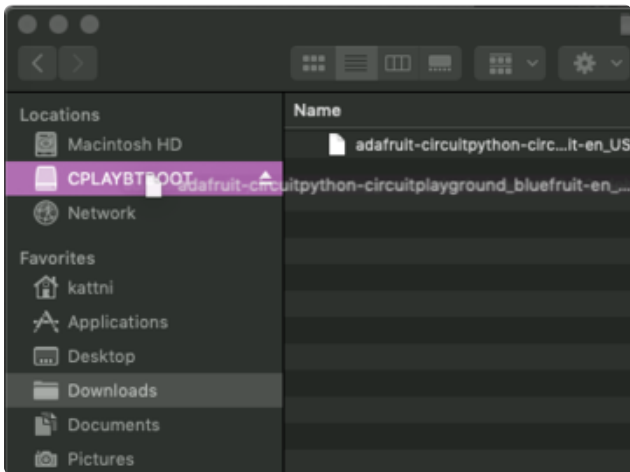

Drag the adafruit\_circuitpython\_etc.uf2 file to CPLAYBTBOOT.

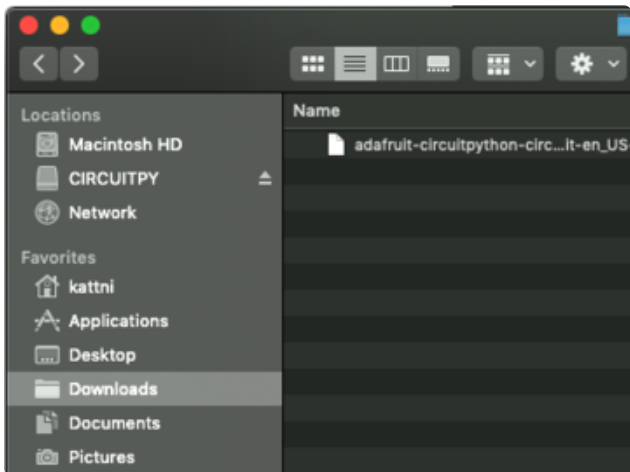

The LEDs will turn red. Then, the CPLAYBTBOOT drive will disappear and a new disk drive called CIRCUITPY will appear.

That's it, you're done! :)

---

## Circuit Playground Bluefruit CircuitPython Libraries

The Circuit Playground Bluefruit is packed full of features like Bluetooth and NeoPixel LEDs. Now that you have CircuitPython installed on your Circuit Playground Bluefruit, you'll need to install a base set of CircuitPython libraries to use the features of the board with CircuitPython.

Follow these steps to get the necessary libraries installed.

## Installing CircuitPython Libraries on Circuit Playground Bluefruit

If you do not already have a lib folder on your CIRCUITPY drive, create one now.

Then, download the CircuitPython library bundle that matches your version of CircuitPython from [CircuitPython.org](https://circuitpython.org).

Download the latest library bundle  
from [circuitpython.org](https://circuitpython.org)

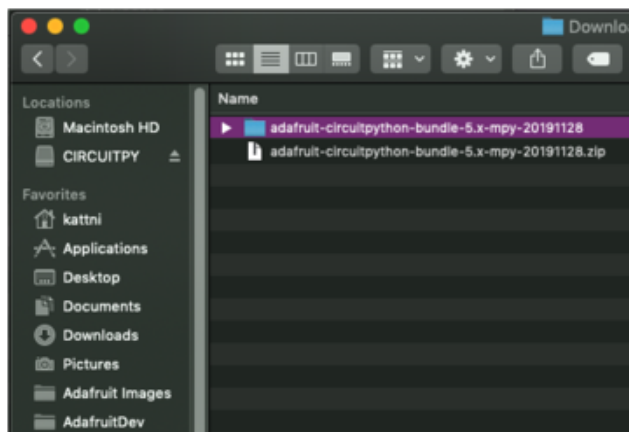

The bundle download as a .zip file. Extract the file. Open the resulting folder.

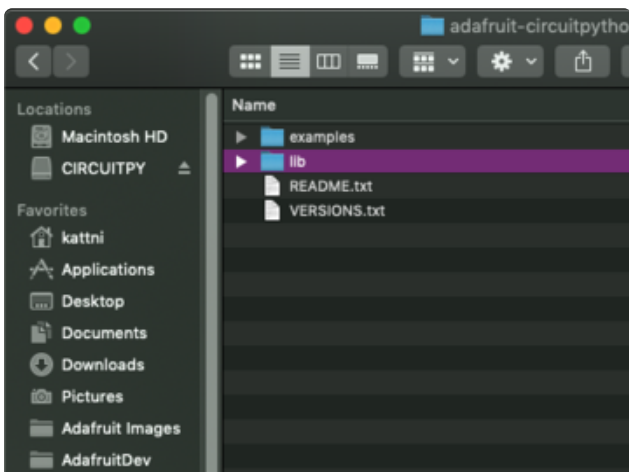

Open the lib folder found within.

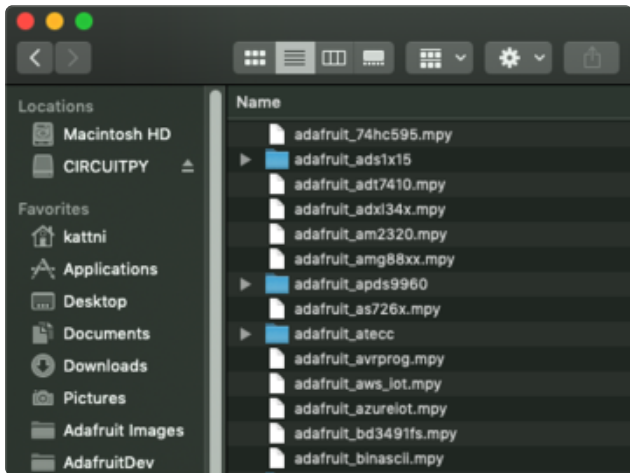

Once inside, you'll find a lengthy list of folders and .mpy files. To install a CircuitPython library, you drag the file or folder from the bundle lib folder to the lib folder on your CIRCUIPTY drive.

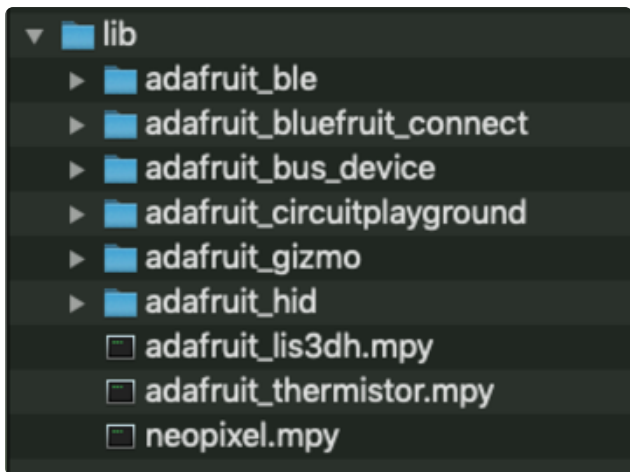

Copy the following folders and files from the bundle lib folder to the lib folder on your CIRCUIPTY drive:

adafruit\_ble  
 adafruit\_bluefruit\_connect  
 adafruit\_bus\_device  
 adafruit\_circuitplayground  
 adafruit\_gizmo  
 adafruit\_hid  
 adafruit\_lis3dh.mpy  
 adafruit\_thermistor.mpy  
 neopixel.mpy

Your lib folder should look like the image on the left.

Now you're all set to use CircuitPython with the features of the Circuit Playground Bluefruit!

## Getting Started with BLE and CircuitPython Guides

- [Getting Started with CircuitPython and Bluetooth Low Energy \(\)](#) - Get started with CircuitPython, the Adafruit nRF52840 and the Bluefruit LE Connect app.
- [BLE Light Switch with Feather nRF52840 and Crickit \(\)](#) - Control a robot finger from across the room to flip on and off the lights!
- [Color Remote with Circuit Playground Bluefruit \(\)](#) - Mix NeoPixels wirelessly with a Bluetooth LE remote control!

- [MagicLight Bulb Color Mixer with Circuit Playground Bluefruit \(\)](#) - Mix colors on a MagicLight Bulb wirelessly with a Bluetooth LE remote control.
- [Bluetooth Turtle Bot with CircuitPython and Crickit \(\)](#) - Build your own Bluetooth controlled turtle rover!
- [Wooden NeoPixel Xmas Tree \(\)](#) - Cut a Christmas tree of wood and mount some NeoPixels in the tree to create a festive yuletide light display.
- [Bluefruit TFT Gizmo ANCS Notifier for iOS \(\)](#) - Circuit Playground Bluefruit displays your iOS notification icons so you know when there's fresh activity!
- [Bluefruit Playground Hide and Seek \(\)](#) - Use Circuit Playground Bluefruit devices to create a colorful signal strength-based proximity detector!
- [Snow Globe with Circuit Playground Bluefruit \(\)](#) - Make your own festive (or creatively odd!) snow globe with custom lighting effects and Bluetooth control.
- [Bluetooth Controlled NeoPixel Lightbox \(\)](#) - Great for tracing and writing, this lightbox lets you adjust color and brightness with your phone.
- [Circuit Playground Bluefruit NeoPixel Animation and Color Remote Control \(\)](#) - Control NeoPixel colors and animation remotely over Bluetooth with the Circuit Playground Bluefruit!
- [Circuit Playground Bluetooth Cauldron \(\)](#) - Build a Bluetooth Controlled Light Up Cauldron.
- [NeoPixel Badge Lanyard with Bluetooth LE \(\)](#) - Light up your convention badge and control colors with your phone!
- [CircuitPython BLE Controlled NeoPixel Hat \(\)](#) - Wireless control NeoPixels on your wearables!
- [Bluefruit nRF52 Feather Learning Guide \(\)](#) - Get started now with our most powerful Bluefruit board yet!
- [CircusPython: Jump through Hoops with CircuitPython Bluetooth LE \(\)](#) - Blinka jumps through a ring of fire, controlled via Bluetooth LE and the Bluefruit LE Connect app!
- [A CircuitPython BLE Remote Control On/Off Switch \(\)](#) - Make a remote control on/off switch for a computer with CircuitPython and BLE.
- [NeoPixel Infinity Cube \(\)](#) - Build a 3D printed, Bluetooth controlled Mirrored Acrylic and NeoPixel Infinity cube.
- [CircuitPython BLE Crickit Rover \(\)](#) - Purple Robot with Feather nRF52840 and Crickit plus NeoPixel underlighting!
- [Circuit Playground Bluefruit Pumpkin with Lights and Sounds \(\)](#) - Add the Circuit Playground Bluefruit and STEMMA speaker to an inexpensive plastic pumpkin.
- [No-Solder LED Disco Tie with Bluetooth \(\)](#) - Build an LED tie controlled by Bluetooth LE.
- [Bluetooth Remote Control for the Lego Droid Developer Kit \(\)](#) - Reinvigorating the Lego Star Wars Droid Developer Kit with an Adafruit powered remote control using Bluetooth LE.

---

# Installing the Mu Editor

Mu is a simple code editor that works with the Adafruit CircuitPython boards. It's written in Python and works on Windows, MacOS, Linux and Raspberry Pi. The serial console is built right in so you get immediate feedback from your board's serial output!

Mu is our recommended editor - please use it (unless you are an experienced coder with a favorite editor already!).

## Download and Install Mu

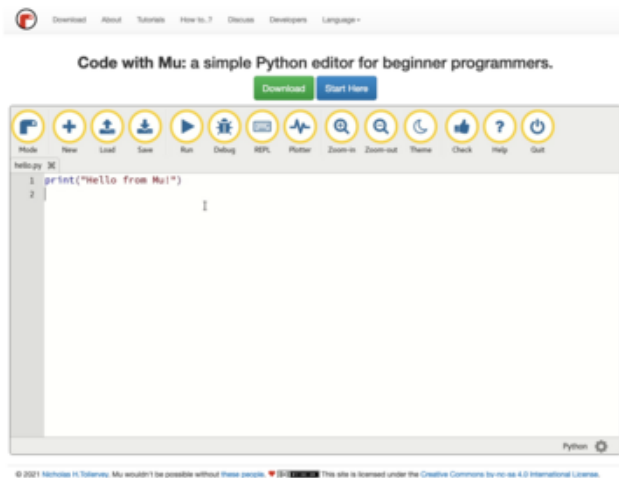

Download Mu from <https://codewith.mu> ().

Click the Download link for downloads and installation instructions.

Click Start Here to find a wealth of other information, including extensive tutorials and and how-to's.

Windows users: due to the nature of MSI installers, please remove old versions of Mu before installing the latest version.

## Starting Up Mu

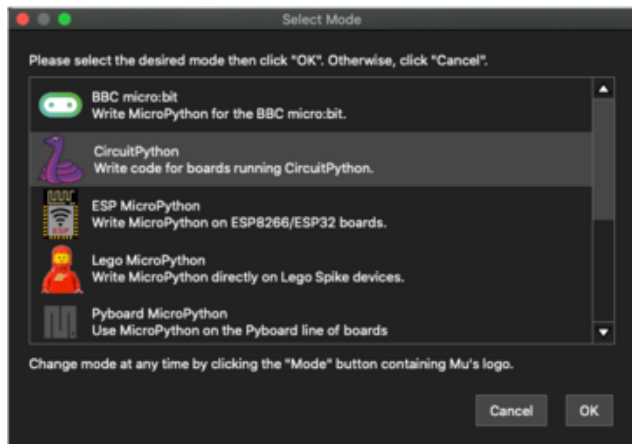

The first time you start Mu, you will be prompted to select your 'mode' - you can always change your mind later. For now please select CircuitPython!

The current mode is displayed in the lower right corner of the window, next to the "gear" icon. If the mode says "Microbit" or something else, click the Mode button in the upper left, and then choose "CircuitPython" in the dialog box that appears.

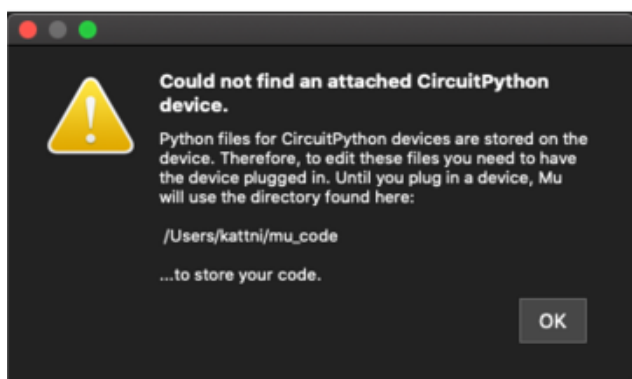

Mu attempts to auto-detect your board on startup, so if you do not have a CircuitPython board plugged in with a CIRCUITPY drive available, Mu will inform you where it will store any code you save until you plug in a board.

To avoid this warning, plug in a board and ensure that the CIRCUITPY drive is mounted before starting Mu.

## Using Mu

You can now explore Mu! The three main sections of the window are labeled below; the button bar, the text editor, and the serial console / REPL.



Now you're ready to code! Let's keep going...

## Creating and Editing Code

One of the best things about CircuitPython is how simple it is to get code up and running. This section covers how to create and edit your first CircuitPython program.

To create and edit code, all you'll need is an editor. There are many options. Adafruit strongly recommends using Mu! It's designed for CircuitPython, and it's really simple and easy to use, with a built in serial console!

If you don't or can't use Mu, there are a number of other editors that work quite well. The [Recommended Editors page \(\)](#) has more details. Otherwise, make sure you do "Eject" or "Safe Remove" on Windows or "sync" on Linux after writing a file if you aren't using Mu. (This is not a problem on MacOS.)

## Creating Code

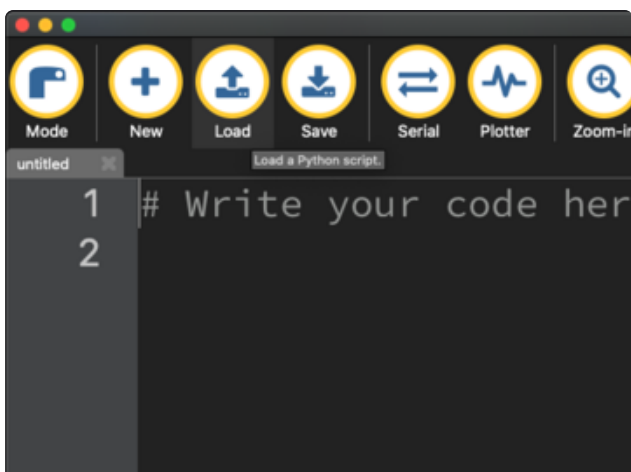

Installing CircuitPython generates a code.py file on your CIRCUITPY drive. To begin your own program, open your editor, and load the code.py file from the CIRCUITPY drive.

If you are using Mu, click the Load button in the button bar, navigate to the CIRCUITPY drive, and choose code.py.

Copy and paste the following code into your editor:

```
import board
import digitalio
import time

led = digitalio.DigitalInOut(board.LED)
led.direction = digitalio.Direction.OUTPUT

while True:
    led.value = True
    time.sleep(0.5)
    led.value = False
    time.sleep(0.5)
```

The KB2040, QT Py and the Trinkeys do not have a built-in little red LED! There is an addressable RGB NeoPixel LED. The above example will NOT work on the KB2040, QT Py or the Trinkeys!

If you're using a KB2040, QT Py or a Trinkey, please download the [NeoPixel blink example](#) ().

The NeoPixel blink example uses the onboard NeoPixel, but the time code is the same. You can use the linked NeoPixel Blink example to follow along with this guide page.

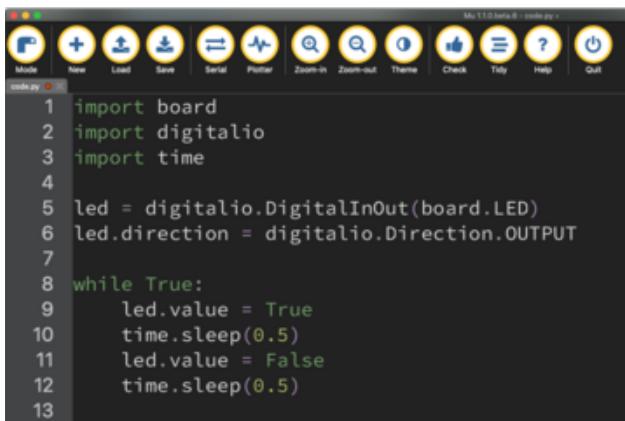
A screenshot of a code editor window. The editor has a dark background and a toolbar at the top with icons for file operations (New, Load, Save), editing (Undo, Redo), and other functions (Serial, Printer, Zoom, Theme, Check, Tidy, Help, Quit). The code is displayed in a monospaced font with line numbers on the left. The code is as follows:

```
1 import board
2 import digitalio
3 import time
4
5 led = digitalio.DigitalInOut(board.LED)
6 led.direction = digitalio.Direction.OUTPUT
7
8 while True:
9     led.value = True
10    time.sleep(0.5)
11    led.value = False
12    time.sleep(0.5)
13
```

It will look like this. Note that under the `while True:` line, the next four lines begin with four spaces to indent them, and they're indented exactly the same amount. All the lines before that have no spaces before the text.

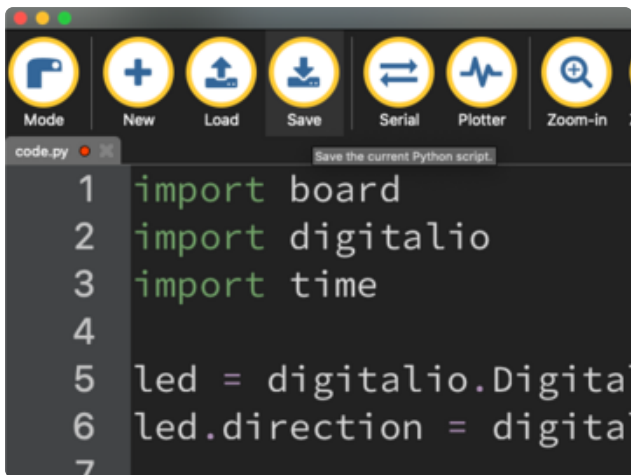

Save the code.py file on your CIRCUITPY drive.

The little LED should now be blinking. Once per half-second.

Congratulations, you've just run your first CircuitPython program!

On most boards you'll find a tiny red LED.

On the ItsyBitsy nRF52840, you'll find a tiny blue LED.

On QT Py M0, QT Py RP2040, and the Trinkey series, you will find only an RGB NeoPixel LED.

## Editing Code

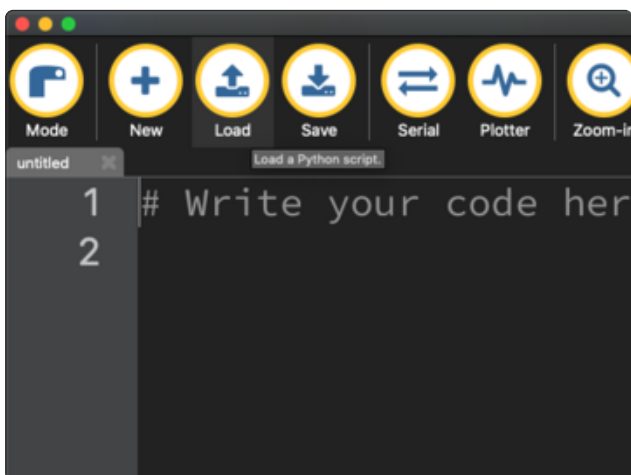

To edit code, open the code.py file on your CIRCUITPY drive into your editor.

Make the desired changes to your code. Save the file. That's it!

Your code changes are run as soon as the file is done saving.

There's one warning before you continue...

**Don't click reset or unplug your board!**

The CircuitPython code on your board detects when the files are changed or written and will automatically re-start your code. This makes coding very fast because you save, and it re-runs. If you unplug or reset the board before your computer finishes writing the file to your board, you can corrupt the drive. If this happens, you may lose the code you've written, so it's important to backup your code to your computer regularly.

There are a couple of ways to avoid filesystem corruption.

1. Use an editor that writes out the file completely when you save it.

Check out the [Recommended Editors page \(\)](#) for details on different editing options.

If you are dragging a file from your host computer onto the CIRCUITPY drive, you still need to do step 2. Eject or Sync (below) to make sure the file is completely written.

2. Eject or Sync the Drive After Writing

If you are using one of our not-recommended-editors, not all is lost! You can still make it work.

On Windows, you can Eject or Safe Remove the CIRCUITPY drive. It won't actually eject, but it will force the operating system to save your file to disk. On Linux, use the sync command in a terminal to force the write to disk.

You also need to do this if you use Windows Explorer or a Linux graphical file manager to drag a file onto CIRCUITPY.

---

## Oh No I Did Something Wrong and Now The CIRCUITPY Drive Doesn't Show Up!!!

Don't worry! Corrupting the drive isn't the end of the world (or your board!). If this happens, follow the steps found on the [Troubleshooting \(\)](#) page of every board guide to get your board up and running again.

---

## Back to Editing Code...

Now! Let's try editing the program you added to your board. Open your code.py file into your editor. You'll make a simple change. Change the first `0.5` to `0.1`. The code should look like this:

```
import board
import digitalio
import time

led = digitalio.DigitalInOut(board.LED)
led.direction = digitalio.Direction.OUTPUT

while True:
    led.value = True
    time.sleep(0.1)
    led.value = False
    time.sleep(0.5)
```

Leave the rest of the code as-is. Save your file. See what happens to the LED on your board? Something changed! Do you know why?

You don't have to stop there! Let's keep going. Change the second `0.5` to `0.1` so it looks like this:

```
while True:
    led.value = True
    time.sleep(0.1)
    led.value = False
    time.sleep(0.1)
```

Now it blinks really fast! You decreased the both time that the code leaves the LED on and off!

Now try increasing both of the `0.1` to `1`. Your LED will blink much more slowly because you've increased the amount of time that the LED is turned on and off.

Well done! You're doing great! You're ready to start into new examples and edit them to see what happens! These were simple changes, but major changes are done using the same process. Make your desired change, save it, and get the results. That's really all there is to it!

## Naming Your Program File

CircuitPython looks for a code file on the board to run. There are four options: code.txt, code.py, main.txt and main.py. CircuitPython looks for those files, in that order, and then runs the first one it finds. While code.py is the recommended name for your code

file, it is important to know that the other options exist. If your program doesn't seem to be updating as you work, make sure you haven't created another code file that's being read instead of the one you're working on.

---

## Connecting to the Serial Console

One of the staples of CircuitPython (and programming in general!) is something called a "print statement". This is a line you include in your code that causes your code to output text. A print statement in CircuitPython (and Python) looks like this:

```
print("Hello, world!")
```

This line in your code.py would result in:

```
Hello, world!
```

However, these print statements need somewhere to display. That's where the serial console comes in!

The serial console receives output from your CircuitPython board sent over USB and displays it so you can see it. This is necessary when you've included a print statement in your code and you'd like to see what you printed. It is also helpful for troubleshooting errors, because your board will send errors and the serial console will display those too.

The serial console requires an editor that has a built in terminal, or a separate terminal program. A terminal is a program that gives you a text-based interface to perform various tasks.

## Are you using Mu?

If so, good news! The serial console is built into Mu and will autodetect your board making using the serial console really really easy.

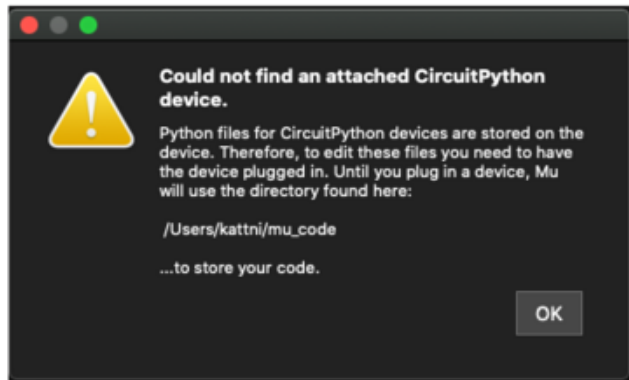

First, make sure your CircuitPython board is plugged in.

If you open Mu without a board plugged in, you may encounter the error seen here, letting you know no CircuitPython board was found and indicating where your code will be stored until you plug in a board.

If you are using Windows 7, make sure you installed the drivers ([link](#)).

Once you've opened Mu with your board plugged in, look for the Serial button in the button bar and click it.

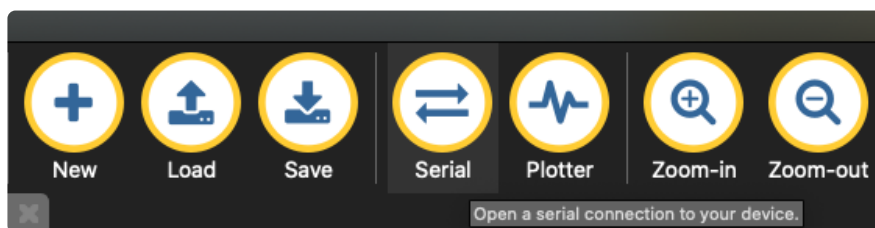

The Mu window will split in two, horizontally, and display the serial console at the bottom.



If nothing appears in the serial console, it may mean your code is done running or has no print statements in it. Click into the serial console part of Mu, and press CTRL+D to reload.

## Serial Console Issues or Delays on Linux

If you're on Linux, and are seeing multi-second delays connecting to the serial console, or are seeing "AT" and other gibberish when you connect, then the `modemmanager` service might be interfering. Just remove it; it doesn't have much use unless you're still using dial-up modems.

To remove `modemmanager`, type the following command at a shell:

```
sudo apt purge modemmanager
```

## Setting Permissions on Linux

On Linux, if you see an error box something like the one below when you press the Serial button, you need to add yourself to a user group to have permission to connect to the serial console.



On Ubuntu and Debian, add yourself to the dialout group by doing:

```
sudo adduser $USER dialout
```

After running the command above, reboot your machine to gain access to the group. On other Linux distributions, the group you need may be different. See the [Advanced Serial Console on Linux \(\)](#) for details on how to add yourself to the right group.

## Using Something Else?

If you're not using Mu to edit, are using or if for some reason you are not a fan of its built in serial console, you can run the serial console from a separate program.

Windows requires you to download a terminal program. [Check out the Advanced Serial Console on Windows page for more details. \(\)](#)

MacOS has Terminal built in, though there are other options available for download. [Check the Advanced Serial Console on Mac page for more details. \(\)](#)

Linux has a terminal program built in, though other options are available for download. [Check the Advanced Serial Console on Linux page for more details. \(\)](#)

Once connected, you'll see something like the following.

```
Auto-reload is on. Simply save files over USB to run them or enter REPL to disable.
code.py output:
Hello, world!

Code done running.

Press any key to enter the REPL. Use CTRL-D to reload.
```

## Interacting with the Serial Console

Once you've successfully connected to the serial console, it's time to start using it.

The code you wrote earlier has no output to the serial console. So, you're going to edit it to create some output.

Open your code.py file into your editor, and include a `print` statement. You can print anything you like! Just include your phrase between the quotation marks inside the parentheses. For example:

```
import board
import digitalio
import time

led = digitalio.DigitalInOut(board.LED)
led.direction = digitalio.Direction.OUTPUT

while True:
    print("Hello, CircuitPython!")
    led.value = True
    time.sleep(1)
    led.value = False
    time.sleep(1)
```

Save your file.

Now, let's go take a look at the window with our connection to the serial console.

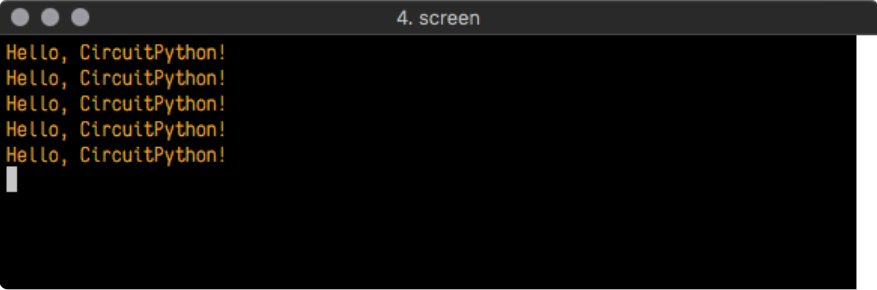

```
4. screen
Hello, CircuitPython!
Hello, CircuitPython!
Hello, CircuitPython!
Hello, CircuitPython!
Hello, CircuitPython!
```

Excellent! Our print statement is showing up in our console! Try changing the printed text to something else.

```
import board
import digitalio
import time
```

```

led = digitalio.DigitalInOut(board.LED)
led.direction = digitalio.Direction.OUTPUT

while True:
    print("Hello back to you!")
    led.value = True
    time.sleep(1)
    led.value = False
    time.sleep(1)

```

Keep your serial console window where you can see it. Save your file. You'll see what the serial console displays when the board reboots. Then you'll see your new change!

```

4. screen
Hello, CircuitPython!
Hello, CircuitPython!
Traceback (most recent call last):
  File "code.py", line 11, in <module>
KeyboardInterrupt:
soft reboot

Auto-reload is on. Simply save files over USB to run them or enter REPL to disable.
code.py output:
Hello back to you!
Hello back to you!

```

The **Traceback (most recent call last):** is telling you the last thing your board was doing before you saved your file. This is normal behavior and will happen every time the board resets. This is really handy for troubleshooting. Let's introduce an error so you can see how it is used.

Delete the **e** at the end of **True** from the line **led.value = True** so that it says **led.value = Tru**

```

import board
import digitalio
import time

led = digitalio.DigitalInOut(board.LED)
led.direction = digitalio.Direction.OUTPUT

while True:
    print("Hello back to you!")
    led.value = Tru
    time.sleep(1)
    led.value = False
    time.sleep(1)

```

Save your file. You will notice that your red LED will stop blinking, and you may have a colored status LED blinking at you. This is because the code is no longer correct and can no longer run properly. You need to fix it!

Usually when you run into errors, it's not because you introduced them on purpose. You may have 200 lines of code, and have no idea where your error could be hiding. This is where the serial console can help. Let's take a look!

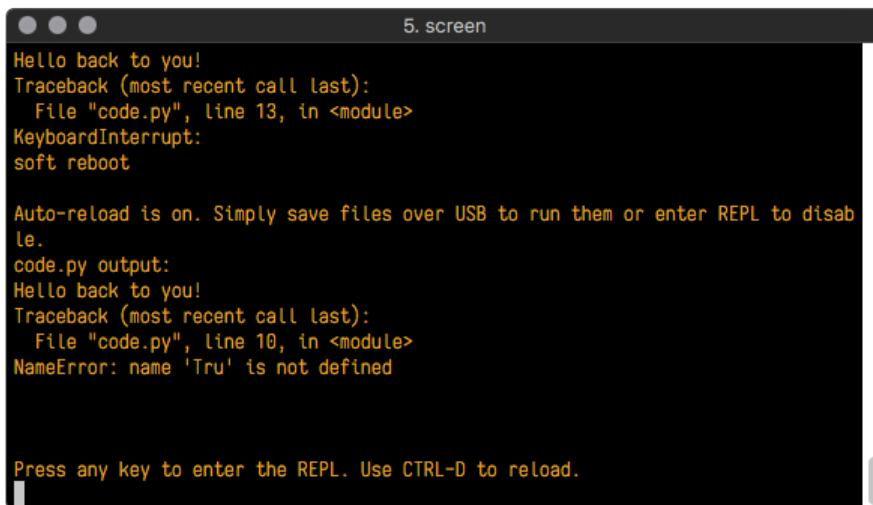

```
5. screen
Hello back to you!
Traceback (most recent call last):
  File "code.py", line 13, in <module>
KeyboardInterrupt:
soft reboot

Auto-reload is on. Simply save files over USB to run them or enter REPL to disable.
code.py output:
Hello back to you!
Traceback (most recent call last):
  File "code.py", line 10, in <module>
NameError: name 'Tru' is not defined

Press any key to enter the REPL. Use CTRL-D to reload.
```

The **Traceback (most recent call last):** is telling you that the last thing it was able to run was **line 10** in your code. The next line is your error: **NameError: name 'Tru' is not defined**. This error might not mean a lot to you, but combined with knowing the issue is on line 10, it gives you a great place to start!

Go back to your code, and take a look at line 10. Obviously, you know what the problem is already. But if you didn't, you'd want to look at line 10 and see if you could figure it out. If you're still unsure, try googling the error to get some help. In this case, you know what to look for. You spelled True wrong. Fix the typo and save your file.

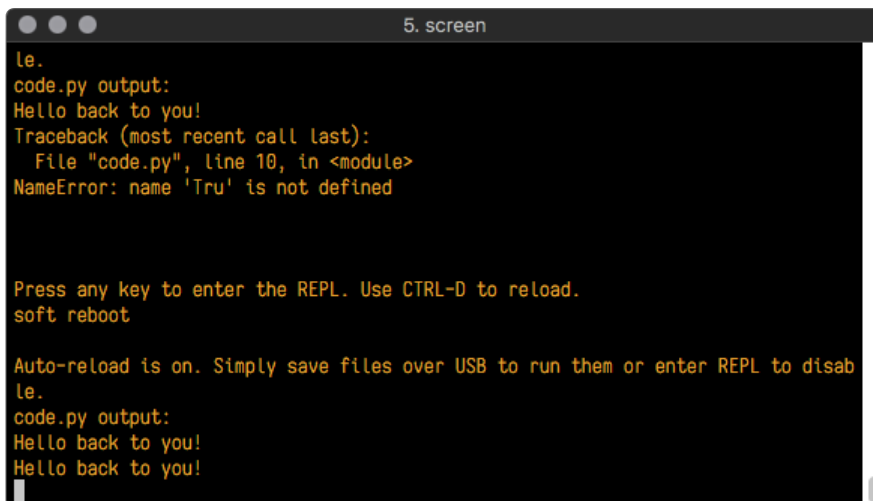

```
5. screen
le.
code.py output:
Hello back to you!
Traceback (most recent call last):
  File "code.py", line 10, in <module>
NameError: name 'Tru' is not defined

Press any key to enter the REPL. Use CTRL-D to reload.
soft reboot

Auto-reload is on. Simply save files over USB to run them or enter REPL to disable.
code.py output:
Hello back to you!
Hello back to you!
```

Nice job fixing the error! Your serial console is streaming and your red LED is blinking again.

The serial console will display any output generated by your code. Some sensors, such as a humidity sensor or a thermistor, receive data and you can use print

statements to display that information. You can also use print statements for troubleshooting, which is called "print debugging". Essentially, if your code isn't working, and you want to know where it's failing, you can put print statements in various places to see where it stops printing.

The serial console has many uses, and is an amazing tool overall for learning and programming!

---

## The REPL

The other feature of the serial connection is the Read-Evaluate-Print-Loop, or REPL. The REPL allows you to enter individual lines of code and have them run immediately. It's really handy if you're running into trouble with a particular program and can't figure out why. It's interactive so it's great for testing new ideas.

## Entering the REPL

To use the REPL, you first need to be connected to the serial console. Once that connection has been established, you'll want to press CTRL+C.

If there is code running, in this case code measuring distance, it will stop and you'll see **Press any key to enter the REPL. Use CTRL-D to reload.** Follow those instructions, and press any key on your keyboard.

The **Traceback (most recent call last):** is telling you the last thing your board was doing before you pressed Ctrl + C and interrupted it. The **KeyboardInterrupt** is you pressing CTRL+C. This information can be handy when troubleshooting, but for now, don't worry about it. Just note that it is expected behavior.

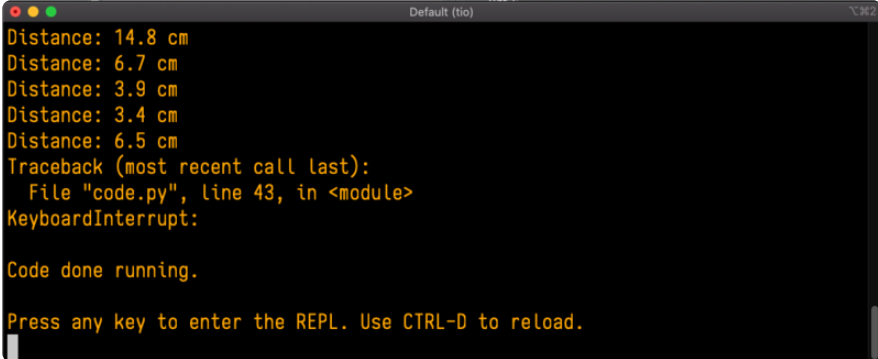

```
Distance: 14.8 cm
Distance: 6.7 cm
Distance: 3.9 cm
Distance: 3.4 cm
Distance: 6.5 cm
Traceback (most recent call last):
  File "code.py", line 43, in <module>
KeyboardInterrupt:
Code done running.
Press any key to enter the REPL. Use CTRL-D to reload.
```

If your code.py file is empty or does not contain a loop, it will show an empty output and **Code done running.** There is no information about what your board was doing before you interrupted it because there is no code running.

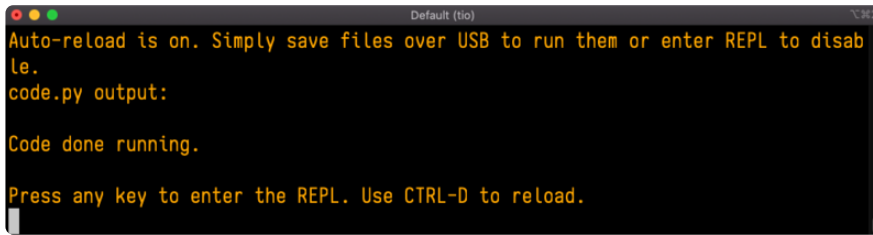

```
Default (tio)
Auto-reload is on. Simply save files over USB to run them or enter REPL to disable.
code.py output:

Code done running.

Press any key to enter the REPL. Use CTRL-D to reload.
```

If you have no code.py on your CIRCUITPY drive, you will enter the REPL immediately after pressing CTRL+C. Again, there is no information about what your board was doing before you interrupted it because there is no code running.

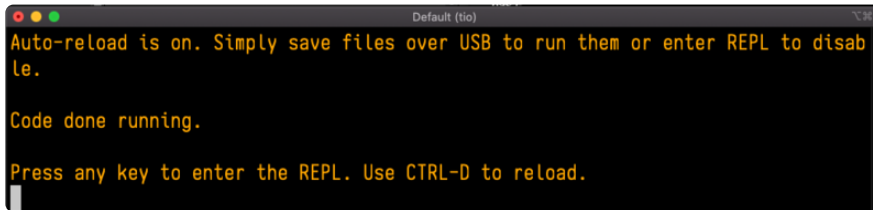

```
Default (tio)
Auto-reload is on. Simply save files over USB to run them or enter REPL to disable.

Code done running.

Press any key to enter the REPL. Use CTRL-D to reload.
```

Regardless, once you press a key you'll see a `>>>` prompt welcoming you to the REPL!

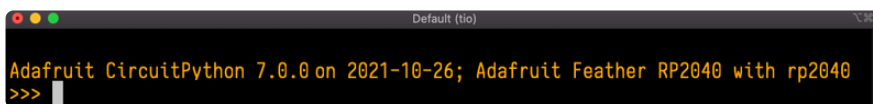

```
Default (tio)
Adafruit CircuitPython 7.0.0 on 2021-10-26; Adafruit Feather RP2040 with rp2040
>>> |
```

If you have trouble getting to the `>>>` prompt, try pressing Ctrl + C a few more times.

The first thing you get from the REPL is information about your board.



```
Adafruit CircuitPython 7.0.0 on 2021-10-26; Adafruit Feather RP2040 with rp2040
```

This line tells you the version of CircuitPython you're using and when it was released. Next, it gives you the type of board you're using and the type of microcontroller the board uses. Each part of this may be different for your board depending on the versions you're working with.

This is followed by the CircuitPython prompt.



```
>>>
```

## Interacting with the REPL

From this prompt you can run all sorts of commands and code. The first thing you'll do is run `help()`. This will tell you where to start exploring the REPL. To run code in the REPL, type it in next to the REPL prompt.

Type `help()` next to the prompt in the REPL.

```
Default (tio)
Adafruit CircuitPython 7.0.0 on 2021-10-26; Adafruit Feather RP2040 with rp2040
>>> help()
```

Then press enter. You should then see a message.

```
Default (tio)
Adafruit CircuitPython 7.0.0 on 2021-10-26; Adafruit Feather RP2040 with rp2040
>>> help()
Welcome to Adafruit CircuitPython 7.0.0!

Visit circuitpython.org for more information.

To list built-in modules type `help("modules")`.
>>>
```

First part of the message is another reference to the version of CircuitPython you're using. Second, a URL for the CircuitPython related project guides. Then... wait. What's this? `To list built-in modules type `help("modules")`.` Remember the modules you learned about while going through creating code? That's exactly what this is talking about! This is a perfect place to start. Let's take a look!

Type `help("modules")` into the REPL next to the prompt, and press enter.

```
>>> help("modules")
__main__      board          micropython   storage
_bleio        builtins       msgpack        struct
adafruit_bus_device  busio          neopixel_write  supervisor
adafruit_pixelbuf  collections    onewireio      synthio
aesio         countio        os              sys
alarm         digitalio     paralleldisplay terminalio
analogio      displayio     pulseio         time
array         errno         pwmio           touchio
atexit        fontio        gpio            traceback
audiobusio    framebufferio rainbowio        ulab
audiocore     gc            random          usb_cdc
audiomixer    getpass       re              usb_hid
audiomp3      imagecapture  rgbmatrix       usb_midi
audiopwmio    io            rotaryio        vectorio
binascii      json          rp2pio          watchdog
bitbangio     keypad        rtc
bitmaptools   math          sdcardio
bitops        microcontroller  sharpdisplay
Plus any modules on the filesystem
>>>
```

This is a list of all the core modules built into CircuitPython, including `board`. Remember, `board` contains all of the pins on the board that you can use in your code. From the REPL, you are able to see that list!

Type `import board` into the REPL and press enter. It'll go to a new prompt. It might look like nothing happened, but that's not the case! If you recall, the `import` statement simply tells the code to expect to do something with that module. In this case, it's telling the REPL that you plan to do something with that module.

```
>>> import board
>>>
```

Next, type `dir(board)` into the REPL and press enter.

```
>>> dir(board)
['_class_', '_name_', 'A0', 'A1', 'A2', 'A3', 'D0', 'D1', 'D10', 'D11', 'D12', 'D13',
'D24', 'D25', 'D4', 'D5', 'D6', 'D9', 'I2C', 'LED', 'MISO', 'MOSI', 'NEOPIXEL', 'RX', 'SCK',
', 'SCL', 'SDA', 'SPI', 'TX', 'UART', 'board_id']
>>>
```

This is a list of all of the pins on your board that are available for you to use in your code. Each board's list will differ slightly depending on the number of pins available. Do you see `LED`? That's the pin you used to blink the red LED!

The REPL can also be used to run code. Be aware that any code you enter into the REPL isn't saved anywhere. If you're testing something new that you'd like to keep, make sure you have it saved somewhere on your computer as well!

Every programmer in every programming language starts with a piece of code that says, "Hello, World." You're going to say hello to something else. Type into the REPL:

```
print("Hello, CircuitPython!")
```

Then press enter.

```
>>> print("Hello, CircuitPython")
Hello, CircuitPython
>>>
```

That's all there is to running code in the REPL! Nice job!

You can write single lines of code that run stand-alone. You can also write entire programs into the REPL to test them. Remember that nothing typed into the REPL is saved.

There's a lot the REPL can do for you. It's great for testing new ideas if you want to see if a few new lines of code will work. It's fantastic for troubleshooting code by entering it one line at a time and finding out where it fails. It lets you see what modules are available and explore those modules.

Try typing more into the REPL to see what happens!

Everything typed into the REPL is ephemeral. Once you reload the REPL or return to the serial console, nothing you typed will be retained in any memory space. So be sure to save any desired code you wrote somewhere else, or you'll lose it when you leave the current REPL instance!

# Returning to the Serial Console

When you're ready to leave the REPL and return to the serial console, simply press CT RL+D. This will reload your board and reenter the serial console. You will restart the program you had running before entering the REPL. In the console window, you'll see any output from the program you had running. And if your program was affecting anything visual on the board, you'll see that start up again as well.

You can return to the REPL at any time!

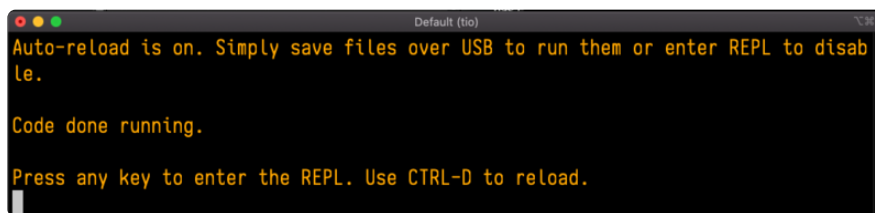

```
Default (tio)
Auto-reload is on. Simply save files over USB to run them or enter REPL to disable.

Code done running.

Press any key to enter the REPL. Use CTRL-D to reload.
```

---

## CircuitPython Libraries

As CircuitPython development continues and there are new releases, Adafruit will stop supporting older releases. Visit <https://circuitpython.org/downloads> to download the latest version of CircuitPython for your board. You must download the CircuitPython Library Bundle that matches your version of CircuitPython. Please update CircuitPython and then visit <https://circuitpython.org/libraries> to download the latest Library Bundle.

Each CircuitPython program you run needs to have a lot of information to work. The reason CircuitPython is so simple to use is that most of that information is stored in other files and works in the background. These files are called libraries. Some of them are built into CircuitPython. Others are stored on your CIRCUITPY drive in a folder called lib. Part of what makes CircuitPython so great is its ability to store code separately from the firmware itself. Storing code separately from the firmware makes it easier to update both the code you write and the libraries you depend.

Your board may ship with a lib folder already, it's in the base directory of the drive. If not, simply create the folder yourself. When you first install CircuitPython, an empty lib directory will be created for you.

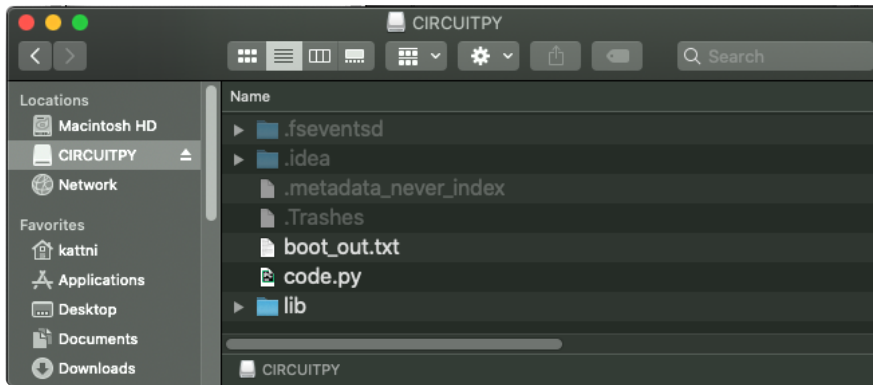

CircuitPython libraries work in the same way as regular Python modules so the [Python docs \(\)](#) are an excellent reference for how it all should work. In Python terms, you can place our library files in the lib directory because it's part of the Python path by default.

One downside of this approach of separate libraries is that they are not built in. To use them, one needs to copy them to the CIRCUITPY drive before they can be used. Fortunately, there is a library bundle.

The bundle and the library releases on GitHub also feature optimized versions of the libraries with the .mpy file extension. These files take less space on the drive and have a smaller memory footprint as they are loaded.

Due to the regular updates and space constraints, Adafruit does not ship boards with the entire bundle. Therefore, you will need to load the libraries you need when you begin working with your board. You can find example code in the guides for your board that depends on external libraries.

Either way, as you start to explore CircuitPython, you'll want to know how to get libraries on board.

## The Adafruit Learn Guide Project Bundle

The quickest and easiest way to get going with a project from the Adafruit Learn System is by utilising the Project Bundle. Most guides now have a Download Project Bundle button available at the top of the full code example embed. This button downloads all the necessary files, including images, etc., to get the guide project up and running. Simply click, open the resulting zip, copy over the right files, and you're good to go!

The first step is to find the Download Project Bundle button in the guide you're working on.

The Download Project Bundle button is only available on full demo code embedded from GitHub in a Learn guide. Code snippets will NOT have the button available.



Circuit Playground Express: Piano in the Key of Lime > Piano in the Key of Lime

## Piano in the Key of Lime

Now we'll take everything we learned and put it together!

Be sure to save your current code.py if you've changed anything you'd like to keep. Download the following file. Rename it to code.py and save it to your Circuit Playground Express.

[Download Project Bundle](#) [Copy Code](#)

```
# SPDX-FileCopyrightText: 2017 Kattni Rembor for Adafruit Industries
#
# SPDX-License-Identifier: MIT

from adafruit_circuitplayground import cp

while True:
    if cp.switch:
        print("Slide switch off!")
        cp.pixels.fill((0, 0, 0))
```

When you copy the contents of the Project Bundle to your CIRCUITPY drive, it will replace all the existing content! If you don't want to lose anything, ensure you copy your current code to your computer before you copy over the new Project Bundle content!

The Download Project Bundle button downloads a zip file. This zip contains a series of directories, nested within which is the code.py, any applicable assets like images or audio, and the lib/ folder containing all the necessary libraries. The following zip was downloaded from the Piano in the Key of Lime guide.

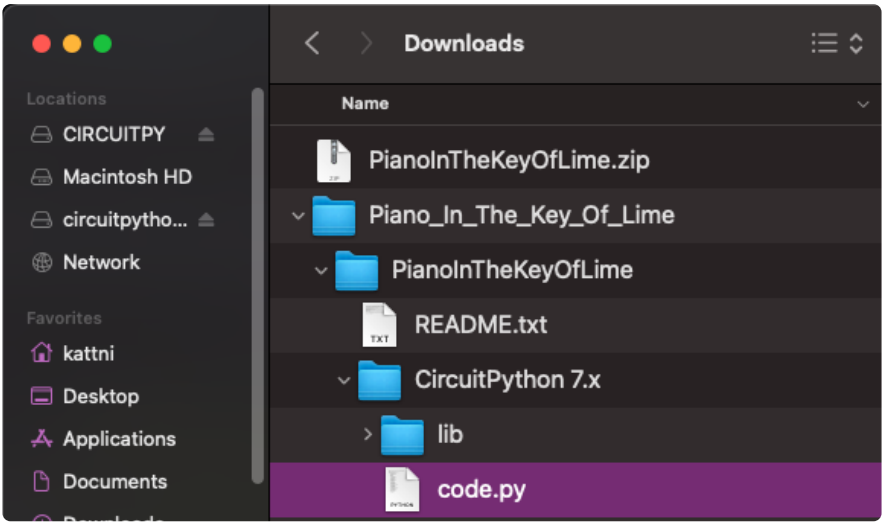

The Piano in the Key of Lime guide was chosen as an example. That guide is specific to Circuit Playground Express, and cannot be used on all boards. Do not

expect to download that exact bundle and have it work on your non-CPX microcontroller.

When you open the zip, you'll find some nested directories. Navigate through them until you find what you need. You'll eventually find a directory for your CircuitPython version (in this case, 7.x). In the version directory, you'll find the file and directory you need: `code.py` and `lib/`. Once you find the content you need, you can copy it all over to your CIRCUITPY drive, replacing any files already on the drive with the files from the freshly downloaded zip.

In some cases, there will be other files such as audio or images in the same directory as `code.py` and `lib/`. Make sure you include all the files when you copy things over!

Once you copy over all the relevant files, the project should begin running! If you find that the project is not running as expected, make sure you've copied ALL of the project files onto your microcontroller board.

That's all there is to using the Project Bundle!

## The Adafruit CircuitPython Library Bundle

Adafruit provides CircuitPython libraries for much of the hardware they provide, including sensors, breakouts and more. To eliminate the need for searching for each library individually, the libraries are available together in the Adafruit CircuitPython Library Bundle. The bundle contains all the files needed to use each library.

### Downloading the Adafruit CircuitPython Library Bundle

You can download the latest Adafruit CircuitPython Library Bundle release by clicking the button below. The libraries are being constantly updated and improved, so you'll always want to download the latest bundle.

Match up the bundle version with the version of CircuitPython you are running. For example, you would download the 6.x library bundle if you're running any version of CircuitPython 6, or the 7.x library bundle if you're running any version of CircuitPython 7, etc. If you mix libraries with major CircuitPython versions, you will get incompatible mpy errors due to changes in library interfaces possible during major version changes.

Click to visit [circuitpython.org](https://circuitpython.org) for the latest Adafruit CircuitPython Library Bundle

Download the bundle version that matches your CircuitPython firmware version. If you don't know the version, check the version info in `boot_out.txt` file on the CIRCUITPY drive, or the initial prompt in the CircuitPython REPL. For example, if you're running v7.0.0, download the 7.x library bundle.

There's also a py bundle which contains the uncompressed python files, you probably don't want that unless you are doing advanced work on libraries.

## The CircuitPython Community Library Bundle

The CircuitPython Community Library Bundle is made up of libraries written and provided by members of the CircuitPython community. These libraries are often written when community members encountered hardware not supported in the Adafruit Bundle, or to support a personal project. The authors all chose to submit these libraries to the Community Bundle make them available to the community.

These libraries are maintained by their authors and are not supported by Adafruit. As you would with any library, if you run into problems, feel free to file an issue on the GitHub repo for the library. Bear in mind, though, that most of these libraries are supported by a single person and you should be patient about receiving a response. Remember, these folks are not paid by Adafruit, and are volunteering their personal time when possible to provide support.

## Downloading the CircuitPython Community Library Bundle

You can download the latest CircuitPython Community Library Bundle release by clicking the button below. The libraries are being constantly updated and improved, so you'll always want to download the latest bundle.

Click for the latest CircuitPython Community Library Bundle release

The link takes you to the latest release of the CircuitPython Community Library Bundle on GitHub. There are multiple versions of the bundle available. Download the bundle version that matches your CircuitPython firmware version. If you don't know

the version, check the version info in boot\_out.txt file on the CIRCUITPY drive, or the initial prompt in the CircuitPython REPL. For example, if you're running v7.0.0, download the 7.x library bundle.

## Understanding the Bundle

After downloading the zip, extract its contents. This is usually done by double clicking on the zip. On Mac OSX, it places the file in the same directory as the zip.

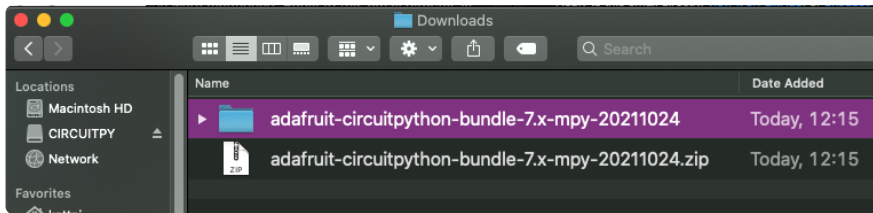

Open the bundle folder. Inside you'll find two information files, and two folders. One folder is the lib bundle, and the other folder is the examples bundle.

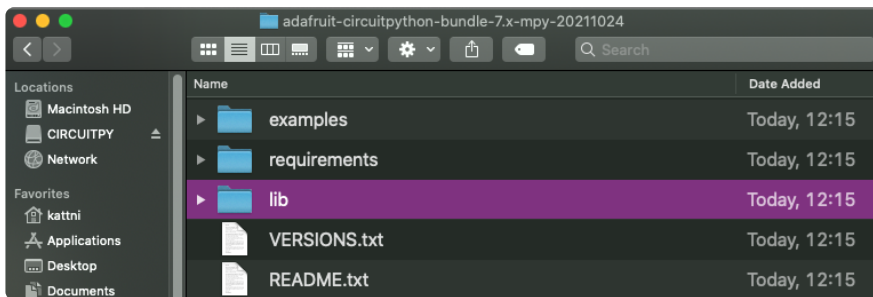

Now open the lib folder. When you open the folder, you'll see a large number of .mpy files, and folders.

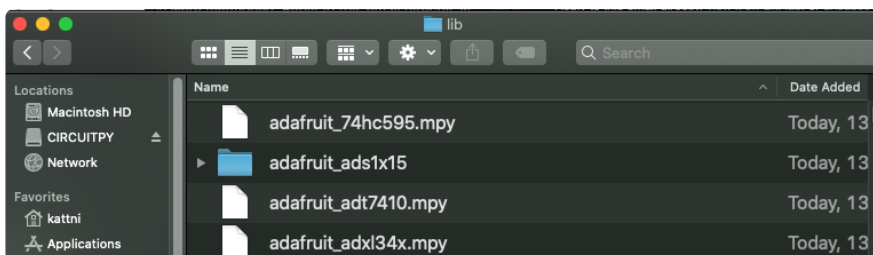

## Example Files

All example files from each library are now included in the bundles in an examples directory (as seen above), as well as an examples-only bundle. These are included for two main reasons:

- Allow for quick testing of devices.

- Provide an example base of code, that is easily built upon for individualized purposes.

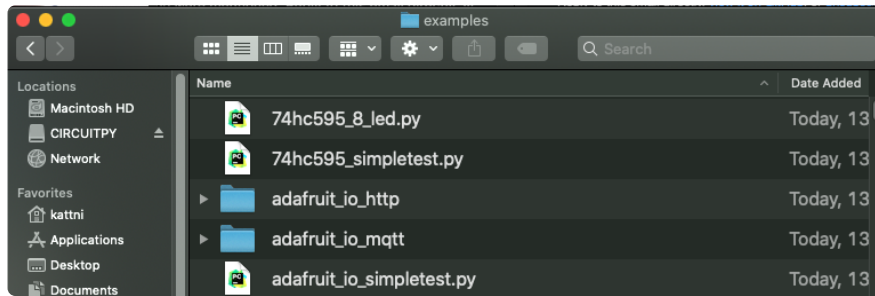

## Copying Libraries to Your Board

First open the lib folder on your CIRCUITPY drive. Then, open the lib folder you extracted from the downloaded zip. Inside you'll find a number of folders and .mpy files. Find the library you'd like to use, and copy it to the lib folder on CIRCUITPY.

If the library is a directory with multiple .mpy files in it, be sure to copy the entire folder to CIRCUITPY/lib.

This also applies to example files. Open the examples folder you extracted from the downloaded zip, and copy the applicable file to your CIRCUITPY drive. Then, rename it to code.py to run it.

If a library has multiple .mpy files contained in a folder, be sure to copy the entire folder to CIRCUITPY/lib.

## Understanding Which Libraries to Install

You now know how to load libraries on to your CircuitPython-compatible microcontroller board. You may now be wondering, how do you know which libraries you need to install? Unfortunately, it's not always straightforward. Fortunately, there is an obvious place to start, and a relatively simple way to figure out the rest. First up: the best place to start.

When you look at most CircuitPython examples, you'll see they begin with one or more `import` statements. These typically look like the following:

- `import library_or_module`

However, `import` statements can also sometimes look like the following:

- `from library_or_module import name`
- `from library_or_module.subpackage import name`
- `from library_or_module import name as local_name`

They can also have more complicated formats, such as including a `try` / `except` block, etc.

The important thing to know is that an `import` statement will always include the name of the module or library that you're importing.

Therefore, the best place to start is by reading through the `import` statements.

Here is an example import list for you to work with in this section. There is no setup or other code shown here, as the purpose of this section involves only the import list.

```
import time
import board
import neopixel
import adafruit_lis3dh
import usb_hid
from adafruit_hid.consumer_control import ConsumerControl
from adafruit_hid.consumer_control_code import ConsumerControlCode
```

Keep in mind, not all imported items are libraries. Some of them are almost always built-in CircuitPython modules. How do you know the difference? Time to visit the REPL.

In the [Interacting with the REPL section \(\)](#) on [The REPL page \(\)](#) in this guide, the `help("modules")` command is discussed. This command provides a list of all of the built-in modules available in CircuitPython for your board. So, if you connect to the serial console on your board, and enter the REPL, you can run `help("modules")` to see what modules are available for your board. Then, as you read through the `import` statements, you can, for the purposes of figuring out which libraries to load, ignore the statement that import modules.

The following is the list of modules built into CircuitPython for the Feather RP2040. Your list may look similar or be anything down to a significant subset of this list for smaller boards.

```
>>> help("modules")
__main__      board          micropython    storage
_bleio        builtins       msgpack        struct
adafruit_bus_device  collections   busio          neopixel_write  supervisor
adafruit_pixelbuf  countio       onewireio     synthio
aesio         digitalio     os            sys
alarm         displayio    paralledisplay  terminalio
analogio      errno        pulseio       time
array         fontio       pwmio         touchio
atexit        framebufferio  qrio         traceback
audiobusio    gc           rainbowio     ulab
audiocore     getpass      random        usb_cdc
audiomixer    imagecapture  re           usb_hid
audiomp3      iio          rgbmatrix     usb_midi
audiopwmio    json         rotaryio      vectorio
binascii     keypad       rp2pio        watchdog
bitbangio    math         rtc
bitmaptools  microcontroller  sdcardio
bitops       sharpdisplay
```

Now that you know what you're looking for, it's time to read through the import statements. The first two, `time` and `board`, are on the modules list above, so they're built-in.

The next one, `neopixel`, is not on the module list. That means it's your first library! So, you would head over to the bundle zip you downloaded, and search for neopixel. There is a neopixel.mpy file in the bundle zip. Copy it over to the lib folder on your CIRCUITPY drive. The following one, `adafruit_lis3dh`, is also not on the module list. Follow the same process for `adafruit_lis3dh`, where you'll find `adafruit_lis3dh.mpy`, and copy that over.

The fifth one is `usb_hid`, and it is in the modules list, so it is built in. Often all of the built-in modules come first in the import list, but sometimes they don't! Don't assume that everything after the first library is also a library, and verify each import with the modules list to be sure. Otherwise, you'll search the bundle and come up empty!

The final two imports are not as clear. Remember, when `import` statements are formatted like this, the first thing after the `from` is the library name. In this case, the library name is `adafruit_hid`. A search of the bundle will find an `adafruit_hid` folder. When a library is a folder, you must copy the entire folder and its contents as it is in the bundle to the lib folder on your CIRCUITPY drive. In this case, you would copy the entire `adafruit_hid` folder to your CIRCUITPY/lib folder.

Notice that there are two imports that begin with `adafruit_hid`. Sometimes you will need to import more than one thing from the same library. Regardless of how many times you import the same library, you only need to load the library by copying over the `adafruit_hid` folder once.

That is how you can use your example code to figure out what libraries to load on your CircuitPython-compatible board!

There are cases, however, where libraries require other libraries internally. The internally required library is called a dependency. In the event of library dependencies, the easiest way to figure out what other libraries are required is to connect to the serial console and follow along with the `ImportError` printed there. The following is a very simple example of an `ImportError`, but the concept is the same for any missing library.

## Example: `ImportError` Due to Missing Library

If you choose to load libraries as you need them, or you're starting fresh with an existing example, you may end up with code that tries to use a library you haven't yet loaded. This section will demonstrate what happens when you try to utilise a library that you don't have loaded on your board, and cover the steps required to resolve the issue.

This demonstration will only return an error if you do not have the required library loaded into the lib folder on your CIRCUITPY drive.

Let's use a modified version of the Blink example.

```
import board
import time
import simpleio

led = simpleio.DigitalOut(board.LED)

while True:
    led.value = True
    time.sleep(0.5)
    led.value = False
    time.sleep(0.5)
```

Save this file. Nothing happens to your board. Let's check the serial console to see what's going on.

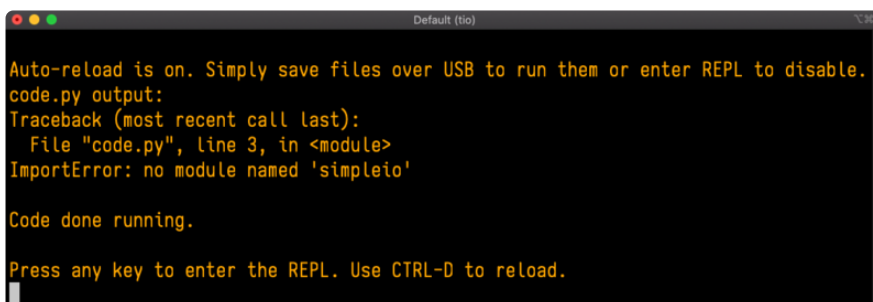

The screenshot shows a terminal window titled "Default (tio)". The output text is as follows:

```
Auto-reload is on. Simply save files over USB to run them or enter REPL to disable.
code.py output:
Traceback (most recent call last):
  File "code.py", line 3, in <module>
    ImportError: no module named 'simpleio'

Code done running.

Press any key to enter the REPL. Use CTRL-D to reload.
```

You have an `ImportError`. It says there is `no module named 'simpleio'`. That's the one you just included in your code!

Click the link above to download the correct bundle. Extract the lib folder from the downloaded bundle file. Scroll down to find `simpleio.mpy`. This is the library file you're looking for! Follow the steps above to load an individual library file.

The LED starts blinking again! Let's check the serial console.

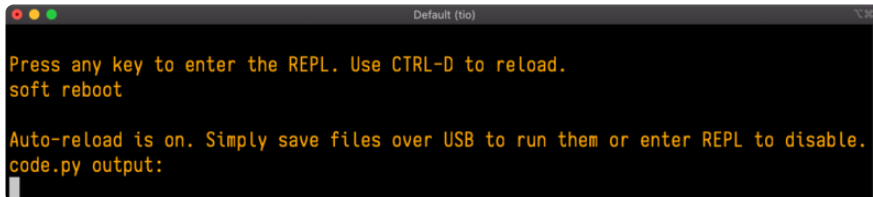
A screenshot of a terminal window titled "Default (tio)". The text inside the terminal is yellow on a black background. It reads: "Press any key to enter the REPL. Use CTRL-D to reload." followed by "soft reboot" on a new line. The next line says "Auto-reload is on. Simply save files over USB to run them or enter REPL to disable." and the final line is "code.py output:". There is a vertical scrollbar on the right side of the terminal window.

```
Default (tio)
Press any key to enter the REPL. Use CTRL-D to reload.
soft reboot
Auto-reload is on. Simply save files over USB to run them or enter REPL to disable.
code.py output:
```

No errors! Excellent. You've successfully resolved an `ImportError`!

If you run into this error in the future, follow along with the steps above and choose the library that matches the one you're missing.

## Library Install on Non-Express Boards

If you have an M0 non-Express board such as Trinket M0, Gemma M0, QT Py M0, or one of the M0 Trinkeys, you'll want to follow the same steps in the example above to install libraries as you need them. Remember, you don't need to wait for an `ImportError` if you know what library you added to your code. Open the library bundle you downloaded, find the library you need, and drag it to the lib folder on your CIRCUITPY drive.

You can still end up running out of space on your M0 non-Express board even if you only load libraries as you need them. There are a number of steps you can use to try to resolve this issue. You'll find suggestions on the [Troubleshooting page](#) ().

## Updating CircuitPython Libraries and Examples

Libraries and examples are updated from time to time, and it's important to update the files you have on your CIRCUITPY drive.

To update a single library or example, follow the same steps above. When you drag the library file to your lib folder, it will ask if you want to replace it. Say yes. That's it!

A new library bundle is released every time there's an update to a library. Updates include things like bug fixes and new features. It's important to check in every so often to see if the libraries you're using have been updated.

## CircUp CLI Tool

There is a command line interface (CLI) utility called [CircUp \(\)](#) that can be used to easily install and update libraries on your device. Follow the directions on the [install page within the CircUp learn guide \(\)](#). Once you've got it installed you run the command `circup update` in a terminal to interactively update all libraries on the connected CircuitPython device. See the [usage page in the CircUp guide \(\)](#) for a full list of functionality

---

## Frequently Asked Questions

These are some of the common questions regarding CircuitPython and CircuitPython microcontrollers.

---

### What are some common acronyms to know?

- CP or CPy = [CircuitPython \(\)](#)
  - CPC = [Circuit Playground Classic \(\)](#) (does not run CircuitPython)
  - CPX = [Circuit Playground Express \(\)](#)
  - CPB = [Circuit Playground Bluefruit \(\)](#)
- 

## Using Older Versions

As CircuitPython development continues and there are new releases, Adafruit will stop supporting older releases. Visit <https://circuitpython.org/downloads> to download the latest version of CircuitPython for your board. You must download the CircuitPython Library Bundle that matches your version of CircuitPython. Please update CircuitPython and then visit <https://circuitpython.org/libraries> to download the latest Library Bundle.

---

### I have to continue using CircuitPython 7.x or earlier. Where can I find compatible libraries?

We are no longer building or supporting the CircuitPython 7.x or earlier library bundles. We highly encourage you to [update CircuitPython to the latest version \(\)](#)

and use [the current version of the libraries \(\)](#). However, if for some reason you cannot update, here are the last available library bundles for older versions:

- [2.x bundle \(\)](#)
  - [3.x bundle \(\)](#)
  - [4.x bundle \(\)](#)
  - [5.x bundle \(\)](#)
  - [6.x bundle \(\)](#)
  - [7.x bundle \(\)](#)
- 

## Python Arithmetic

---

### Does CircuitPython support floating-point numbers?

All CircuitPython boards support floating point arithmetic, even if the microcontroller chip does not support floating point in hardware. Floating point numbers are stored in 30 bits, with an 8-bit exponent and a 22-bit mantissa. Note that this is two bits less than standard 32-bit single-precision floats. You will get about 5-1/2 digits of decimal precision.

(The broadcom port may provide 64-bit floats in some cases.)

---

### Does CircuitPython support long integers, like regular Python?

Python long integers (integers of arbitrary size) are available on most builds, except those on boards with the smallest available firmware size. On these boards, integers are stored in 31 bits.

Boards without long integer support are mostly SAMD21 ("M0") boards without an external flash chip, such as the Adafruit Gemma M0, Trinket M0, QT Py M0, and the Trinky series. There are also a number of third-party boards in this category. There are also a few small STM third-party boards without long integer support.

`time.localtime()`, `time.mktime()`, `time.time()`, and `time.monotonic_ns()` are available only on builds with long integers.

---

## Wireless Connectivity

---

## How do I connect to the Internet with CircuitPython?

If you'd like to include WiFi in your project, your best bet is to use a board that is running natively on ESP32 chipsets - those have WiFi built in!

If your development board has an SPI port and at least 4 additional pins, you can check out [this guide \(\)](#) on using AirLift with CircuitPython - extra wiring is required and some boards like the MacroPad or NeoTrellis do not have enough available pins to add the hardware support.

For further project examples, and guides about using AirLift with specific hardware, check out [the Adafruit Learn System \(\)](#).

---

## How do I do BLE (Bluetooth Low Energy) with CircuitPython?

The nRF52840 and nRF52833 boards have the most complete BLE implementation. Your program can act as both a BLE central and peripheral. As a central, you can scan for advertisements, and connect to an advertising board. As a peripheral, you can advertise, and you can create services available to a central. Pairing and bonding are supported.

ESP32-C3 and ESP32-S3 boards currently provide an [incomplete \(\)](#) BLE implementation. Your program can act as a central, and connect to a peripheral. You can advertise, but you cannot create services. You cannot advertise anonymously. Pairing and bonding are not supported.

The ESP32 could provide a similar implementation, but it is not yet available. Note that the ESP32-S2 does not have Bluetooth capability.

On most other boards with adequate firmware space, [BLE is available for use with AirLift \(\)](#) or other NINA-FW-based co-processors. Some boards have this coprocessor on board, such as the [PyPortal \(\)](#). Currently, this implementation only supports acting as a BLE peripheral. Scanning and connecting as a central are not yet implemented. Bonding and pairing are not supported.

---

## Are there other ways to communicate by radio with CircuitPython?

Check out [Adafruit's RFM boards \(\)](#) for simple radio communication supported by CircuitPython, which can be used over distances of 100m to over a km, depending on the version. The RFM SAMD21 M0 boards can be used, but they were not

designed for CircuitPython, and have limited RAM and flash space; using the RFM breakouts or FeatherWings with more capable boards will be easier.

---

## Asyncio and Interrupts

---

### Is there asyncio support in CircuitPython?

There is support for asyncio starting with CircuitPython 7.1.0, on all boards except the smallest SAMD21 builds. Read about using it in the [Cooperative Multitasking in CircuitPython \(\)](#) Guide.

---

### Does CircuitPython support interrupts?

No. CircuitPython does not currently support interrupts - please use asyncio for multitasking / 'threaded' control of your code

---

## Status RGB LED

---

### My RGB NeoPixel/DotStar LED is blinking funny colors - what does it mean?

The status LED can tell you what's going on with your CircuitPython board. [Read more here for what the colors mean! \(\)](#)

---

## Memory Issues

---

### What is a MemoryError?

Memory allocation errors happen when you're trying to store too much on the board. The CircuitPython microcontroller boards have a limited amount of memory available. You can have about 250 lines of code on the M0 Express boards. If you try to `import` too many libraries, a combination of large libraries, or run a program with too many lines of code, your code will fail to run and you will receive a `MemoryError` in the serial console.

---

### What do I do when I encounter a MemoryError?

Try resetting your board. Each time you reset the board, it reallocates the memory. While this is unlikely to resolve your issue, it's a simple step and is worth trying.

Make sure you are using .mpy versions of libraries. All of the CircuitPython libraries are available in the bundle in a .mpy format which takes up less memory than .py format. Be sure that you're using [the latest library bundle \(\)](#) for your version of CircuitPython.

If that does not resolve your issue, try shortening your code. Shorten comments, remove extraneous or unneeded code, or any other clean up you can do to shorten your code. If you're using a lot of functions, you could try moving those into a separate library, creating a .mpy of that library, and importing it into your code.

You can turn your entire file into a .mpy and `import` that into code.py. This means you will be unable to edit your code live on the board, but it can save you space.

---

## Can the order of my `import` statements affect memory?

It can because the memory gets fragmented differently depending on allocation order and the size of objects. Loading .mpy files uses less memory so its recommended to do that for files you aren't editing.

---

## How can I create my own .mpy files?

You can make your own .mpy versions of files with `mpy-cross`.

You can download `mpy-cross` for your operating system from [here \(\)](#). Builds are available for Windows, macOS, x64 Linux, and Raspberry Pi Linux. Choose the latest `mpy-cross` whose version matches the version of CircuitPython you are using.

To make a .mpy file, run `./mpy-cross path/to/yourfile.py` to create a yourfile.mpy in the same directory as the original file.

---

## How do I check how much memory I have free?

Run the following to see the number of bytes available for use:

```
import gc
gc.mem_free()
```

---

## Unsupported Hardware

---

## Is ESP8266 or ESP32 supported in CircuitPython? Why not?

We dropped ESP8266 support as of 4.x - For more information please read about it [here](#) ()!

As of CircuitPython 8.x we have started to support ESP32 and ESP32-C3 and have added a WiFi workflow for wireless coding! ()

We also support ESP32-S2 & ESP32-S3, which have native USB.

---

## Does Feather M0 support WINC1500?

No, WINC1500 will not fit into the M0 flash space.

---

## Can AVR's such as ATmega328 or ATmega2560 run CircuitPython?

No.

---

## CircuitPython Expectations

As we continue to develop CircuitPython and create new releases, we will stop supporting older releases. Visit <https://circuitpython.org/downloads> to download the latest version of CircuitPython for your board. You must download the CircuitPython Library Bundle that matches your version of CircuitPython. Please update CircuitPython and then visit <https://circuitpython.org/libraries> to download the latest Library Bundle.

## Always Run the Latest Version of CircuitPython and Libraries

As we continue to develop CircuitPython and create new releases, we will stop supporting older releases. You need to [update to the latest CircuitPython](#) ().

You need to download the CircuitPython Library Bundle that matches your version of CircuitPython. Please update CircuitPython and then [download the latest bundle](#) ().

As we release new versions of CircuitPython, we will stop providing the previous bundles as automatically created downloads on the Adafruit CircuitPython Library

Bundle repo. If you must continue to use an earlier version, you can still download the appropriate version of `mpy-cross` from the particular release of CircuitPython on the CircuitPython repo and create your own compatible .mpy library files. However, it is best to update to the latest for both CircuitPython and the library bundle.

## I have to continue using CircuitPython 3.x or 2.x, where can I find compatible libraries?

We are no longer building or supporting the CircuitPython 2.x and 3.x library bundles. We highly encourage you to [update CircuitPython to the latest version \(\)](#) and use [the current version of the libraries \(\)](#). However, if for some reason you cannot update, you can find [the last available 2.x build here \(\)](#) and [the last available 3.x build here \(\)](#).

## Switching Between CircuitPython and Arduino

Many of the CircuitPython boards also run Arduino. But how do you switch between the two? Switching between CircuitPython and Arduino is easy.

If you're currently running Arduino and would like to start using CircuitPython, follow the steps found in [Welcome to CircuitPython: Installing CircuitPython \(\)](#).

If you're currently running CircuitPython and would like to start using Arduino, plug in your board, and then load your Arduino sketch. If there are any issues, you can double tap the reset button to get into the bootloader and then try loading your sketch. Always backup any files you're using with CircuitPython that you want to save as they could be deleted.

That's it! It's super simple to switch between the two.

## The Difference Between Express And Non-Express Boards

We often reference "Express" and "Non-Express" boards when discussing CircuitPython. What does this mean?

Express refers to the inclusion of an extra 2MB flash chip on the board that provides you with extra space for CircuitPython and your code. This means that we're able to include more functionality in CircuitPython and you're able to do more with your code on an Express board than you would on a non-Express board.

Express boards include Circuit Playground Express, ItsyBitsy M0 Express, Feather M0 Express, Metro M0 Express and Metro M4 Express.

Non-Express boards include Trinket M0, Gemma M0, QT Py, Feather M0 Basic, and other non-Express Feather M0 variants.

## Non-Express Boards: Gemma, Trinket, and QT Py

CircuitPython runs nicely on the Gemma M0, Trinket M0, or QT Py M0 but there are some constraints

### Small Disk Space

Since we use the internal flash for disk, and that's shared with runtime code, it's limited! Only about 50KB of space.

### No Audio or NVM

Part of giving up that FLASH for disk means we couldn't fit everything in. There is, at this time, no support for hardware audio playback or NVM 'eeprom'. Modules `audioio` and `bitbangio` are not included. For that support, check out the Circuit Playground Express or other Express boards.

However, I2C, UART, capacitive touch, NeoPixel, DotStar, PWM, analog in and out, digital IO, logging storage, and HID do work! Check the CircuitPython Essentials for examples of all of these.

## Differences Between CircuitPython and MicroPython

For the differences between CircuitPython and MicroPython, check out the [CircuitPython on documentation \(\)](#).

# Differences Between CircuitPython and Python

Python (also known as CPython) is the language that MicroPython and CircuitPython are based on. There are many similarities, but there are also many differences. This is a list of a few of the differences.

## Python Libraries

Python is advertised as having "batteries included", meaning that many standard libraries are included. Unfortunately, for space reasons, many Python libraries are not available. So for instance while we wish you could `import numpy`, `numpy` isn't available (look for the `ulab` library for similar functions to `numpy` which works on many microcontroller boards). So you may have to port some code over yourself!

## Integers in CircuitPython

On the non-Express boards, integers can only be up to 31 bits long. Integers of unlimited size are not supported. The largest positive integer that can be represented is  $2^{30}-1$ , 1073741823, and the most negative integer possible is  $-2^{30}$ , -1073741824.

As of CircuitPython 3.0, Express boards have arbitrarily long integers as in Python.

## Floating Point Numbers and Digits of Precision for Floats in CircuitPython

Floating point numbers are single precision in CircuitPython (not double precision as in Python). The largest floating point magnitude that can be represented is about  $\pm 3.4e38$ . The smallest magnitude that can be represented with full accuracy is about  $\pm 1.7e-38$ , though numbers as small as  $\pm 5.6e-45$  can be represented with reduced accuracy.

CircuitPython's floats have 8 bits of exponent and 22 bits of mantissa (not 24 like regular single precision floating point), which is about five or six decimal digits of precision.

## Differences between MicroPython and Python

For a more detailed list of the differences between CircuitPython and Python, you can look at the MicroPython documentation. [We keep up with MicroPython stable releases, so check out the core 'differences' they document here. \(\)](#)

---

## Troubleshooting

From time to time, you will run into issues when working with CircuitPython. Here are a few things you may encounter and how to resolve them.

As CircuitPython development continues and there are new releases, Adafruit will stop supporting older releases. Visit <https://circuitpython.org/downloads> to download the latest version of CircuitPython for your board. You must download the CircuitPython Library Bundle that matches your version of CircuitPython. Please update CircuitPython and then visit <https://circuitpython.org/libraries> to download the latest Library Bundle.

## Always Run the Latest Version of CircuitPython and Libraries

As CircuitPython development continues and there are new releases, Adafruit will stop supporting older releases. You need to [update to the latest CircuitPython. \(\)](#).

You need to download the CircuitPython Library Bundle that matches your version of CircuitPython. Please update CircuitPython and then [download the latest bundle \(\)](#).

As new versions of CircuitPython are released, Adafruit will stop providing the previous bundles as automatically created downloads on the Adafruit CircuitPython Library Bundle repo. If you must continue to use an earlier version, you can still download the appropriate version of `mpy-cross` from the particular release of CircuitPython on the CircuitPython repo and create your own compatible `.mpy` library files. However, it is best to update to the latest for both CircuitPython and the library bundle.

## I have to continue using CircuitPython 5.x or earlier. Where can I find compatible libraries?

Adafruit is no longer building or supporting the CircuitPython 5.x or earlier library bundles. You are highly encouraged to [update CircuitPython to the latest version \(\)](#) and use [the current version of the libraries \(\)](#). However, if for some reason you cannot update, links to the previous bundles are available in the [FAQ \(\)](#).

## Bootloader (boardnameBOOT) Drive Not Present

You may have a different board.

Only Adafruit Express boards and the SAMD21 non-Express boards ship with the [UF2 bootloader \(\)](#) installed. The Feather M0 Basic, Feather M0 Adalogger, and similar boards use a regular Arduino-compatible bootloader, which does not show a boardnameBOOT drive.

### MakeCode

If you are running a [MakeCode \(\)](#) program on Circuit Playground Express, press the reset button just once to get the CPLAYBOOT drive to show up. Pressing it twice will not work.

### MacOS

DriveDx and its accompanying SAT SMART Driver can interfere with seeing the BOOT drive. [See this forum post \(\)](#) for how to fix the problem.

### Windows 10

Did you install the Adafruit Windows Drivers package by mistake, or did you upgrade to Windows 10 with the driver package installed? You don't need to install this package on Windows 10 for most Adafruit boards. The old version (v1.5) can interfere with recognizing your device. Go to Settings -> Apps and uninstall all the "Adafruit" driver programs.

## Windows 7 or 8.1

To use a CircuitPython-compatible board with Windows 7 or 8.1, you must install a driver. Installation instructions are available [here](#) ().

It is [recommended](#) () that you upgrade to Windows 10 if possible; an upgrade is probably still free for you. Check [here](#) ().

The Windows Drivers installer was last updated in November 2020 (v2.5.0.0) . Windows 7 drivers for CircuitPython boards released since then, including RP2040 boards, are not yet available. The boards work fine on Windows 10. A new release of the drivers is in process.

You should now be done! Test by unplugging and replugging the board. You should see the CIRCUITPY drive, and when you double-click the reset button (single click on Circuit Playground Express running MakeCode), you should see the appropriate boardnameBOOT drive.

Let us know in the [Adafruit support forums](#) () or on the [Adafruit Discord](#) () if this does not work for you!

## Windows Explorer Locks Up When Accessing boardnameBOOT Drive

On Windows, several third-party programs that can cause issues. The symptom is that you try to access the boardnameBOOT drive, and Windows or Windows Explorer seems to lock up. These programs are known to cause trouble:

- AIDA64: to fix, stop the program. This problem has been reported to AIDA64. They acquired hardware to test, and released a beta version that fixes the problem. This may have been incorporated into the latest release. Please let us know in the forums if you test this.
- Hard Disk Sentinel
- Kaspersky anti-virus: To fix, you may need to disable Kaspersky completely. Disabling some aspects of Kaspersky does not always solve the problem. This problem has been reported to Kaspersky.
- ESET NOD32 anti-virus: There have been problems with at least version 9.0.386.0, solved by uninstallation.

# Copying UF2 to boardnameBOOT Drive Hangs at 0% Copied

On Windows, a Western Digital (WD) utility that comes with their external USB drives can interfere with copying UF2 files to the boardnameBOOT drive. Uninstall that utility to fix the problem.

# CIRCUITPY Drive Does Not Appear or Disappears Quickly

Kaspersky anti-virus can block the appearance of the CIRCUITPY drive. There has not yet been settings change discovered that prevents this. Complete uninstallation of Kaspersky fixes the problem.

Norton anti-virus can interfere with CIRCUITPY. A user has reported this problem on Windows 7. The user turned off both Smart Firewall and Auto Protect, and CIRCUITPY then appeared.

Sophos Endpoint security software [can cause CIRCUITPY to disappear \(\)](#) and the BOOT drive to reappear. It is not clear what causes this behavior.

# Device Errors or Problems on Windows

Windows can become confused about USB device installations. This is particularly true of Windows 7 and 8.1. It is [recommended \(\)](#) that you upgrade to Windows 10 if possible; an upgrade is probably still free for you: see this [link \(\)](#).

If not, try cleaning up your USB devices. Use [Uwe Sieber's Device Cleanup Tool \(\)](#) (on that page, scroll down to "Device Cleanup Tool"). Download and unzip the tool. Unplug all the boards and other USB devices you want to clean up. Run the tool as Administrator. You will see a listing like this, probably with many more devices. It is listing all the USB devices that are not currently attached.

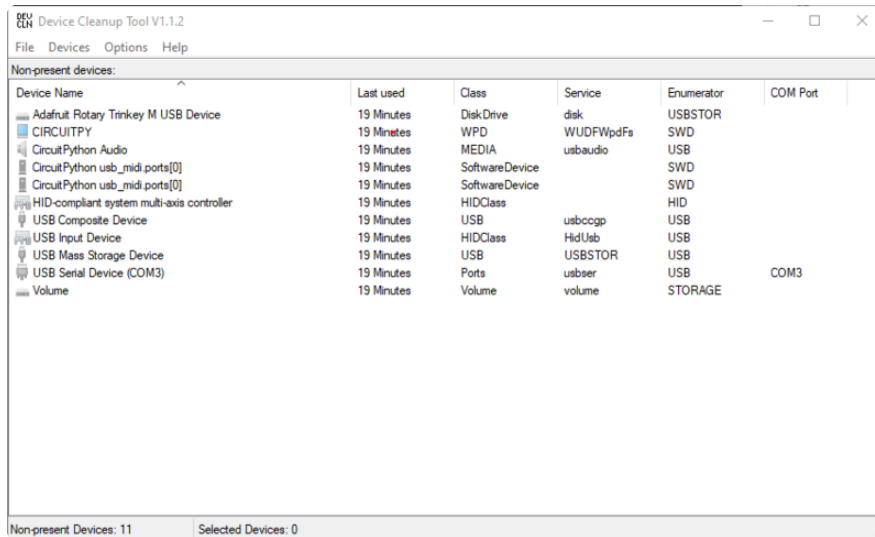

Select all the devices you want to remove, and then press Delete. It is usually safe just to select everything. Any device that is removed will get a fresh install when you plug it in. Using the Device Cleanup Tool also discards all the COM port assignments for the unplugged boards. If you have used many Arduino and CircuitPython boards, you have probably seen higher and higher COM port numbers used, seemingly without end. This will fix that problem.

## Serial Console in Mu Not Displaying Anything

There are times when the serial console will accurately not display anything, such as, when no code is currently running, or when code with no serial output is already running before you open the console. However, if you find yourself in a situation where you feel it should be displaying something like an error, consider the following.

Depending on the size of your screen or Mu window, when you open the serial console, the serial console panel may be very small. This can be a problem. A basic CircuitPython error takes 10 lines to display!

```
Auto-reload is on. Simply save files over USB to run them or enter REPL to disable.
code.py output:
Traceback (most recent call last):
  File "code.py", line 7
SyntaxError: invalid syntax

Press any key to enter the REPL. Use CTRL-D to reload.
```

More complex errors take even more lines!

Therefore, if your serial console panel is five lines tall or less, you may only see blank lines or blank lines followed by **Press any key to enter the REPL. Use CTRL-D to reload.** . If this is the case, you need to either mouse over the top of the panel to utilise the option to resize the serial panel, or use the scrollbar on the right side to scroll up and find your message.

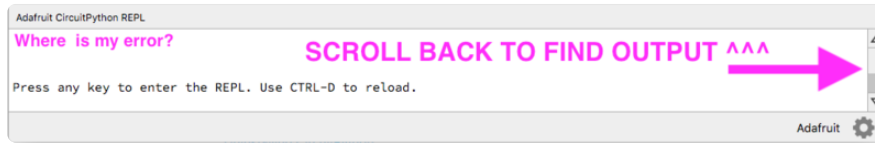

This applies to any kind of serial output whether it be error messages or print statements. So before you start trying to debug your problem on the hardware side, be sure to check that you haven't simply missed the serial messages due to serial output panel height.

## code.py Restarts Constantly

CircuitPython will restart code.py if you or your computer writes to something on the CIRCUITPY drive. This feature is called auto-reload, and lets you test a change to your program immediately.

Some utility programs, such as backup, anti-virus, or disk-checking apps, will write to the CIRCUITPY as part of their operation. Sometimes they do this very frequently, causing constant restarts.

Acronis True Image and related Acronis programs on Windows are known to cause this problem. It is possible to prevent this by [disabling the "\(\)Acronis Managed Machine Service Mini" \(\)](#).

If you cannot stop whatever is causing the writes, you can disable auto-reload by putting this code in boot.py or code.py:

```
import supervisor
supervisor.runtime.autoreload = False
```

## CircuitPython RGB Status Light

Nearly all CircuitPython-capable boards have a single NeoPixel or DotStar RGB LED on the board that indicates the status of CircuitPython. A few boards designed before CircuitPython existed, such as the Feather M0 Basic, do not.

Circuit Playground Express and Circuit Playground Bluefruit have multiple RGB LEDs, but do NOT have a status LED. The LEDs are all green when in the bootloader. In versions before 7.0.0, they do NOT indicate any status while running CircuitPython.

## CircuitPython 7.0.0 and Later

The status LED blinks were changed in CircuitPython 7.0.0 in order to save battery power and simplify the blinks. These blink patterns will occur on single color LEDs when the board does not have any RGB LEDs. Speed and blink count also vary for this reason.

On start up, the LED will blink YELLOW multiple times for 1 second. Pressing the RESET button (or on Espressif, the BOOT button) during this time will restart the board and then enter safe mode. On Bluetooth capable boards, after the yellow blinks, there will be a set of faster blue blinks. Pressing reset during the BLUE blinks will clear Bluetooth information and start the device in discoverable mode, so it can be used with a BLE code editor.

Once started, CircuitPython will blink a pattern every 5 seconds when no user code is running to indicate why the code stopped:

- 1 GREEN blink: Code finished without error.
- 2 RED blinks: Code ended due to an exception. Check the serial console for details.
- 3 YELLOW blinks: CircuitPython is in safe mode. No user code was run. Check the serial console for safe mode reason.

When in the REPL, CircuitPython will set the status LED to WHITE. You can change the LED color from the REPL. The status indicator will not persist on non-NeoPixel or DotStar LEDs.

## The CircuitPython Boot Sequence

Version 7.0 and later

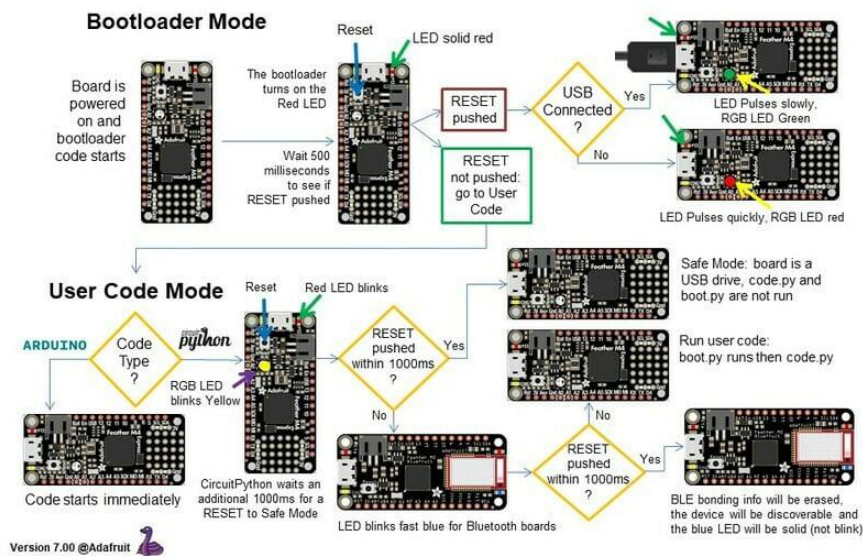

## CircuitPython 6.3.0 and earlier

Here's what the colors and blinking mean:

- steady GREEN: code.py (or code.txt, main.py, or main.txt) is running
- pulsing GREEN: code.py (etc.) has finished or does not exist
- steady YELLOW at start up: (4.0.0-alpha.5 and newer) CircuitPython is waiting for a reset to indicate that it should start in safe mode
- pulsing YELLOW: Circuit Python is in safe mode: it crashed and restarted
- steady WHITE: REPL is running
- steady BLUE: boot.py is running

Colors with multiple flashes following indicate a Python exception and then indicate the line number of the error. The color of the first flash indicates the type of error:

- GREEN: IndentationError
- CYAN: SyntaxError
- WHITE: NameError
- ORANGE: OSError
- PURPLE: ValueError
- YELLOW: other error

These are followed by flashes indicating the line number, including place value. WHITE flashes are thousands' place, BLUE are hundreds' place, YELLOW are tens' place,

and CYAN are one's place. So for example, an error on line 32 would flash YELLOW three times and then CYAN two times. Zeroes are indicated by an extra-long dark gap.

### The CircuitPython Boot Sequence

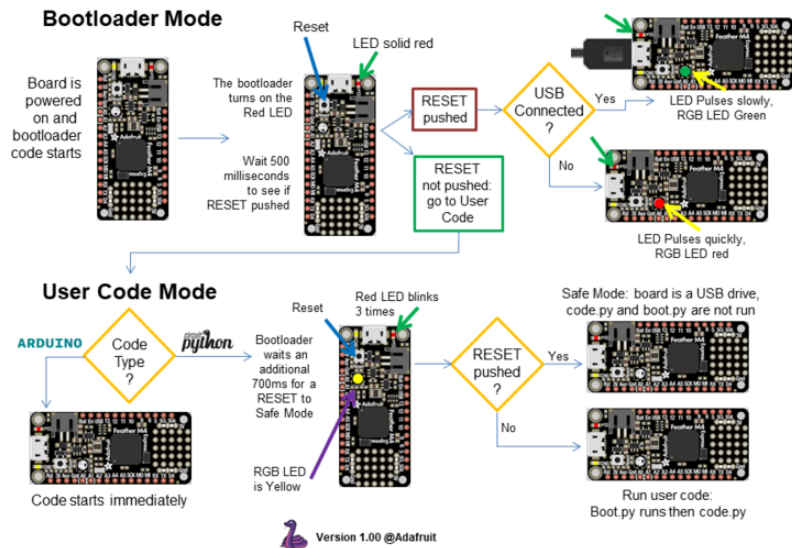

## Serial console showing **ValueError: Incompatible .mpy file**

This error occurs when importing a module that is stored as a .mpy binary file that was generated by a different version of CircuitPython than the one its being loaded into. In particular, the mpy binary format changed between CircuitPython versions 6.x and 7.x, 2.x and 3.x, and 1.x and 2.x.

So, for instance, if you upgraded to CircuitPython 7.x from 6.x you'll need to download a newer version of the library that triggered the error on `import`. All libraries are available in the [Adafruit bundle \(\)](#).

## CIRCUITPY Drive Issues

You may find that you can no longer save files to your CIRCUITPY drive. You may find that your CIRCUITPY stops showing up in your file explorer, or shows up as NO\_NAME. These are indicators that your filesystem has issues. When the CIRCUITPY disk is not safely ejected before being reset by the button or being disconnected from USB, it may corrupt the flash drive. It can happen on Windows, Mac or Linux, though it is more common on Windows.

Be aware, if you have used Arduino to program your board, CircuitPython is no longer able to provide the USB services. You will need to reload CircuitPython to resolve this situation.

The easiest first step is to reload CircuitPython. Double-tap reset on the board so you get a boardnameBOOT drive rather than a CIRCUITPY drive, and copy the latest version of CircuitPython (.uf2) back to the board. This may restore CIRCUITPY functionality.

If reloading CircuitPython does not resolve your issue, the next step is to try putting the board into safe mode.

## Safe Mode

Whether you've run into a situation where you can no longer edit your code.py on your CIRCUITPY drive, your board has gotten into a state where CIRCUITPY is read-only, or you have turned off the CIRCUITPY drive altogether, safe mode can help.

Safe mode in CircuitPython does not run any user code on startup, and disables auto-reload. This means a few things. First, safe mode bypasses any code in boot.py (where you can set CIRCUITPY read-only or turn it off completely). Second, it does not run the code in code.py. And finally, it does not automatically soft-reload when data is written to the CIRCUITPY drive.

Therefore, whatever you may have done to put your board in a non-interactive state, safe mode gives you the opportunity to correct it without losing all of the data on the CIRCUITPY drive.

## Entering Safe Mode in CircuitPython 7.x and Later

To enter safe mode when using CircuitPython 7.x, plug in your board or hit reset (highlighted in red above). Immediately after the board starts up or resets, it waits 1000ms. On some boards, the onboard status LED will blink yellow during that time. If you press reset during that 1000ms, the board will start up in safe mode. It can be difficult to react to the yellow LED, so you may want to think of it simply as a "slow" double click of the reset button. (Remember, a fast double click of reset enters the bootloader.)

## Entering Safe Mode in CircuitPython 6.x

To enter safe mode when using CircuitPython 6.x, plug in your board or hit reset (highlighted in red above). Immediately after the board starts up or resets, it waits 700ms. On some boards, the onboard status LED (highlighted in green above) will turn solid yellow during this time. If you press reset during that 700ms, the board will start up in safe mode. It can be difficult to react to the yellow LED, so you may want to think of it simply as a slow double click of the reset button. (Remember, a fast double click of reset enters the bootloader.)

## In Safe Mode

Once you've entered safe mode successfully in CircuitPython 6.x, the LED will pulse yellow.

If you successfully enter safe mode on CircuitPython 7.x, the LED will intermittently blink yellow three times.

If you connect to the serial console, you'll find the following message.

```
Auto-reload is off.  
Running in safe mode! Not running saved code.  
  
CircuitPython is in safe mode because you pressed the reset button during boot.  
Press again to exit safe mode.  
  
Press any key to enter the REPL. Use CTRL-D to reload.
```

You can now edit the contents of the CIRCUITPY drive. Remember, your code will not run until you press the reset button, or unplug and plug in your board, to get out of safe mode.

At this point, you'll want to remove any user code in code.py and, if present, the boot.py file from CIRCUITPY. Once removed, tap the reset button, or unplug and plug in your board, to restart CircuitPython. This will restart the board and may resolve your drive issues. If resolved, you can begin coding again as usual.

If safe mode does not resolve your issue, the board must be completely erased and CircuitPython must be reloaded onto the board.

**You WILL lose everything on the board when you complete the following steps. If possible, make a copy of your code before continuing.**

## To erase CIRCUITPY: `storage.erase_filesystem()`

CircuitPython includes a built-in function to erase and reformat the filesystem. If you have a version of CircuitPython older than 2.3.0 on your board, you can [update to the newest version \(\)](#) to do this.

1. [Connect to the CircuitPython REPL \(\)](#) using Mu or a terminal program.
2. Type the following into the REPL:

```
>>> import storage
>>> storage.erase_filesystem()
```

CIRCUITPY will be erased and reformatted, and your board will restart. That's it!

## Erase CIRCUITPY Without Access to the REPL

If you can't access the REPL, or you're running a version of CircuitPython previous to 2.3.0 and you don't want to upgrade, there are options available for some specific boards.

The options listed below are considered to be the "old way" of erasing your board. The method shown above using the REPL is highly recommended as the best method for erasing your board.

If at all possible, it is recommended to use the REPL to erase your CIRCUITPY drive. The REPL method is explained above.

## For the specific boards listed below:

If the board you are trying to erase is listed below, follow the steps to use the file to erase your board.

1. Download the correct erase file:

Circuit Playground Express

Feather M0 Express

Feather M4 Express



2. Double-click the reset button on the board to bring up the boardnameBOOT drive.
3. Drag the erase .uf2 file to the boardnameBOOT drive.
4. The status LED will turn yellow or blue, indicating the erase has started.
5. After approximately 15 seconds, the status LED will light up green. On the NeoTrellis M4 this is the first NeoPixel on the grid
6. Double-click the reset button on the board to bring up the boardnameBOOT drive.
7. [Drag the appropriate latest release of CircuitPython \(\)](#) .uf2 file to the boardnameBOOT drive.

It should reboot automatically and you should see CIRCUITPY in your file explorer again.

If the LED flashes red during step 5, it means the erase has failed. Repeat the steps starting with 2.

[If you haven't already downloaded the latest release of CircuitPython for your board, check out the installation page \(\)](#). You'll also need to load your code and reinstall your libraries!

## For SAMD21 non-Express boards that have a UF2 bootloader:

Any SAMD21-based microcontroller that does not have external flash available is considered a SAMD21 non-Express board. Non-Express boards that have a UF2 bootloader include Trinket M0, GEMMA M0, QT Py M0, and the SAMD21-based Trinky boards.

If you are trying to erase a SAMD21 non-Express board, follow these steps to erase your board.

1. Download the erase file:

SAMD21 non-Express Boards

2. Double-click the reset button on the board to bring up the boardnameBOOT drive.
3. Drag the erase .uf2 file to the boardnameBOOT drive.
4. The boot LED will start flashing again, and the boardnameBOOT drive will reappear.
5. [Drag the appropriate latest release CircuitPython \(\)](#) .uf2 file to the boardnameBOOT drive.

It should reboot automatically and you should see CIRCUITPY in your file explorer again.

[If you haven't already downloaded the latest release of CircuitPython for your board, check out the installation page \(\)](#) You'll also need to load your code and reinstall your libraries!

For SAMD21 non-Express boards that do not have a UF2 bootloader:

Any SAMD21-based microcontroller that does not have external flash available is considered a SAMD21 non-Express board. Non-Express boards that do not have a UF2 bootloader include the Feather M0 Basic Proto, Feather Adalogger, or the Arduino Zero.

If you are trying to erase a non-Express board that does not have a UF2 bootloader, [follow these directions to reload CircuitPython using `bossac` \(\)](#), which will erase and re-create CIRCUITPY.

## Running Out of File Space on SAMD21 Non-Express Boards

Any SAMD21-based microcontroller that does not have external flash available is considered a SAMD21 non-Express board. This includes boards like the Trinket M0, GEMMA M0, QT Py M0, and the SAMD21-based Trinky boards.

The file system on the board is very tiny. (Smaller than an ancient floppy disk.) So, it's likely you'll run out of space but don't panic! There are a number of ways to free up space.

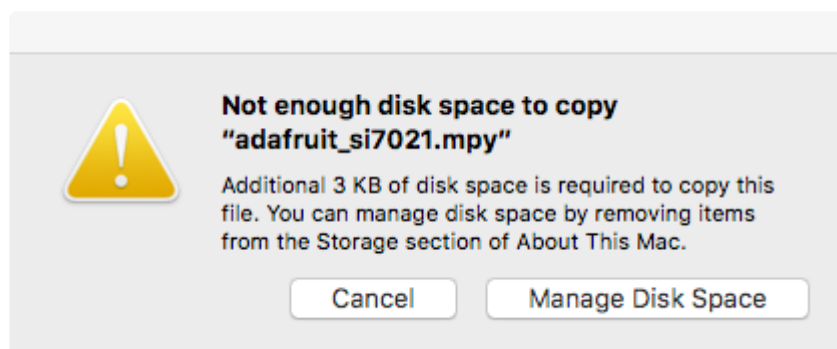

### Delete something!

The simplest way of freeing up space is to delete files from the drive. Perhaps there are libraries in the lib folder that you aren't using anymore or test code that isn't in use. Don't delete the lib folder completely, though, just remove what you don't need.

The board ships with the Windows 7 serial driver too! Feel free to delete that if you don't need it or have already installed it. It's ~12KiB or so.

## Use tabs

One unique feature of Python is that the indentation of code matters. Usually the recommendation is to indent code with four spaces for every indent. In general, that is recommended too. However, one trick to storing more human-readable code is to use a single tab character for indentation. This approach uses 1/4 of the space for indentation and can be significant when you're counting bytes.

## On MacOS?

MacOS loves to generate hidden files. Luckily you can disable some of the extra hidden files that macOS adds by running a few commands to disable search indexing and create zero byte placeholders. Follow the steps below to maximize the amount of space available on macOS.

## Prevent & Remove MacOS Hidden Files

First find the volume name for your board. With the board plugged in run this command in a terminal to list all the volumes:

```
ls -l /Volumes
```

Look for a volume with a name like CIRCUITPY (the default for CircuitPython). The full path to the volume is the /Volumes/CIRCUITPY path.

Now follow the [steps from this question \(\)](#) to run these terminal commands that stop hidden files from being created on the board:

```
mdutil -i off /Volumes/CIRCUITPY
cd /Volumes/CIRCUITPY
rm -rf .{,._}{fseventsd,Spotlight-V*,Trashes}
mkdir .fseventsd
touch .fseventsd/no_log .metadata_never_index .Trashes
cd -
```

Replace /Volumes/CIRCUITPY in the commands above with the full path to your board's volume if it's different. At this point all the hidden files should be cleared from the board and some hidden files will be prevented from being created.

Alternatively, with CircuitPython 4.x and above, the special files and folders mentioned above will be created automatically if you erase and reformat the filesystem. **WARNING: Save your files first! Do this in the REPL:**

```
>>> import storage
>>> storage.erase_filesystem()
```

However there are still some cases where hidden files will be created by MacOS. In particular if you copy a file that was downloaded from the internet it will have special metadata that MacOS stores as a hidden file. Luckily you can run a copy command from the terminal to copy files without this hidden metadata file. See the steps below.

## Copy Files on MacOS Without Creating Hidden Files

Once you've disabled and removed hidden files with the above commands on macOS you need to be careful to copy files to the board with a special command that prevents future hidden files from being created. Unfortunately you cannot use drag and drop copy in Finder because it will still create these hidden extended attribute files in some cases (for files downloaded from the internet, like Adafruit's modules).

To copy a file or folder use the `-X` option for the `cp` command in a terminal. For example to copy a `file_name.mpy` file to the board use a command like:

```
cp -X file_name.mpy /Volumes/CIRCUITPY
```

(Replace `file_name.mpy` with the name of the file you want to copy.)

Or to copy a folder and all of the files and folders contained within, use a command like:

```
cp -rX folder_to_copy /Volumes/CIRCUITPY
```

If you are copying to the `lib` folder, or another folder, make sure it exists before copying.

```
# if lib does not exist, you'll create a file named lib !
cp -X file_name.mpy /Volumes/CIRCUITPY/lib
# This is safer, and will complain if a lib folder does not exist.
cp -X file_name.mpy /Volumes/CIRCUITPY/lib/
```

## Other MacOS Space-Saving Tips

If you'd like to see the amount of space used on the drive and manually delete hidden files here's how to do so. First, move into the `Volumes/` directory with `cd /Volumes/`, and then list the amount of space used on the `CIRCUITPY` drive with the `df` command.

```
Default (-bash)
Last login: Thu Oct 28 17:19:15 on ttys008

7039 kattni@robocrepe:~ $ cd /Volumes/

7040 kattni@robocrepe:Volumes $ df -h CIRCUITPY/
Filesystem      Size  Used Avail Capacity  iused ifree %iused  Mounted on
/dev/disk2s1    47Ki  46Ki  1.0Ki   98%     512     0 100%    /Volumes/CIRCUITPY

7041 kattni@robocrepe:Volumes $
```

That's not very much space left! The next step is to show a list of the files currently on the CIRCUITPY drive, including the hidden files, using the `ls` command. You cannot use Finder to do this, you must do it via command line!

```
7041 kattni@robocrepe:Volumes $ ls -a CIRCUITPY/
.          ._trinket_code.py  code.py
..         .fseventsd         lib
.Trashes   .idea              original_code.py
._code.py  .metadata_never_index trinket_code.py
._original_code.py boot_out.txt

7042 kattni@robocrepe:Volumes $
```

There are a few of the hidden files that MacOS loves to generate, all of which begin with a `._` before the file name. Remove the `._` files using the `rm` command. You can remove them all once by running `rm CIRCUITPY/._*`. The `*` acts as a wildcard to apply the command to everything that begins with `._` at the same time.

```
7042 kattni@robocrepe:Volumes $ rm CIRCUITPY/._*

7043 kattni@robocrepe:Volumes $
```

Finally, you can run `df` again to see the current space used.

```
7043 kattni@robocrepe:Volumes $ df -h CIRCUITPY/
Filesystem      Size  Used Avail Capacity  iused ifree %iused  Mounted on
/dev/disk2s1    47Ki  34Ki  13Ki   73%     512     0 100%    /Volumes/CIRCUITPY

7044 kattni@robocrepe:Volumes $
```

Nice! You have 12Ki more than before! This space can now be used for libraries and code!

## Device Locked Up or Boot Looping

In rare cases, it may happen that something in your `code.py` or `boot.py` files causes the device to get locked up, or even go into a boot loop. A boot loop occurs when the board reboots repeatedly and never fully loads. These are not caused by your everyday Python exceptions, typically it's the result of a deeper problem within CircuitPython. In this situation, it can be difficult to recover your device if CIRCUITPY is not allowing you to modify the `code.py` or `boot.py` files. Safe mode is one recovery option. When the device boots up in safe mode it will not run the `code.py` or `boot.py`

scripts, but will still connect the CIRCUITPY drive so that you can remove or modify those files as needed.

The method used to manually enter safe mode can be different for different devices. It is also very similar to the method used for getting into bootloader mode, which is a different thing. So it can take a few tries to get the timing right. If you end up in bootloader mode, no problem, you can try again without needing to do anything else.

For most devices:

Press the reset button, and then when the RGB status LED blinks yellow, press the reset button again. Since your reaction time may not be that fast, try a "slow" double click, to catch the yellow LED on the second click.

For ESP32-S2 based devices:

Press and release the reset button, then press and release the boot button about 3/4 of a second later.

Refer to the diagrams above for boot sequence details.

---

## "Uninstalling" CircuitPython

A lot of our boards can be used with multiple programming languages. For example, the Circuit Playground Express can be used with MakeCode, Code.org CS Discoveries, CircuitPython and Arduino.

Maybe you tried CircuitPython and want to go back to MakeCode or Arduino? Not a problem. You can always remove or reinstall CircuitPython whenever you want! Heck, you can change your mind every day!

There is nothing to uninstall. CircuitPython is "just another program" that is loaded onto your board. You simply load another program (Arduino or MakeCode) and it will overwrite CircuitPython.

## Backup Your Code

Before replacing CircuitPython, don't forget to make a backup of the code you have on the CIRCUITPY drive. That means your code.py any other files, the lib folder etc. You may lose these files when you remove CircuitPython, so backups are key! Just drag the files to a folder on your laptop or desktop computer like you would with any USB drive.

# Moving Circuit Playground Express to MakeCode

On the Circuit Playground Express (this currently does NOT apply to Circuit Playground Bluefruit), if you want to go back to using MakeCode, it's really easy. Visit [makecode.adafruit.com](https://makecode.adafruit.com/) () and find the program you want to upload. Click Download to download the .uf2 file that is generated by MakeCode.

Now double-click your CircuitPython board until you see the onboard LED(s) turn green and the ...BOOT directory shows up.

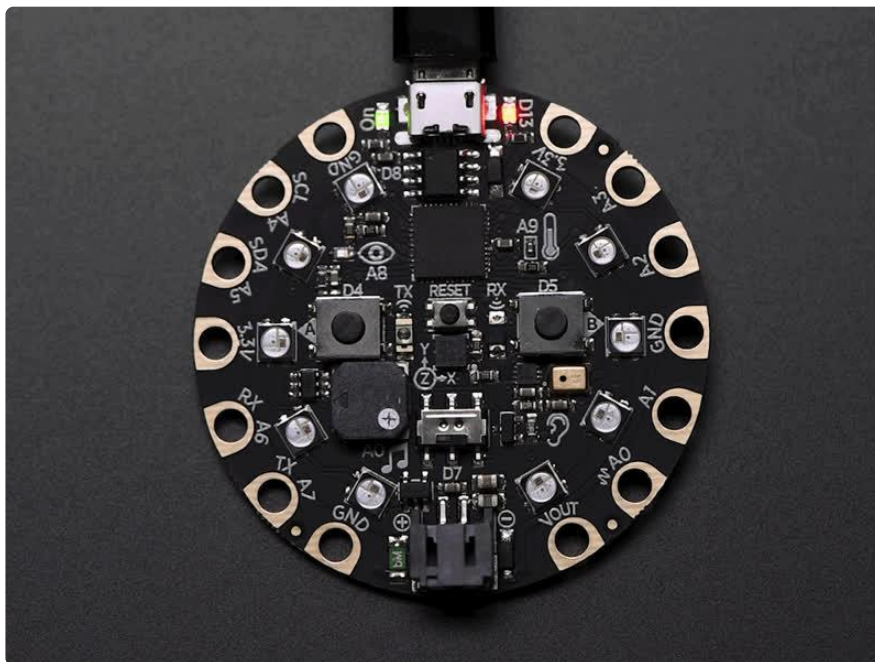

Then find the downloaded MakeCode .uf2 file and drag it to the CPLAYBOOT drive.

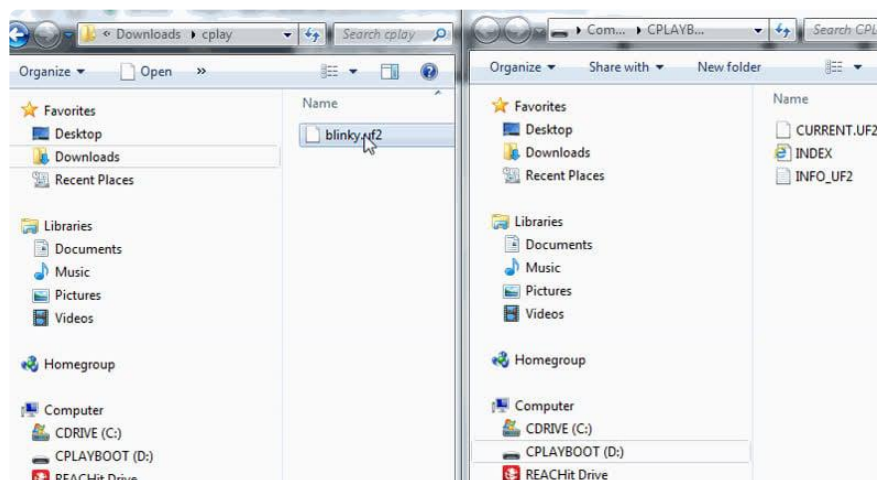

Your MakeCode is now running and CircuitPython has been removed. Going forward you only have to single click the reset button to get to CPLAYBOOT. This is an idiosyncrasy of MakeCode.

## Moving to Arduino

If you want to use Arduino instead, you just use the Arduino IDE to load an Arduino program. Here's an example of uploading a simple "Blink" Arduino program, but you don't have to use this particular program.

Start by plugging in your board, and double-clicking reset until you get the green onboard LED(s).

Within Arduino IDE, select the matching board, say Circuit Playground Express.

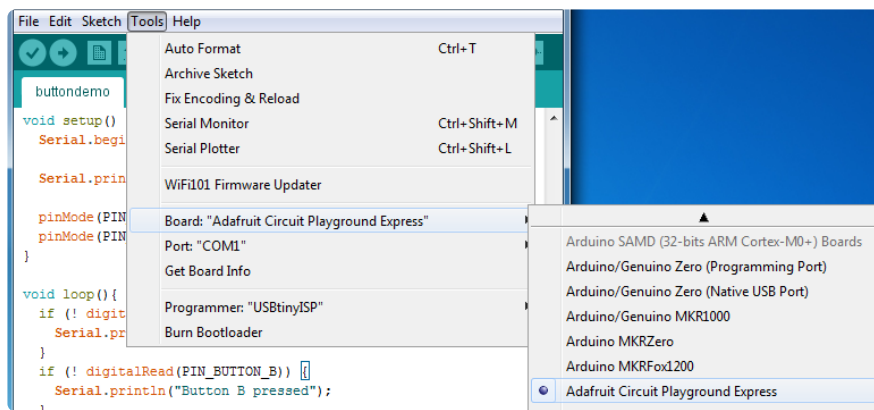

Select the correct matching Port:

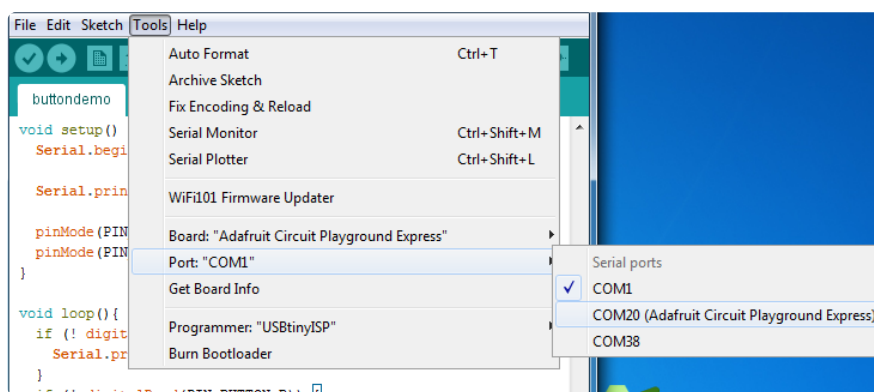

Create a new simple Blink sketch example:

```
// the setup function runs once when you press reset or power the board
void setup() {
  // initialize digital pin 13 as an output.
  pinMode(13, OUTPUT);
}
```

```
// the loop function runs over and over again forever
void loop() {
  digitalWrite(13, HIGH); // turn the LED on (HIGH is the voltage level)
  delay(1000);           // wait for a second
  digitalWrite(13, LOW); // turn the LED off by making the voltage LOW
  delay(1000);           // wait for a second
}
```

Make sure the LED(s) are still green, then click Upload to upload Blink. Once it has uploaded successfully, the serial Port will change so re-select the new Port!

Once Blink is uploaded you should no longer need to double-click to enter bootloader mode. Arduino will automatically reset when you upload.

---

## Welcome to the Community!

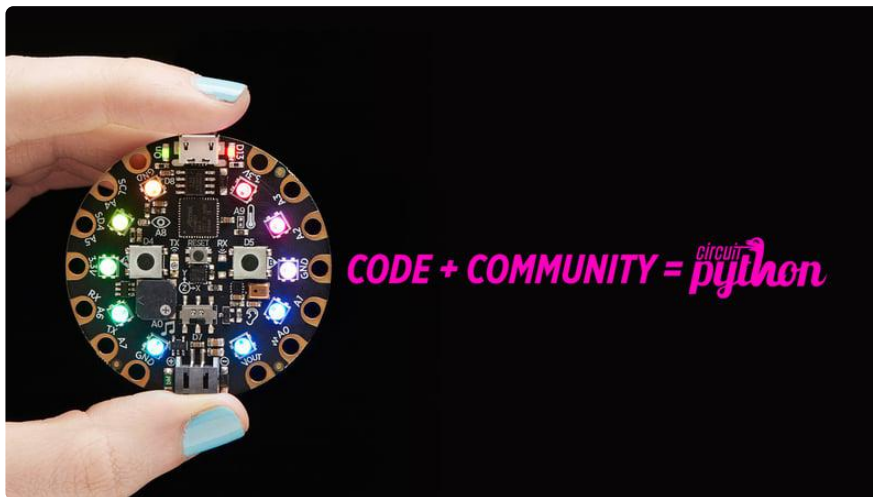

CircuitPython is a programming language that's super simple to get started with and great for learning. It runs on microcontrollers and works out of the box. You can plug it in and get started with any text editor. The best part? CircuitPython comes with an amazing, supportive community.

Everyone is welcome! CircuitPython is Open Source. This means it's available for anyone to use, edit, copy and improve upon. This also means CircuitPython becomes better because of you being a part of it. Whether this is your first microcontroller board or you're a seasoned software engineer, you have something important to offer the Adafruit CircuitPython community. This page highlights some of the many ways you can be a part of it!

# Adafruit Discord

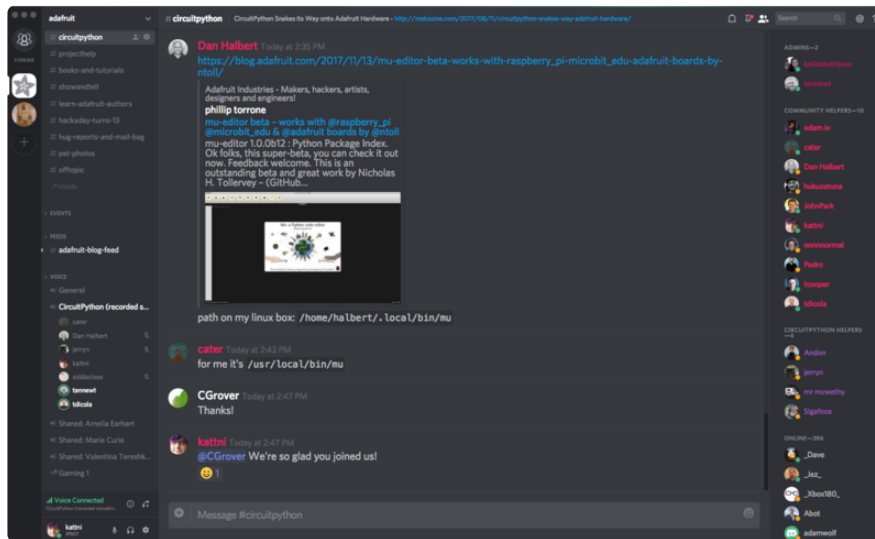

The Adafruit Discord server is the best place to start. Discord is where the community comes together to volunteer and provide live support of all kinds. From general discussion to detailed problem solving, and everything in between, Discord is a digital maker space with makers from around the world.

There are many different channels so you can choose the one best suited to your needs. Each channel is shown on Discord as "#channelname". There's the #help-with-projects channel for assistance with your current project or help coming up with ideas for your next one. There's the #show-and-tell channel for showing off your newest creation. Don't be afraid to ask a question in any channel! If you're unsure, #general is a great place to start. If another channel is more likely to provide you with a better answer, someone will guide you.

The help with CircuitPython channel is where to go with your CircuitPython questions. #help-with-circuitpython is there for new users and developers alike so feel free to ask a question or post a comment! Everyone of any experience level is welcome to join in on the conversation. Your contributions are important! The #circuitpython-dev channel is available for development discussions as well.

The easiest way to contribute to the community is to assist others on Discord. Supporting others doesn't always mean answering questions. Join in celebrating successes! Celebrate your mistakes! Sometimes just hearing that someone else has gone through a similar struggle can be enough to keep a maker moving forward.

The Adafruit Discord is the 24x7x365 hackerspace that you can bring your granddaughter to.

Visit <https://adafru.it/discord> () to sign up for Discord. Everyone is looking forward to meeting you!

## CircuitPython.org

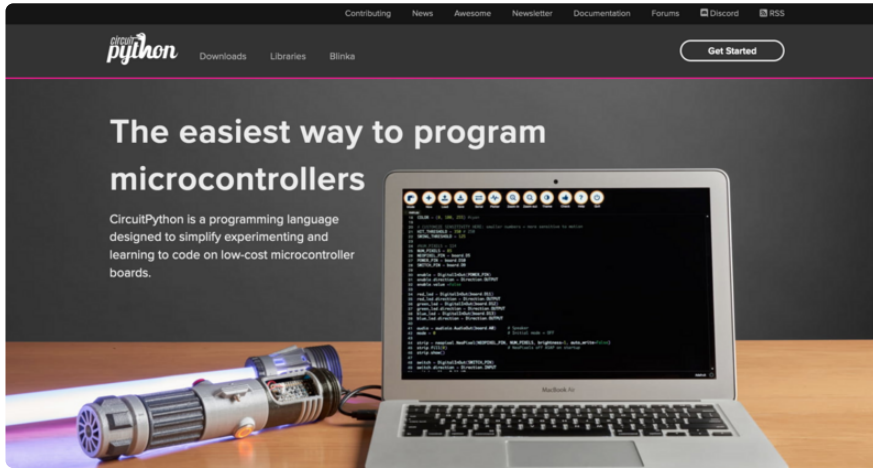

Beyond the Adafruit Learn System, which you are viewing right now, the best place to find information about CircuitPython is [circuitpython.org](https://circuitpython.org) (). Everything you need to get started with your new microcontroller and beyond is available. You can do things like [download CircuitPython for your microcontroller](#) () or [download the latest CircuitPython Library bundle](#) (), or check out [which single board computers support Blinka](#) (). You can also get to various other CircuitPython related things like Awesome CircuitPython or the Python for Microcontrollers newsletter. This is all incredibly useful, but it isn't necessarily community related. So why is it included here? The [Contributing page](#) ().

### Contributing

If you'd like to contribute to the CircuitPython project, the CircuitPython libraries are a great way to begin. This page is updated with daily status information from the CircuitPython libraries, including open pull requests, open issues and library infrastructure issues.

Do you write a language other than English? Another great way to contribute to the project is to contribute new localizations (translations) of CircuitPython, or update current localizations, using [Weblate](#).

If this is your first time contributing, or you'd like to see our recommended contribution workflow, we have a guide on [Contributing to CircuitPython with Git and Github](#). You can also find us in the [#circuitpython](#) channel on the [Adafruit Discord](#).

Have an idea for a new driver or library? [File an issue on the CircuitPython repo!](#)

CircuitPython itself is written in C. However, all of the Adafruit CircuitPython libraries are written in Python. If you're interested in contributing to CircuitPython on the Python side of things, check out [circuitpython.org/contributing](https://circuitpython.org/contributing) (). You'll find information pertaining to every Adafruit CircuitPython library GitHub repository, giving you the opportunity to join the community by finding a contributing option that works for you.

Note the date on the page next to Current Status for:

# Current Status for Tue, Nov 02, 2021

---

If you submit any contributions to the libraries, and do not see them reflected on the Contributing page, it could be that the job that checks for new updates hasn't yet run for today. Simply check back tomorrow!

Now, a look at the different options.

## Pull Requests

The first tab you'll find is a list of open pull requests.



**Pull Requests**   **Open Issues**   **Library Infrastructure Issues**   **CircuitPython Localization**

This is the current status of open pull requests and issues across all of the library repos.

**Open Pull Requests**

- Adafruit\_CircuitPython\_AdafruitIO
  - [Call `wifi.connect\(\)` after `wifi.reset\(\)`](#) (Open 113 days)
- Adafruit\_CircuitPython\_ADS1x15
  - [Supress f-string recommendation in `.pylintrc`](#) (Open 1 days)
- Adafruit\_CircuitPython\_ADT7410
  - [Adding critical temp features](#) (Open 168 days)

GitHub pull requests, or PRs, are opened when folks have added something to an Adafruit CircuitPython library GitHub repo, and are asking for Adafruit to add, or merge, their changes into the main library code. For PRs to be merged, they must first be reviewed. Reviewing is a great way to contribute! Take a look at the list of open pull requests, and pick one that interests you. If you have the hardware, you can test code changes. If you don't, you can still check the code updates for syntax. In the case of documentation updates, you can verify the information, or check it for spelling and grammar. Once you've checked out the update, you can leave a comment letting us know that you took a look. Once you've done that for a while, and you're more comfortable with it, you can consider joining the CircuitPythonLibrarians review team. The more reviewers we have, the more authors we can support. Reviewing is a crucial part of an open source ecosystem, CircuitPython included.

## Open Issues

The second tab you'll find is a list of open issues.

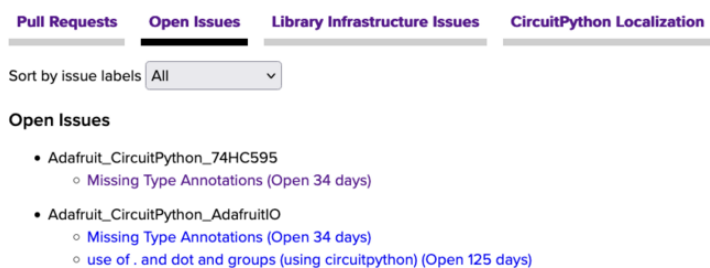

GitHub issues are filed for a number of reasons, including when there is a bug in the library or example code, or when someone wants to make a feature request. Issues are a great way to find an opportunity to contribute directly to the libraries by updating code or documentation. If you're interested in contributing code or documentation, take a look at the open issues and find one that interests you.

If you're not sure where to start, you can search the issues by label. Labels are applied to issues to make the goal easier to identify at a first glance, or to indicate the difficulty level of the issue. Click on the dropdown next to "Sort by issue labels" to see the list of available labels, and click on one to choose it.

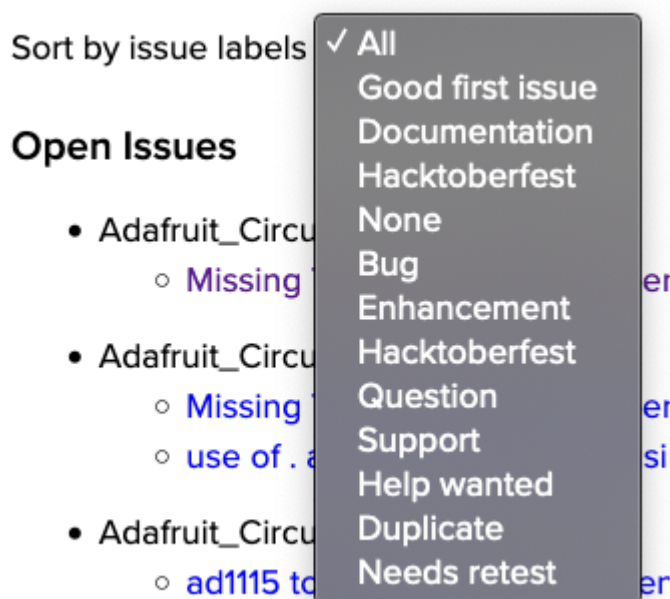

If you're new to everything, new to contributing to open source, or new to contributing to the CircuitPython project, you can choose "Good first issue". Issues with that label are well defined, with a finite scope, and are intended to be easy for someone new to figure out.

If you're looking for something a little more complicated, consider "Bug" or "Enhancement". The Bug label is applied to issues that pertain to problems or failures found in the library. The Enhancement label is applied to feature requests.

Don't let the process intimidate you. If you're new to Git and GitHub, there is [a guide](#) () to walk you through the entire process. As well, there are always folks available on [Discord](#) () to answer questions.

## Library Infrastructure Issues

The third tab you'll find is a list of library infrastructure issues.

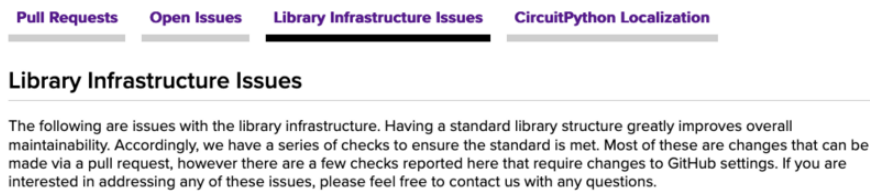

This section is generated by a script that runs checks on the libraries, and then reports back where there may be issues. It is made up of a list of subsections each containing links to the repositories that are experiencing that particular issue. This page is available mostly for internal use, but you may find some opportunities to contribute on this page. If there's an issue listed that sounds like something you could help with, mention it on Discord, or file an issue on GitHub indicating you're working to resolve that issue. Others can reply either way to let you know what the scope of it might be, and help you resolve it if necessary.

## CircuitPython Localization

The fourth tab you'll find is the CircuitPython Localization tab.

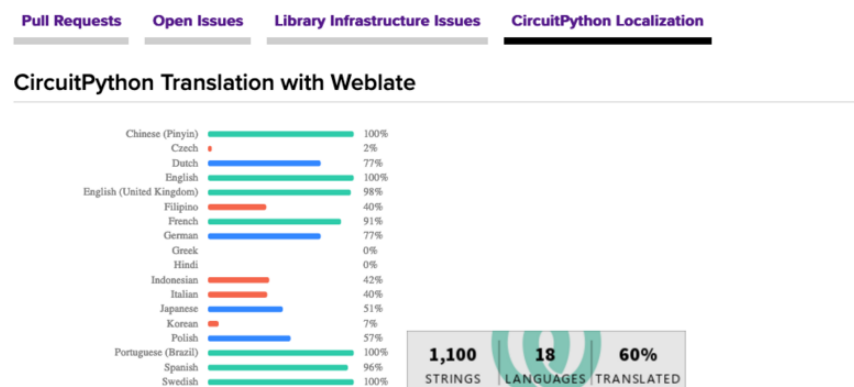

If you speak another language, you can help translate CircuitPython! The translations apply to informational and error messages that are within the CircuitPython core. It means that folks who do not speak English have the opportunity to have these messages shown to them in their own language when using CircuitPython. This is incredibly important to provide the best experience possible for all users.

CircuitPython uses Weblate to translate, which makes it much simpler to contribute translations. You will still need to know some CircuitPython-specific practices and a few basics about coding strings, but as with any CircuitPython contributions, folks are there to help.

Regardless of your skill level, or how you want to contribute to the CircuitPython project, there is an opportunity available. The [Contributing page \(\)](#) is an excellent place to start!

## Adafruit GitHub

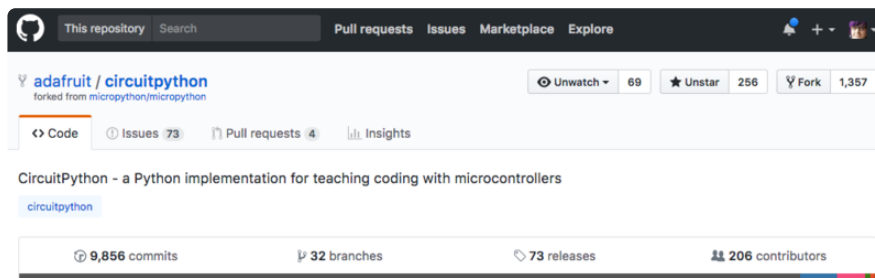

Whether you're just beginning or are life-long programmer who would like to contribute, there are ways for everyone to be a part of the CircuitPython project. The CircuitPython core is written in C. The libraries are written in Python. GitHub is the best source of ways to contribute to the [CircuitPython core \(\)](#), and the [CircuitPython libraries \(\)](#). If you need an account, visit [https://github.com/ \(\)](https://github.com/) and sign up.

If you're new to GitHub or programming in general, there are great opportunities for you. For the CircuitPython core, head over to the CircuitPython repository on GitHub, click on "[Issues \(\)](#)", and you'll find a list that includes issues labeled "[good first issue \(\)](#)". For the libraries, head over to the [Contributing page Issues list \(\)](#), and use the drop down menu to search for "[good first issue \(\)](#)". These issues are things that have been identified as something that someone with any level of experience can help with. These issues include options like updating documentation, providing feedback, and fixing simple bugs. If you need help getting started with GitHub, there is an excellent guide on [Contributing to CircuitPython with Git and GitHub \(\)](#).

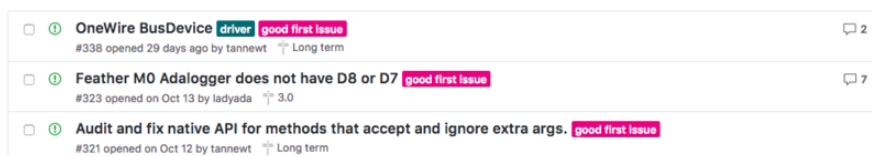

Already experienced and looking for a challenge? Checkout the rest of either issues list and you'll find plenty of ways to contribute. You'll find all sorts of things, from new driver requests, to library bugs, to core module updates. There's plenty of opportunities for everyone at any level!

When working with or using CircuitPython or the CircuitPython libraries, you may find problems. If you find a bug, that's great! The team loves bugs! Posting a detailed issue to GitHub is an invaluable way to contribute to improving CircuitPython. For CircuitPython itself, file an issue [here](#) (). For the libraries, file an issue on the specific library repository on GitHub. Be sure to include the steps to replicate the issue as well as any other information you think is relevant. The more detail, the better!

Testing new software is easy and incredibly helpful. Simply load the newest version of CircuitPython or a library onto your CircuitPython hardware, and use it. Let us know about any problems you find by posting a new issue to GitHub. Software testing on both stable and unstable releases is a very important part of contributing CircuitPython. The developers can't possibly find all the problems themselves! They need your help to make CircuitPython even better.

On GitHub, you can submit feature requests, provide feedback, report problems and much more. If you have questions, remember that Discord and the Forums are both there for help!

## Adafruit Forums

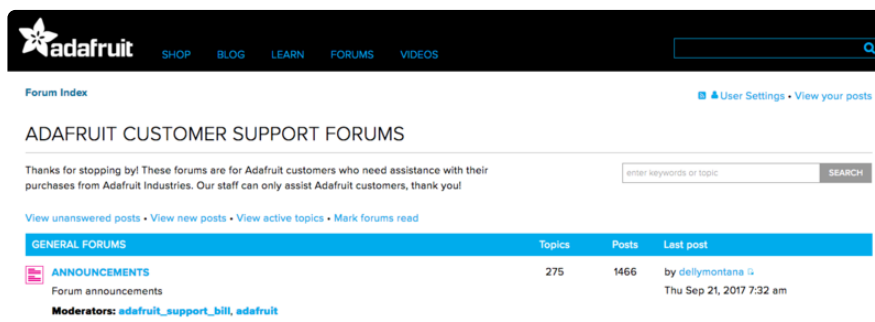

The [Adafruit Forums](#) () are the perfect place for support. Adafruit has wonderful paid support folks to answer any questions you may have. Whether your hardware is giving you issues or your code doesn't seem to be working, the forums are always there for you to ask. You need an Adafruit account to post to the forums. You can use the same account you use to order from Adafruit.

While Discord may provide you with quicker responses than the forums, the forums are a more reliable source of information. If you want to be certain you're getting an Adafruit-supported answer, the forums are the best place to be.

There are forum categories that cover all kinds of topics, including everything Adafruit. The [Adafruit CircuitPython](#) () category under "Supported Products & Projects" is the best place to post your CircuitPython questions.

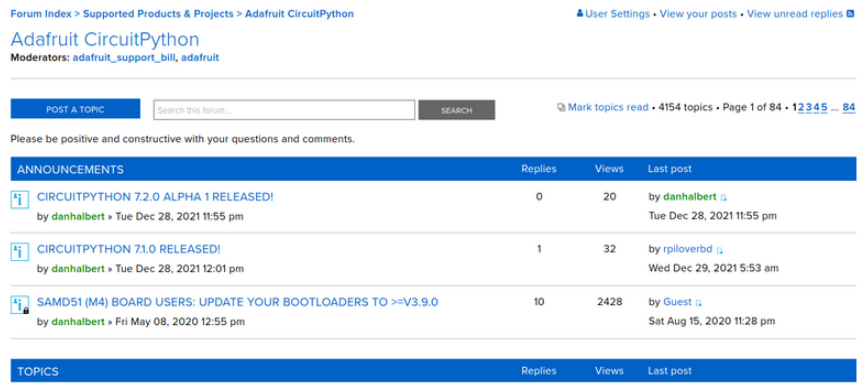

Be sure to include the steps you took to get to where you are. If it involves wiring, post a picture! If your code is giving you trouble, include your code in your post! These are great ways to make sure that there's enough information to help you with your issue.

You might think you're just getting started, but you definitely know something that someone else doesn't. The great thing about the forums is that you can help others too! Everyone is welcome and encouraged to provide constructive feedback to any of the posted questions. This is an excellent way to contribute to the community and share your knowledge!

## Read the Docs

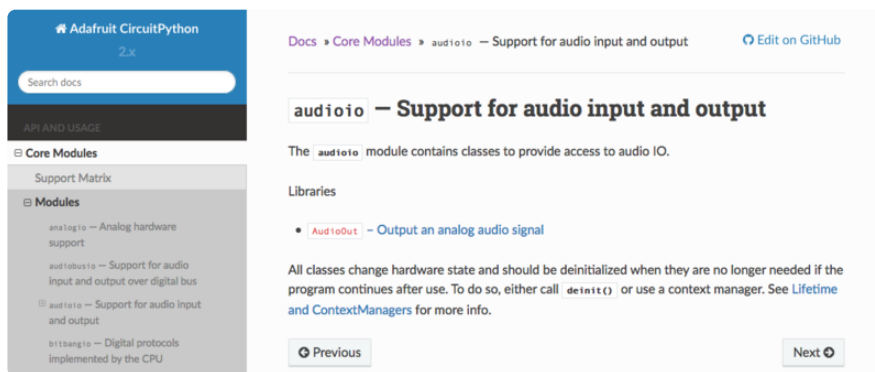

[Read the Docs \(\)](#) is an excellent resource for a more detailed look at the CircuitPython core and the CircuitPython libraries. This is where you'll find things like API documentation and example code. For an in depth look at viewing and understanding Read the Docs, check out the [CircuitPython Documentation \(\)](#) page!

Here is blinky:

```
import time
import digitalio
import board

led = digitalio.DigitalInOut(board.LED)
led.direction = digitalio.Direction.OUTPUT
while True:
    led.value = True
    time.sleep(0.1)
    led.value = False
    time.sleep(0.1)
```

---

## CircuitPython Made Easy

[CircuitPython Made Easy \(\)](#)

---

## CircuitPython Playground

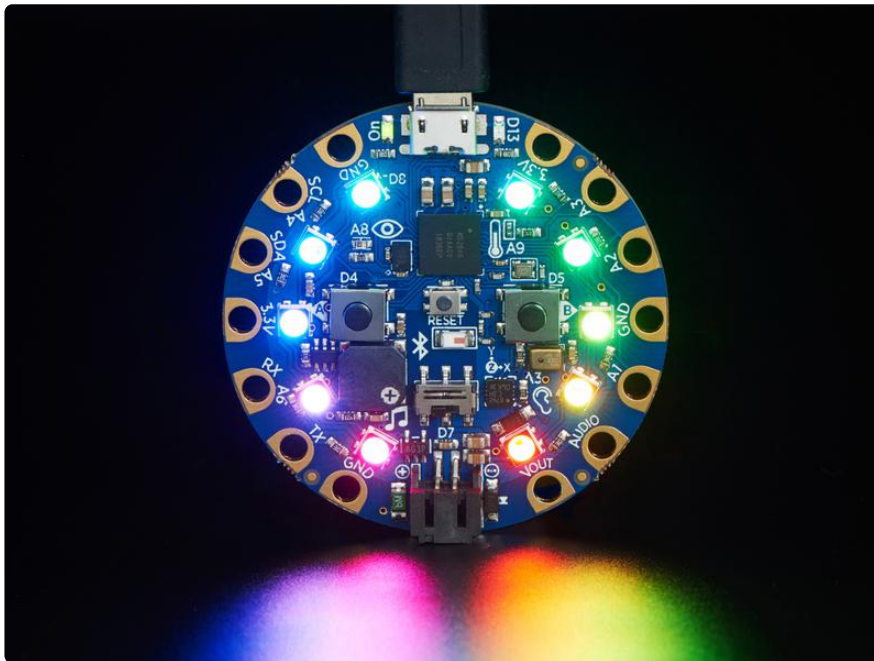

Here are examples of some of the many things you can do with the Circuit Playground Bluefruit with CircuitPython!

Many of the following examples are shown using Circuit Playground Express. The code works exactly the same way on the Circuit Playground Bluefruit. Simply copy the code and follow along with your Circuit Playground Bluefruit!

---

# CircuitPython Pins and Modules

CircuitPython is designed to run on microcontrollers and allows you to interface with all kinds of sensors, inputs and other hardware peripherals. There are tons of guides showing how to wire up a circuit, and use CircuitPython to, for example, read data from a sensor, or detect a button press. Most CircuitPython code includes hardware setup which requires various modules, such as `board` or `digitalio`. You import these modules and then use them in your code. How does CircuitPython know to look for hardware in the specific place you connected it, and where do these modules come from?

This page explains both. You'll learn how CircuitPython finds the pins on your microcontroller board, including how to find the available pins for your board and what each pin is named. You'll also learn about the modules built into CircuitPython, including how to find all the modules available for your board.

## CircuitPython Pins

When using hardware peripherals with a CircuitPython compatible microcontroller, you'll almost certainly be utilising pins. This section will cover how to access your board's pins using CircuitPython, how to discover what pins and board-specific objects are available in CircuitPython for your board, how to use the board-specific objects, and how to determine all available pin names for a given pin on your board.

### `import board`

When you're using any kind of hardware peripherals wired up to your microcontroller board, the import list in your code will include `import board`. The `board` module is built into CircuitPython, and is used to provide access to a series of board-specific objects, including pins. Take a look at your microcontroller board. You'll notice that next to the pins are pin labels. You can always access a pin by its pin label. However, there are almost always multiple names for a given pin.

To see all the available board-specific objects and pins for your board, enter the REPL (`>>>`) and run the following commands:

```
import board
dir(board)
```

Here is the output for the QT Py SAMD21. You may have a different board, and this list will vary, based on the board.

```
>>> import board
>>> dir(board)
['_class_', 'A0', 'A1', 'A10', 'A2', 'A3', 'A6', 'A7', 'A8', 'A9', 'D0', 'D1',
'D10', 'D2', 'D3', 'D4', 'D5', 'D6', 'D7', 'D8', 'D9', 'I2C', 'MISO', 'MOSI',
'NEOPIXEL', 'NEOPIXEL_POWER', 'RX', 'SCK', 'SCL', 'SDA', 'SPI', 'TX', 'UART']
```

The following pins have labels on the physical QT Py SAMD21 board: A0, A1, A2, A3, SDA, SCL, TX, RX, SCK, MISO, and MOSI. You see that there are many more entries available in `board` than the labels on the QT Py.

You can use the pin names on the physical board, regardless of whether they seem to be specific to a certain protocol.

For example, you do not have to use the SDA pin for I2C - you can use it for a button or LED.

On the flip side, there may be multiple names for one pin. For example, on the QT Py SAMD21, pin A0 is labeled on the physical board silkscreen, but it is available in CircuitPython as both `A0` and `D0`. For more information on finding all the names for a given pin, see the [What Are All the Available Pin Names? \(\)](#) section below.

The results of `dir(board)` for CircuitPython compatible boards will look similar to the results for the QT Py SAMD21 in terms of the pin names, e.g. A0, D0, etc. However, some boards, for example, the Metro ESP32-S2, have different styled pin names. Here is the output for the Metro ESP32-S2.

```
>>> import board
>>> dir(board)
['_class_', 'A0', 'A1', 'A2', 'A3', 'A4', 'A5', 'DEBUG_RX', 'DEBUG_TX', 'I2C',
'IO1', 'IO10', 'IO11', 'IO12', 'IO13', 'IO14', 'IO15', 'IO16', 'IO17', 'IO18',
'IO2', 'IO21', 'IO3', 'IO33', 'IO34', 'IO35', 'IO36', 'IO37', 'IO4', 'IO42', 'IO
45', 'IO5', 'IO6', 'IO7', 'IO8', 'IO9', 'LED', 'MISO', 'MOSI', 'NEOPIXEL', 'RX',
'SCK', 'SCL', 'SDA', 'SPI', 'TX', 'UART']
```

Note that most of the pins are named in an IO# style, such as IO1 and IO2. Those pins on the physical board are labeled only with a number, so an easy way to know how to access them in CircuitPython, is to run those commands in the REPL and find the pin naming scheme.

If your code is failing to run because it can't find a pin name you provided, verify that you have the proper pin name by running these commands in the REPL.

## I2C, SPI, and UART

You'll also see there are often (but not always!) three special board-specific objects included: `I2C`, `SPI`, and `UART` - each one is for the default pin-set used for each of the three common protocol busses they are named for. These are called singletons.

What's a singleton? When you create an object in CircuitPython, you are instantiating ('creating') it. Instantiating an object means you are creating an instance of the object with the unique values that are provided, or "passed", to it.

For example, When you instantiate an I2C object using the `busio` module, it expects two pins: clock and data, typically SCL and SDA. It often looks like this:

```
i2c = busio.I2C(board.SCL, board.SDA)
```

Then, you pass the I2C object to a driver for the hardware you're using. For example, if you were using the TSL2591 light sensor and its CircuitPython library, the next line of code would be:

```
tsl2591 = adafruit_tsl2591.TSL2591(i2c)
```

However, CircuitPython makes this simpler by including the `I2C` singleton in the `board` module. Instead of the two lines of code above, you simply provide the singleton as the I2C object. So if you were using the TSL2591 and its CircuitPython library, the two above lines of code would be replaced with:

```
tsl2591 = adafruit_tsl2591.TSL2591(board.I2C())
```

The `board.I2C()`, `board.SPI()`, and `board.UART()` singletons do not exist on all boards. They exist if there are board markings for the default pins for those devices.

This eliminates the need for the `busio` module, and simplifies the code. Behind the scenes, the `board.I2C()` object is instantiated when you call it, but not before, and on subsequent calls, it returns the same object. Basically, it does not create an object until you need it, and provides the same object every time you need it. You can call `board.I2C()` as many times as you like, and it will always return the same object.

The UART/SPI/I2C singletons will use the 'default' bus pins for each board - often labeled as RX/TX (UART), MOSI/MISO/SCK (SPI), or SDA/SCL (I2C). Check your board documentation/pinout for the default busses.

## What Are All the Available Names?

Many pins on CircuitPython compatible microcontroller boards have multiple names, however, typically, there's only one name labeled on the physical board. So how do you find out what the other available pin names are? Simple, with the following script! Each line printed out to the serial console contains the set of names for a particular pin.

On a microcontroller board running CircuitPython, first, connect to the serial console.

In the example below, click the Download Project Bundle button below to download the necessary libraries and the code.py file in a zip file. Extract the contents of the zip file, open the directory CircuitPython\_Essentials/Pin\_Map\_Script/ and then click on the directory that matches the version of CircuitPython you're using and copy the contents of that directory to your CIRCUITPY drive.

Your CIRCUITPY drive should now look similar to the following image:

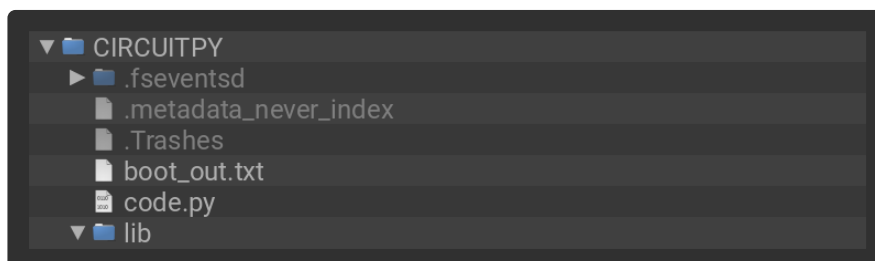

```
# SPDX-FileCopyrightText: 2020 anecdota for Adafruit Industries
# SPDX-FileCopyrightText: 2021 Neradoc for Adafruit Industries
# SPDX-FileCopyrightText: 2021-2023 Kattni Rembor for Adafruit Industries
# SPDX-FileCopyrightText: 2023 Dan Halbert for Adafruit Industries
#
# SPDX-License-Identifier: MIT

"""CircuitPython Essentials Pin Map Script"""
import microcontroller
import board
try:
    import cyw43 # raspberrypi
except ImportError:
    cyw43 = None

board_pins = []
for pin in dir(microcontroller.pin):
    if (isinstance(getattr(microcontroller.pin, pin), microcontroller.Pin) or
        (cyw43 and isinstance(getattr(microcontroller.pin, pin), cyw43.CywPin))):
        pins = []
```

```

for alias in dir(board):
    if getattr(board, alias) is getattr(microcontroller.pin, pin):
        pins.append(f"board.{alias}")
# Add the original GPIO name, in parentheses.
if pins:
    # Only include pins that are in board.
    pins.append(f"({str(pin)})")
    board_pins.append(" ".join(pins))

for pins in sorted(board_pins):
    print(pins)

```

Here is the result when this script is run on QT Py SAMD21:

```

code.py output:
board.A0 board.D0 (PA02)
board.A1 board.D1 (PA03)
board.A10 board.D10 board.MOSI (PA10)
board.A2 board.D2 (PA04)
board.A3 board.D3 (PA05)
board.A6 board.D6 board.TX (PA06)
board.A7 board.D7 board.RX (PA07)
board.A8 board.D8 board.SCK (PA11)
board.A9 board.D9 board.MISO (PA09)
board.D4 board.SDA (PA16)
board.D5 board.SCL (PA17)
board.NEOPIXEL (PA18)
board.NEOPIXEL_POWER (PA15)

```

Each line represents a single pin. Find the line containing the pin name that's labeled on the physical board, and you'll find the other names available for that pin. For example, the first pin on the board is labeled A0. The first line in the output is `board.A0 board.D0 (PA02)`. This means that you can access pin A0 in CircuitPython using both `board.A0` and `board.D0`.

The pins in parentheses are the microcontroller pin names. See the next section for more info on those.

You'll notice there are two "pins" that aren't labeled on the board but appear in the list: `board.NEOPIXEL` and `board.NEOPIXEL_POWER`. Many boards have several of these special pins that give you access to built-in board hardware, such as an LED or an on-board sensor. The QT Py SAMD21 only has one on-board extra piece of hardware, a NeoPixel LED, so there's only the one available in the list. But you can also control whether or not power is applied to the NeoPixel, so there's a separate pin for that.

That's all there is to figuring out the available names for a pin on a compatible microcontroller board in CircuitPython!

## Microcontroller Pin Names

The pin names available to you in the CircuitPython `board` module are not the same as the names of the pins on the microcontroller itself. The board pin names are

aliases to the microcontroller pin names. If you look at the datasheet for your microcontroller, you'll likely find a pinout with a series of pin names, such as "PA18" or "GPIO5". If you want to get to the actual microcontroller pin name in CircuitPython, you'll need the `microcontroller.pin` module. As with `board`, you can run `dir(microcontroller.pin)` in the REPL to receive a list of the microcontroller pin names.

```
>>> import microcontroller
>>> dir(microcontroller.pin)
['_class_', 'PA02', 'PA03', 'PA04', 'PA05', 'PA06', 'PA07', 'PA08', 'PA09',
'PA10', 'PA11', 'PA15', 'PA16', 'PA17', 'PA18', 'PA19', 'PA22', 'PA23']
```

## CircuitPython Built-In Modules

There is a set of modules used in most CircuitPython programs. One or more of these modules is always used in projects involving hardware. Often hardware requires installing a separate library from the Adafruit CircuitPython Bundle. But, if you try to find `board` or `digitalio` in the same bundle, you'll come up lacking. So, where do these modules come from? They're built into CircuitPython! You can find an comprehensive list of built-in CircuitPython modules and the technical details of their functionality from CircuitPython [here \(\)](#) and the Python-like modules included [here \(\)](#). However, not every module is available for every board due to size constraints or hardware limitations. How do you find out what modules are available for your board?

There are two options for this. You can check the [support matrix \(\)](#), and search for your board by name. Or, you can use the REPL.

Plug in your board, connect to the serial console and enter the REPL. Type the following command.

```
help("modules")
```

```
>>> help("modules")
__main__      collections  neopixel_write  supervisor
_pixelbuf     digitalio    os               sys
adafruit_bus_device  displayio      pulseio         terminalio
analogio      errno       pwmio           time
array         fontio      random          touchio
audiocore     gamepad     re             usb_hid
audioio       gc          rotaryio       usb_midi
board         math        rtc            vectorio
builtins      microcontroller  storage
busio        micropython  struct
Plus any modules on the filesystem
```

That's it! You now know two ways to find all of the modules built into CircuitPython for your compatible microcontroller board.

---

# CircuitPython Built-Ins

CircuitPython comes 'with the kitchen sink' - a lot of the things you know and love about classic Python 3 (sometimes called CPython) already work. There are a few things that don't but we'll try to keep this list updated as we add more capabilities!

This is not an exhaustive list! It's simply some of the many features you can use.

## Thing That Are Built In and Work

### Flow Control

All the usual `if`, `elif`, `else`, `for`, `while` work just as expected.

### Math

`import math` will give you a range of handy mathematical functions.

```
>>> dir(math)
['__name__', 'e', 'pi', 'sqrt', 'pow', 'exp', 'log', 'cos', 'sin',
'tan', 'acos', 'asin', 'atan', 'atan2', 'ceil', 'copysign', 'fabs',
'floor', 'fmod', 'frexp', 'ldexp', 'modf', 'isfinite', 'isinf',
'isnan', 'trunc', 'radians', 'degrees']
```

CircuitPython supports 30-bit wide floating point values so you can use `int` and `float` whenever you expect.

### Tuples, Lists, Arrays, and Dictionaries

You can organize data in `()`, `[]`, and `{}` including strings, objects, floats, etc.

### Classes, Objects and Functions

We use objects and functions extensively in our libraries so check out one of our many examples like this [MCP9808 library \(\)](#) for class examples.

## Lambdas

Yep! You can create function-functions with `lambda` just the way you like em:

```
>>> g = lambda x: x**2
>>> g(8)
64
```

## Random Numbers

To obtain random numbers:

```
import random
```

`random.random()` will give a floating point number from `0` to `1.0`.

`random.randint(min, max)` will give you an integer number between `min` and `max`.

---

## CircuitPython Digital In & Out

Though the following example uses the Circuit Playground Express to demonstrate, the code works exactly the same way with the Circuit Playground Bluefruit. Simply copy the code and follow along with your Circuit Playground Bluefruit!

The first part of interfacing with hardware is being able to manage digital inputs and outputs. With Circuitpython it's super easy!

This quick-start example shows how you can use one of the Circuit Playground Express buttons as an input to control another digital output - the built in LED

In the example below, click the Download Project Bundle button below to download the necessary files in a zip file. Extract the contents of the zip file, open the directory `Introducing_CircuitPlaygroundExpress/CircuitPlaygroundExpress_DigitalIO/` and then click on the directory that matches the version of CircuitPython you're using and copy `code.py` to your CIRCUITPY drive.

Your CIRCUITPY drive should now look similar to the following image:

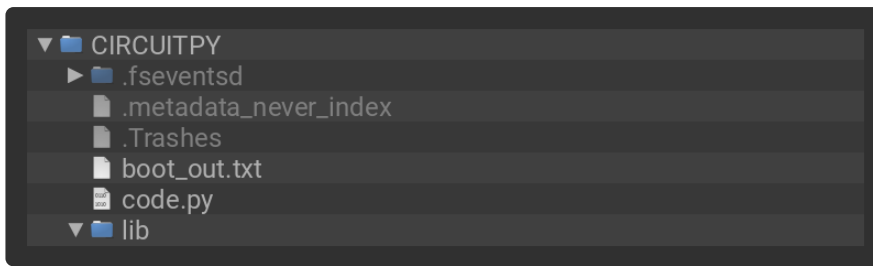

```
# SPDX-FileCopyrightText: 2017 Limor Fried for Adafruit Industries
#
# SPDX-License-Identifier: MIT

# Circuit Playground digitalio example

import time
import board
import digitalio

led = digitalio.DigitalInOut(board.D13)
led.switch_to_output()

button = digitalio.DigitalInOut(board.BUTTON_A)
button.switch_to_input(pull=digitalio.Pull.DOWN)

while True:
    if button.value: # button is pushed
        led.value = True
    else:
        led.value = False

    time.sleep(0.01)
```

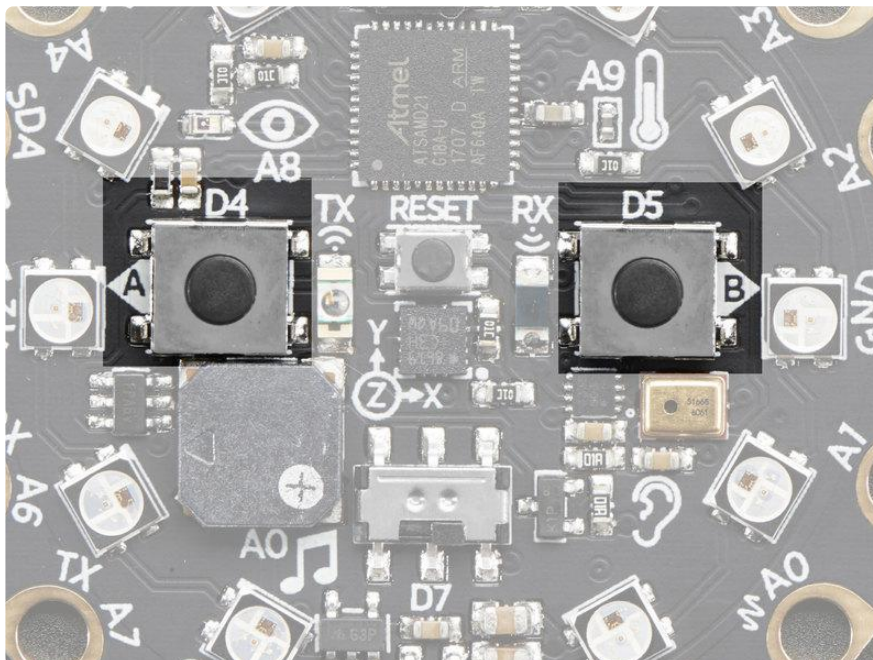

We're using the built-in pushbuttons in this example because it's very easy to get started, but you can use ALL KINDS of different buttons and switches, even homemade ones such as tinfoil or pennies, as digital inputs connected to the Digital IO pads!

Note that we made the code a little less 'pythonic' than necessary, the if/then could be replaced with a simple `led.value = not button.value` but I wanted to make it super clear how to test the inputs. When the interpreter gets to evaluating `button.value` that is when it will read the digital input.

Press Button A (the one on the left), and the onboard red LED will turn on!

Note that on the M0/SAMD based CircuitPython boards, at least, you can also have internal pullups with `Pull.UP` when using external buttons, but the built in buttons require `Pull.DOWN`.

Maybe you're setting up your own external button with pullup or pulldown resistor. If you want to turn off the internal pullup/pulldown simply include `button.switch_to_input()`.

## Going Beyond the Lesson!

It's time to flex your new learnings and try something different!!

### Experiment 1

See if you can adjust your code so that you use Button B instead of Button A.

It only takes a small change to switch buttons. If you get stuck, click on the blurry text below to reveal a hint and then the answer:

You need to change one single, solitary letter!

```
button = digitalio.DigitalInOut(board.BUTTON_B)
```

### Experiment 2

Perhaps you want to be sure there are no accidental illuminations of the red LED! Make it so that BOTH buttons must be pressed in order to light the red LED.

Hints:

You'll need to declare a variable for the second button, just as you did with the first. You'll also need to set it up as an input, with pull down resistance.

It's a good idea to rename the original button variable to `buttonA`, and the new set to `buttonB`.

To check both buttons in the 'if' statement, you'll use an 'and' to string together both value checks.

```
if buttonA.value == True and buttonB.value == True:
```

Experiment 3

Try testing the slide switch instead of the buttons. For the slide switch you need to use `Pull.UP` instead of `Pull.DOWN`.

Hints:

```
switch = digitalio.DigitalInOut(board.SLIDE_SWITCH)
switch.direction = digitalio.Direction.INPUT
switch.pull = digitalio.Pull.UP
```

```
if switch.value is True: # switch is slid to the left
```

---

## CircuitPython Analog In

Though the following example uses the Circuit Playground Express to demonstrate, the code works exactly the same way with the Circuit Playground Bluefruit. Simply copy the code and follow along with your Circuit Playground Bluefruit!

This quick-start example shows how you can read the analog voltage of a potentiometer connected to the Circuit Playground Express.

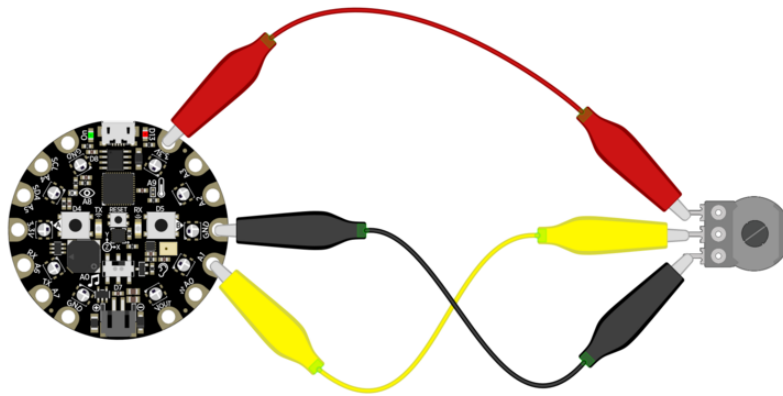

First, connect your potentiometer to the Circuit Playground Express using three alligator clip leads, as shown. The connections are:

- Left pot connection to 3.3V
- Center pot (wiper) to A1
- Right pot connection to GND

When you turn the knob of the potentiometer, the wiper rotates left and right, increasing or decreasing the resistance. This, in turn, changes the analog voltage level that will be read by the Circuit Playground Express on A1.

In the example below, click the Download Project Bundle button below to download the necessary files in a zip file. Extract the contents of the zip file, open the directory `Introducing_CircuitPlaygroundExpress/CircuitPlaygroundExpress_AnalogIn/` and then click on the directory that matches the version of CircuitPython you're using and copy `code.py` to your CIRCUITPY drive.

Your CIRCUITPY drive should now look similar to the following image:

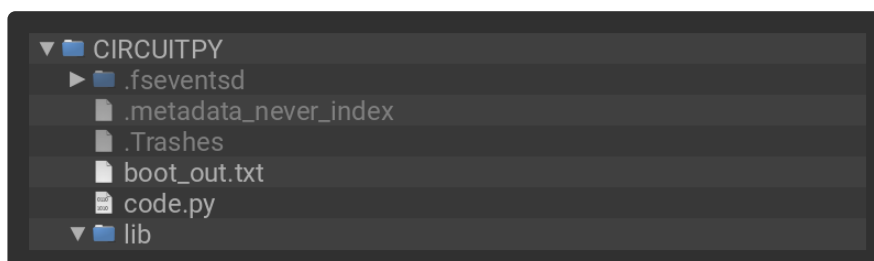

```
# SPDX-FileCopyrightText: 2017 John Edgar Park for Adafruit Industries
#
# SPDX-License-Identifier: MIT

# Circuit Playground AnalogIn
# Reads the analog voltage level from a 10k potentiometer connected to GND, 3.3V,
```

```
and pin A1
# and prints the results to the serial console.

import time
import board
import analogio

analogin = analogio.AnalogIn(board.A1)

def getVoltage(pin): # helper
    return (pin.value * 3.3) / 65536

while True:
    print("Analog Voltage: %f" % getVoltage(analogin))
    time.sleep(0.1)
```

## Creating an Analog Input

`analogin = analogio.AnalogIn(board.A1)` creates an object named `analogin` which is connected to the A1 pad on the Circuit Playground Express.

You can use many of different kinds of external analog sensors connected to the Analog IO pads, such as distance sensors, flex sensors, and more!!

## GetVoltage Helper

`getVoltage(pin)` is our little helper program. By default, analog readings will range from 0 (minimum) to 65535 (maximum). This helper will convert the 0-65535 reading from `pin.value` and convert it a 0-3.3V voltage reading.

## Main Loop

The main loop is simple, it will just print out the voltage as a floating point value (the `%f` indicates to print as floating point) by calling `getVoltage` on each of our analog object, in this case the potentiometer.

If you connect to the serial console, you'll see the voltage printed out. Try turning the knob of the potentiometer to see the voltage change!

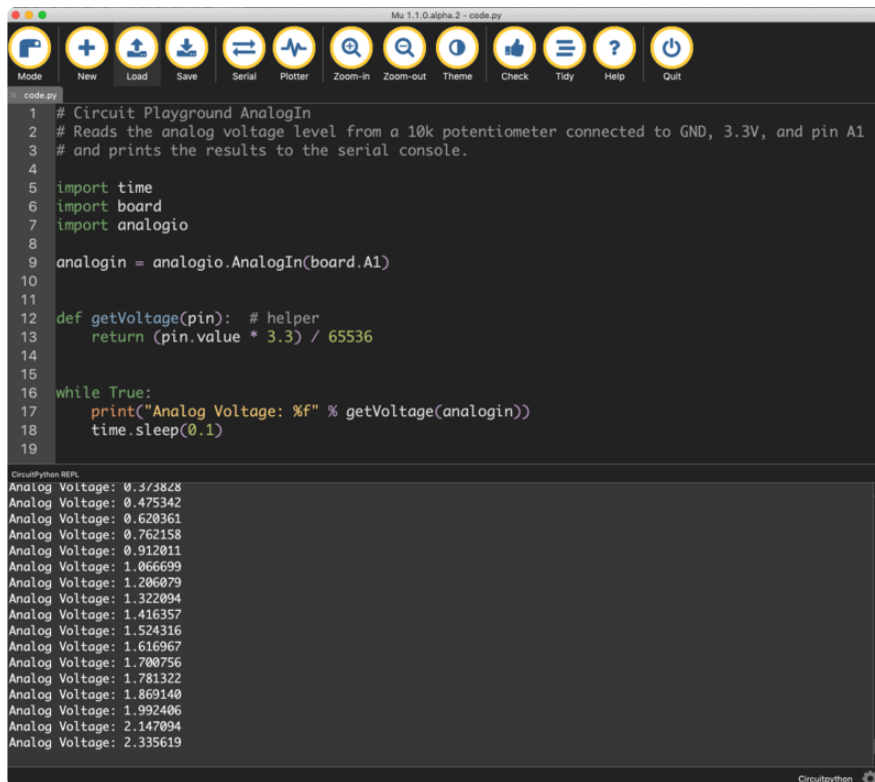

```
code.py
1 # Circuit Playground AnalogIn
2 # Reads the analog voltage level from a 10k potentiometer connected to GND, 3.3V, and pin A1
3 # and prints the results to the serial console.
4
5 import time
6 import board
7 import analogio
8
9 analogin = analogio.AnalogIn(board.A1)
10
11
12 def getVoltage(pin): # helper
13     return (pin.value * 3.3) / 65536
14
15
16 while True:
17     print("Analog Voltage: %F" % getVoltage(analogin))
18     time.sleep(0.1)
19
```

CircuitPython REPL

```
Analog Voltage: 0.373828
Analog Voltage: 0.475342
Analog Voltage: 0.620361
Analog Voltage: 0.762158
Analog Voltage: 0.912011
Analog Voltage: 1.066699
Analog Voltage: 1.206079
Analog Voltage: 1.322094
Analog Voltage: 1.416357
Analog Voltage: 1.524316
Analog Voltage: 1.616967
Analog Voltage: 1.700756
Analog Voltage: 1.781322
Analog Voltage: 1.869140
Analog Voltage: 1.992406
Analog Voltage: 2.147094
Analog Voltage: 2.335619
```

## CircuitPython Servo

In order to use servos, we take advantage of `pwmio`. Now, in theory, you could just use the raw `pwmio` calls to set the frequency to 50 Hz and then set the pulse widths. But we would rather make it a little more elegant and easy!

So, instead we will use `adafruit_motor` which manages servos for you quite nicely! `adafruit_motor` is a library so be sure to [grab it from the library bundle if you have not yet \(\)](#)! If you need help installing the library, check out the [CircuitPython Libraries page \(\)](#).

Servos come in two types:

- A standard hobby servo - the horn moves 180 degrees (90 degrees in each direction from zero degrees).
- A continuous servo - the horn moves in full rotation like a DC motor. Instead of an angle specified, you set a throttle value with 1.0 being full forward, 0.5 being half forward, 0 being stopped, and -1 being full reverse, with other values between.

## Servo Wiring

Servos will only work on PWM-capable pins! Check your board details to verify which pins have PWM outputs.

The connections for a servo are the same for standard servos and continuous rotation servos.

Connect the servo's brown or black ground wire to ground on the CircuitPython board.

Connect the servo's red power wire to 5V power, USB power is good for a servo or two. For more than that, you'll need an external battery pack. Do not use 3.3V for powering a servo!

Connect the servo's yellow or white signal wire to the control/data pin, in this case A1 or A2 but you can use any PWM-capable pin.

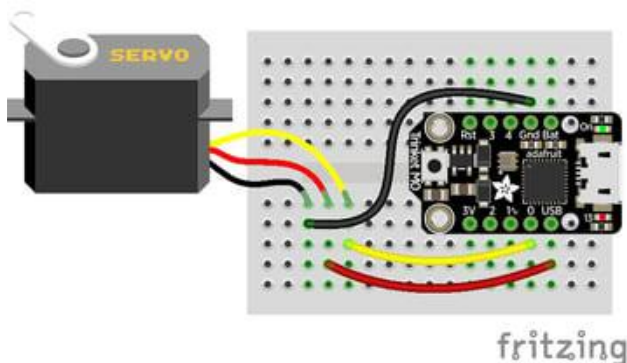

For example, to wire a servo to Trinket, connect the ground wire to GND, the power wire to USB, and the signal wire to 0.

Remember, A2 on Trinket is labeled "0".

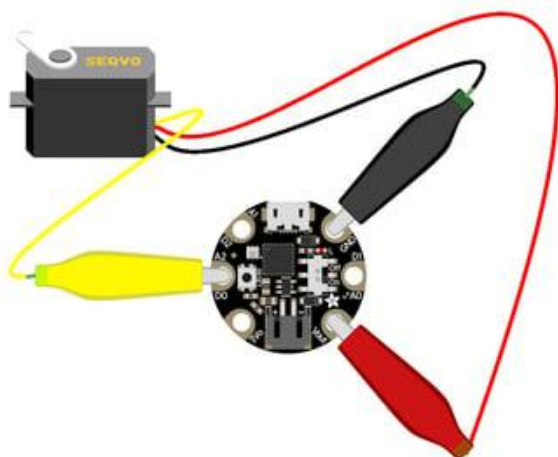

For Gemma, use jumper wire alligator clips to connect the ground wire to GND, the power wire to VOUT, and the signal wire to A2.

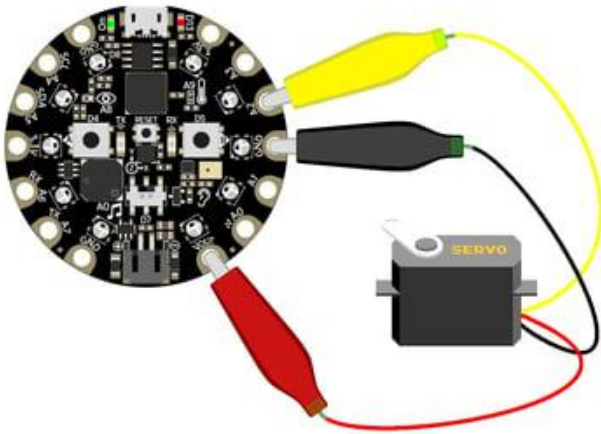

For Circuit Playground Express and Circuit Playground Bluefruit, use jumper wire alligator clips to connect the ground wire to GND, the power wire to VOUT, and the signal wire to A2.

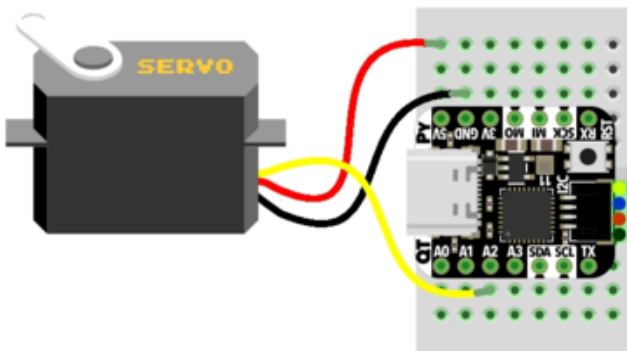

For QT Py M0, connect the ground wire to GND, the power wire to 5V, and the signal wire to A2.

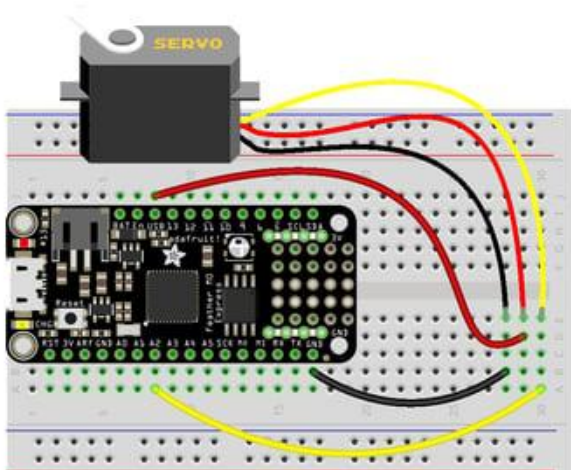

For boards like Feather M0 Express, ItsyBitsy M0 Express and Metro M0 Express, connect the ground wire to any GND, the power wire to USB or 5V, and the signal wire to A2.

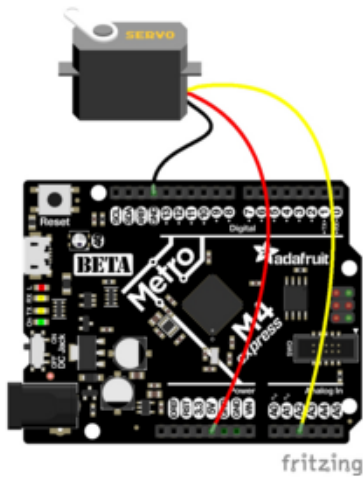

For the Metro M4 Express, ItsyBitsy M4 Express and the Feather M4 Express, connect the ground wire to any G or GND, the power wire to USB or 5V, and the signal wire to A2.

## Standard Servo Code

Here's an example that will sweep a servo connected to pin A2 from 0 degrees to 180 degrees (-90 to 90 degrees) and back.

To use with CircuitPython, you need to first install a few libraries, into the lib folder on your CIRCUITPY drive. Then you need to update code.py with the example script.

Thankfully, we can do this in one go. In the example below, click the Download Project Bundle button below to download the necessary libraries and the code.py file in a zip file. Extract the contents of the zip file, open the directory CircuitPython\_Essentials/CircuitPython\_Servo/ and then click on the directory that matches the version of CircuitPython you're using and copy the contents of that directory to your CIRCUITPY drive.

Your CIRCUITPY drive should now look similar to the following image:

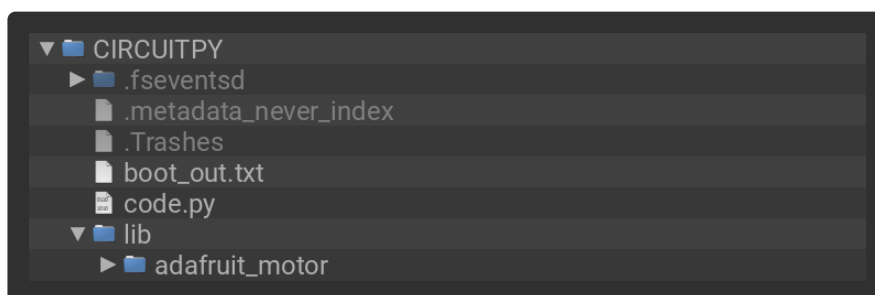

```
# SPDX-FileCopyrightText: 2018 Kattni Rembor for Adafruit Industries
#
# SPDX-License-Identifier: MIT

"""CircuitPython Essentials Servo standard servo example"""
import time
import board
import pwmio
from adafruit_motor import servo
```

```

# create a PWMOut object on Pin A2.
pwm = pwmio.PWMOut(board.A2, duty_cycle=2 ** 15, frequency=50)

# Create a servo object, my_servo.
my_servo = servo.Servo(pwm)

while True:
    for angle in range(0, 180, 5): # 0 - 180 degrees, 5 degrees at a time.
        my_servo.angle = angle
        time.sleep(0.05)
    for angle in range(180, 0, -5): # 180 - 0 degrees, 5 degrees at a time.
        my_servo.angle = angle
        time.sleep(0.05)

```

## Continuous Servo Code

There are two differences with Continuous Servos vs. Standard Servos:

1. The `servo` object is created like `my_servo = servo.ContinuousServo(pwm)` instead of `my_servo = servo.Servo(pwm)`
2. Instead of using `myservo.angle`, you use `my_servo.throttle` using a throttle value from 1.0 (full on) to 0.0 (stopped) to -1.0 (full reverse). Any number between would be a partial speed forward (positive) or reverse (negative). This is very similar to standard DC motor control with the `adafruit_motor` library.

This example runs full forward for 2 seconds, stops for 2 seconds, runs full reverse for 2 seconds, then stops for 4 seconds.

To use with CircuitPython, you need to first install a few libraries, into the `lib` folder on your CIRCUITPY drive. Then you need to update `code.py` with the example script.

Thankfully, we can do this in one go. In the example below, click the Download Project Bundle button below to download the necessary libraries and the `code.py` file in a zip file. Extract the contents of the zip file, open the directory `CircuitPython_Essentials/CircuitPython_Continuous_Servo/` and then click on the directory that matches the version of CircuitPython you're using and copy the contents of that directory to your CIRCUITPY drive.

Your CIRCUITPY drive should now look similar to the following image:

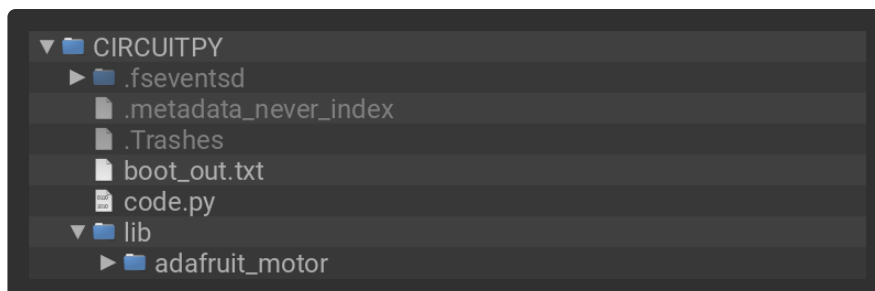

```

# SPDX-FileCopyrightText: 2019 Anne Barela for Adafruit Industries
#
# SPDX-License-Identifier: MIT

"""CircuitPython Essentials Servo continuous rotation servo example"""
import time
import board
import pwmio
from adafruit_motor import servo

# create a PWMOut object on Pin A2.
pwm = pwmio.PWMOut(board.A2, frequency=50)

# Create a servo object, my_servo.
my_servo = servo.ContinuousServo(pwm)

while True:
    print("forward")
    my_servo.throttle = 1.0
    time.sleep(2.0)
    print("stop")
    my_servo.throttle = 0.0
    time.sleep(2.0)
    print("reverse")
    my_servo.throttle = -1.0
    time.sleep(2.0)
    print("stop")
    my_servo.throttle = 0.0
    time.sleep(4.0)

```

Pretty simple!

Note that we assume that 0 degrees is 0.5ms and 180 degrees is a pulse width of 2.5ms. That's a bit wider than the official 1-2ms pulse widths. If you have a servo that has a different range you can initialize the `servo` object with a different `min_pulse` and `max_pulse`. For example:

```
my_servo = servo.Servo(pwm, min_pulse = 500, max_pulse = 2500)
```

For more detailed information on using servos with CircuitPython, check out the [CircuitPython section of the servo guide \(\)](#)!

## CircuitPython Audio Out

Though the following example uses the Circuit Playground Express to demonstrate, the code works exactly the same way with the Circuit Playground Bluefruit. Simply copy the code and follow along with your Circuit Playground Bluefruit!

The Circuit Playground Express has some nice built in audio output capabilities.

There are two ways to get audio output, one is via the small built in speaker. The other is by using alligator clips to connect a headphone or powered speaker to the A0/AUDIO pin.

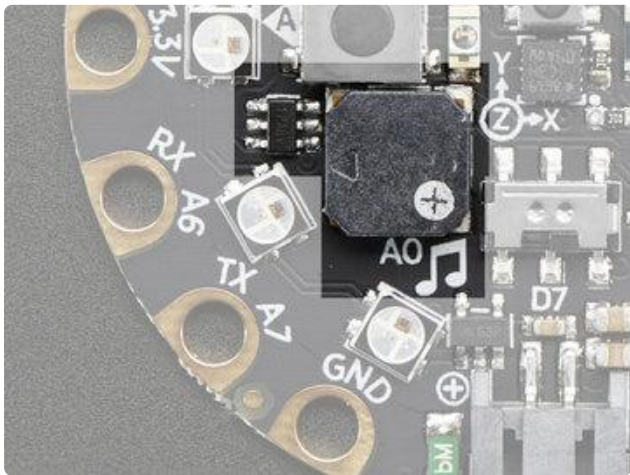

The speaker is over here, its small but can make some loud sounds! You can ENABLE or disable the speaker. If you disable the speaker, audio will only come out the A0/AUDIO pin. If you enable the speaker, audio will come out from both!

If you want to connect a speaker or headphones, use two alligator clips and connect GND to the sleeve of the headphone, and A0/AUDIO to the tip.

The A0/AUDIO pin cannot drive a speaker directly, please only connect headphones, or powered speakers!

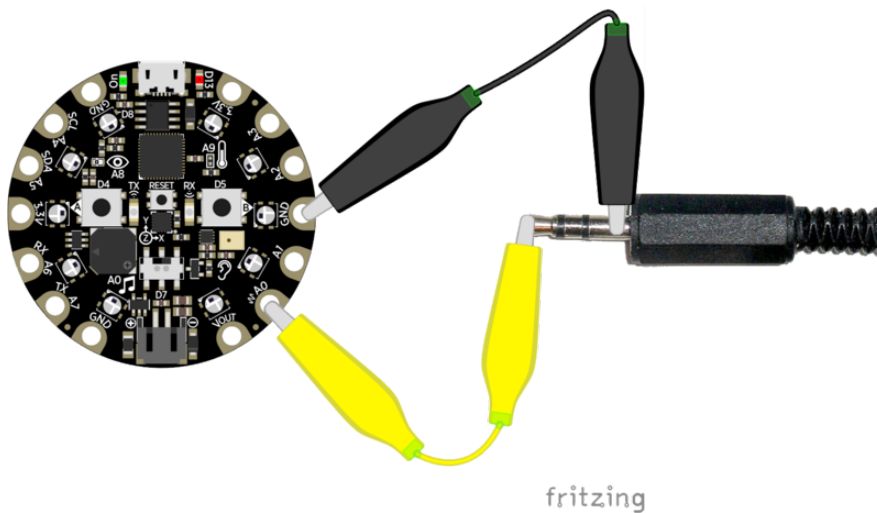

## Basic Tones

We can start by making simple tones. We will play sine waves. We first generate a single period of a sine wave in python, with the `math.sin` function, and stick it into `sine_wave`.

Then we enable the speaker by setting the `SPEAKER_ENABLE` pin to be an output and `True`.

We can create the audio object with this line that sets the output pin and the sine wave sample object and give it the sample array

```
audio = AudioOut(board.SPEAKER)
sine_wave_sample = RawSample(sine_wave)
```

Finally you can run `audio.play()` - if you only want to play the sample once, call as is. If you want it to loop the sample, which we definitely do so its one long tone, pass in `loop=True`

You can then do whatever you like, the tone will play in the background until you call `audio.stop()`

In the example below, click the Download Project Bundle button below to download the necessary files in a zip file. Extract the contents of the zip file, open the directory `Introducing_CircuitPlaygroundExpress/CircuitPlaygroundExpress_AudioSine/` and then click on the directory that matches the version of CircuitPython you're using and copy `code.py` to your CIRCUITPY drive.

Your CIRCUITPY drive should now look similar to the following image:

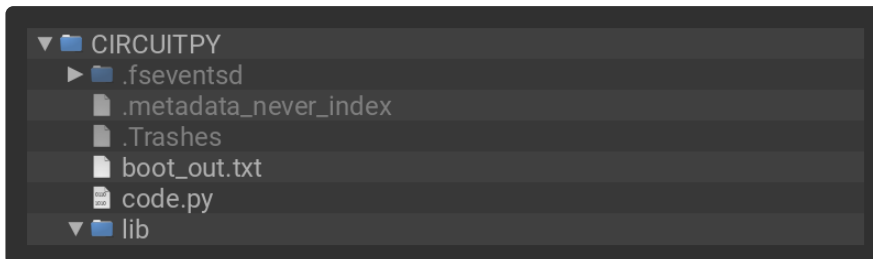

```
# SPDX-FileCopyrightText: 2017 Limor Fried for Adafruit Industries
#
# SPDX-License-Identifier: MIT

import time
import array
import math
import board
import digitalio

try:
    from audiocore import RawSample
except ImportError:
    from audioio import RawSample

try:
    from audioio import AudioOut
except ImportError:
```

```

try:
    from audiopwmio import PWMAudioOut as AudioOut
except ImportError:
    pass # not always supported by every board!

FREQUENCY = 440 # 440 Hz middle 'A'
SAMPLERATE = 8000 # 8000 samples/second, recommended!

# Generate one period of sine wav.
length = SAMPLERATE // FREQUENCY
sine_wave = array.array("H", [0] * length)
for i in range(length):
    sine_wave[i] = int(math.sin(math.pi * 2 * i / length) * (2 ** 15) + 2 ** 15)

# Enable the speaker
speaker_enable = digitalio.DigitalInOut(board.SPEAKER_ENABLE)
speaker_enable.direction = digitalio.Direction.OUTPUT
speaker_enable.value = True

audio = AudioOut(board.SPEAKER)
sine_wave_sample = RawSample(sine_wave)

# A single sine wave sample is hundredths of a second long. If you set loop=False,
it will play
# a single instance of the sample (a quick burst of sound) and then silence for the
rest of the
# duration of the time.sleep(). If loop=True, it will play the single instance of
the sample
# continuously for the duration of the time.sleep().
audio.play(sine_wave_sample, loop=True) # Play the single sine_wave sample
continuously...
time.sleep(1) # for the duration of the sleep (in seconds)
audio.stop() # and then stop.

```

## Playing Audio Files

Tones are lovely but lets play some music! You can drag-and-drop audio files onto the CIRCUITPY drive and then play them with a Python command

## Installing Project Code

To use with CircuitPython, you need to first install a few libraries, into the lib folder on your CIRCUITPY drive. Then you need to update code.py with the example script.

Thankfully, we can do this in one go. In the example below, click the Download Project Bundle button below to download the necessary libraries and the code.py file in a zip file. Extract the contents of the zip file, open the directory `Introducing_CircuitP laygroundExpress/CircuitPlaygroundExpress_AudioFiles/` and then click on the directory that matches the version of CircuitPython you're using and copy the contents of that directory to your CIRCUITPY drive.

Your CIRCUITPY drive should now look similar to the following image:



```
# SPDX-FileCopyrightText: 2017 Limor Fried for Adafruit Industries
#
# SPDX-License-Identifier: MIT

import board
import digitalio

try:
    from audiocore import WaveFile
except ImportError:
    from audioio import WaveFile

try:
    from audioio import AudioOut
except ImportError:
    try:
        from audiopwmio import PWMAudioOut as AudioOut
    except ImportError:
        pass # not always supported by every board!

# Enable the speaker
spkrenable = digitalio.DigitalInOut(board.SPEAKER_ENABLE)
spkrenable.direction = digitalio.Direction.OUTPUT
spkrenable.value = True

# Make the 2 input buttons
buttonA = digitalio.DigitalInOut(board.BUTTON_A)
buttonA.direction = digitalio.Direction.INPUT
buttonA.pull = digitalio.Pull.DOWN

buttonB = digitalio.DigitalInOut(board.BUTTON_B)
buttonB.direction = digitalio.Direction.INPUT
buttonB.pull = digitalio.Pull.DOWN

# The two files assigned to buttons A & B
audiofiles = ["rimshot.wav", "laugh.wav"]

def play_file(filename):
    print("Playing file: " + filename)
    wave_file = open(filename, "rb")
    with WaveFile(wave_file) as wave:
        with AudioOut(board.SPEAKER) as audio:
            audio.play(wave)
            while audio.playing:
                pass
    print("Finished")

while True:
    if buttonA.value:
        play_file(audiofiles[0])
    if buttonB.value:
        play_file(audiofiles[1])
```

This example creates two input buttons using the onboard buttons, then has a helper function that will:

1. open a file on the disk drive with `wave_file = open(filename, "rb")`
2. create the wave file object with `with WaveFile(wave_file) as wave:`
3. create the audio playback object with `with AudioOut(board.SPEAKER) as audio:`
4. and finally play it until its done:  
`audio.play(wave)`  
`while audio.playing:`  
`pass`

Upload the code then try pressing the two buttons one at a time to create your own laugh track!

If you want to use your own sound files, you can! Record, sample, remix, or simply download files from a sound file site, such as [freesample.org](https://freesample.org). Then, to make sure you have the files converted to the proper specifications, [check out this guide here \(\)](#) that I show you how! Spoiler alert: you'll need to make a small, 22Khz (or lower), 16 bit PCM, mono .wav file!

---

## CircuitPython Cap Touch

Though the following example uses the Circuit Playground Express to demonstrate, the code works exactly the same way with the Circuit Playground Bluefruit. Simply copy the code and follow along with your Circuit Playground Bluefruit!

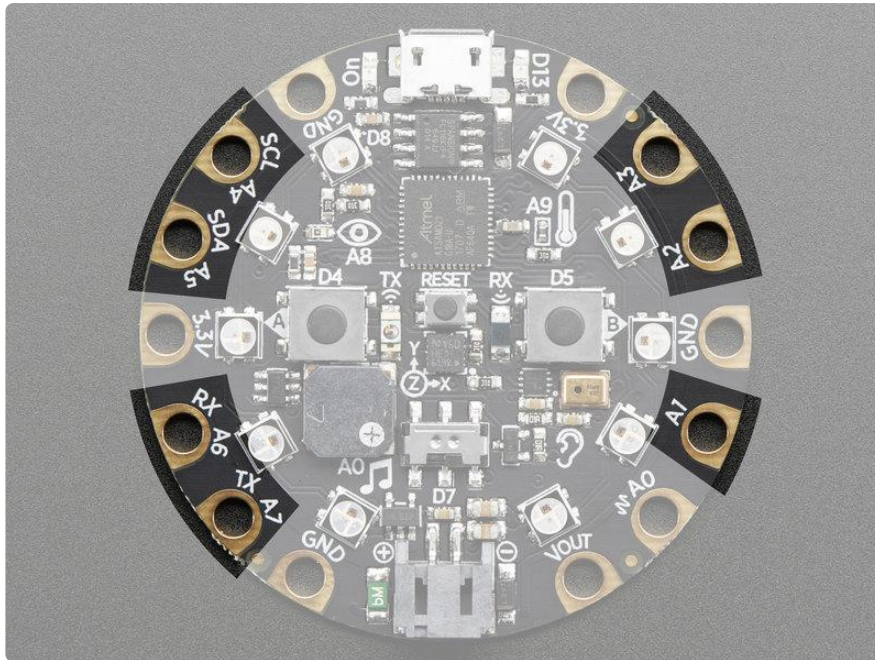

This quick-start example shows how you can read the capacitive touch sensors built into on seven of the Circuit Playground Express pads (pad A0/Audio is not a capacitive touch pad).

In the example below, click the Download Project Bundle button below to download the necessary files in a zip file. Extract the contents of the zip file, open the directory `Introducing_CircuitPlaygroundExpress/CircuitPlaygroundExpress_CapTouch/` and then click on the directory that matches the version of CircuitPython you're using and copy `code.py` to your CIRCUITPY drive.

Your CIRCUITPY drive should now look similar to the following image:

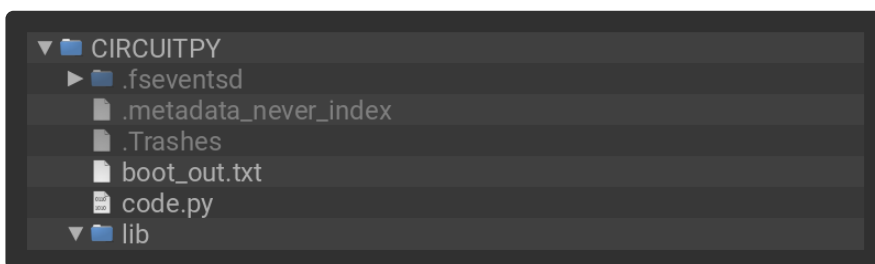

```
# SPDX-FileCopyrightText: 2017 John Edgar Park for Adafruit Industries
#
# SPDX-License-Identifier: MIT

# Circuit Playground Capacitive Touch

import time
import board
import touchio

touch_A1 = touchio.TouchIn(board.A1)
touch_A2 = touchio.TouchIn(board.A2)
touch_A3 = touchio.TouchIn(board.A3)
```

```
touch_A4 = touchio.TouchIn(board.A4)
touch_A5 = touchio.TouchIn(board.A5)
touch_A6 = touchio.TouchIn(board.A6)
touch_TX = touchio.TouchIn(board.TX)

while True:
    if touch_A1.value:
        print("A1 touched!")
    if touch_A2.value:
        print("A2 touched!")
    if touch_A3.value:
        print("A3 touched!")
    if touch_A4.value:
        print("A4 touched!")
    if touch_A5.value:
        print("A5 touched!")
    if touch_A6.value:
        print("A6 touched!")
    if touch_TX.value:
        print("TX touched!")

    time.sleep(0.01)
```

You can open up the serial console, then touch each touch pad to see the touches detected and printed out.

## Creating an capacitive touch input

Pads A1 - A6 and TX can be used as capacitive TouchIn devices:

```
touch_A1 = touchio.TouchIn(board.A1)
touch_A2 = touchio.TouchIn(board.A2)
touch_A3 = touchio.TouchIn(board.A3)
touch_A4 = touchio.TouchIn(board.A4)
touch_A5 = touchio.TouchIn(board.A5)
touch_A6 = touchio.TouchIn(board.A6)
touch_TX = touchio.TouchIn(board.TX)
```

This code creates seven objects, one connected to each of the cap touch pads.

## Main Loop

The main loop checks each sensor one after the other, to determine if it has been touched. If `touch_A1.value` returns True, that means that that pad, `A1`, detected a touch. For each pad, if it has been touched, a message will print.

A small sleep delay is added at the end so the loop doesn't run too fast. You may want to change the delay from 0.1 seconds to 0 seconds to slow it down or increase it to speed it up.

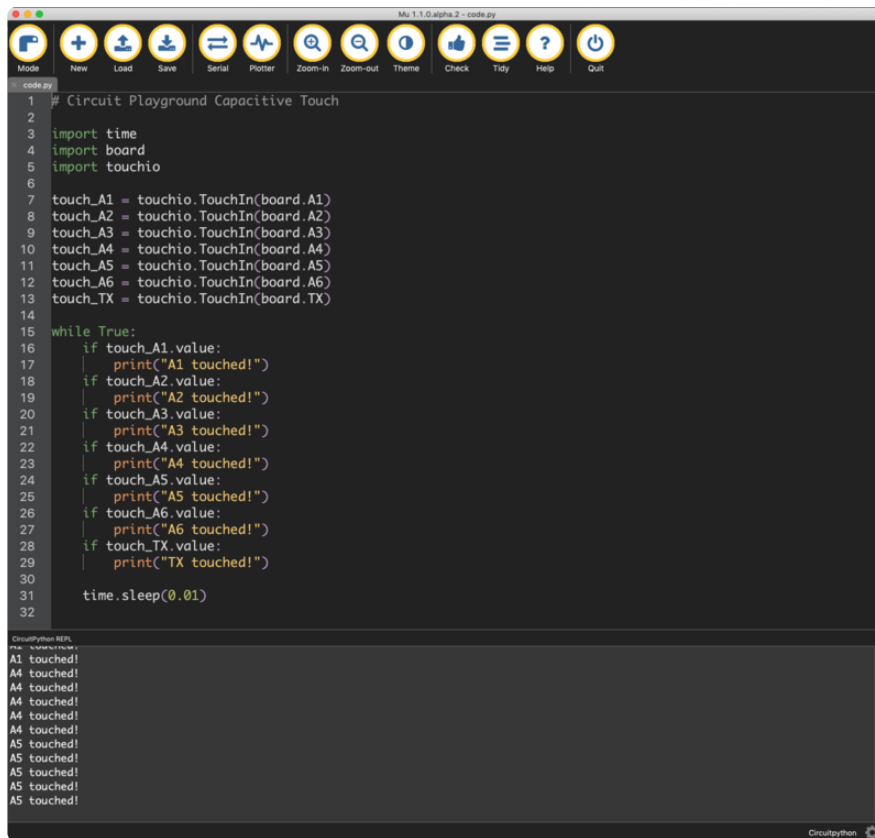

```
1 # Circuit Playground Capacitive Touch
2
3 import time
4 import board
5 import touchio
6
7 touch_A1 = touchio.TouchIn(board.A1)
8 touch_A2 = touchio.TouchIn(board.A2)
9 touch_A3 = touchio.TouchIn(board.A3)
10 touch_A4 = touchio.TouchIn(board.A4)
11 touch_A5 = touchio.TouchIn(board.A5)
12 touch_A6 = touchio.TouchIn(board.A6)
13 touch_TX = touchio.TouchIn(board.TX)
14
15 while True:
16     if touch_A1.value:
17         print("A1 touched!")
18     if touch_A2.value:
19         print("A2 touched!")
20     if touch_A3.value:
21         print("A3 touched!")
22     if touch_A4.value:
23         print("A4 touched!")
24     if touch_A5.value:
25         print("A5 touched!")
26     if touch_A6.value:
27         print("A6 touched!")
28     if touch_TX.value:
29         print("TX touched!")
30
31     time.sleep(0.01)
32
```

CircuitPython REPL  
A1 touched!  
A4 touched!  
A4 touched!  
A4 touched!  
A4 touched!  
A4 touched!  
A5 touched!  
A5 touched!  
A5 touched!  
A5 touched!

Note that no extra hardware is required, you can touch the pads directly, but you may want to attach alligator clips or foil tape to metallic or conductive objects. Try silverware, fruit or other food, liquid, aluminum foil, and items around your desk!

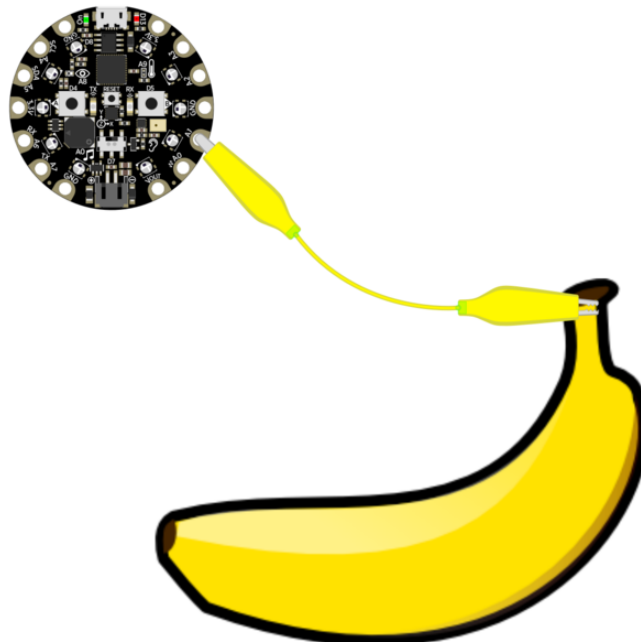

You may need to restart your code/board after changing the attached item because the capacitive touch code 'calibrates' based on what it sees when it first starts up. So if you get too many touch-signals or not enough, hit that reset button!

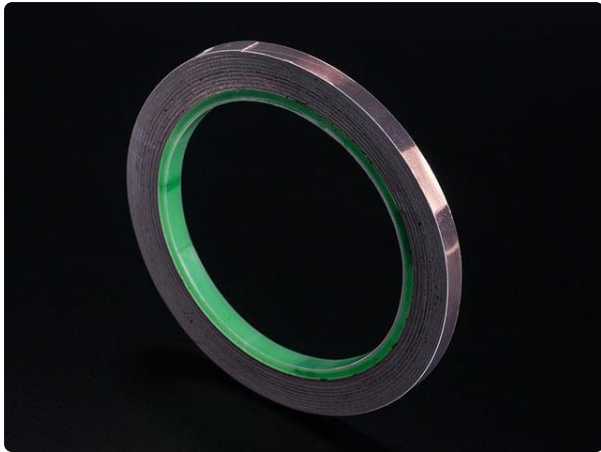

#### Copper Foil Tape with Conductive Adhesive - 6mm x 15 meter roll

Copper tape can be an interesting addition to your toolbox. The tape itself is made of thin pure copper so its extremely flexible and can take on nearly any shape. You can easily...

<https://www.adafruit.com/product/1128>



#### Copper Foil Tape with Conductive Adhesive - 25mm x 15 meter roll

Copper tape can be an interesting addition to your toolbox. The tape itself is made of thin pure copper so its extremely flexible and can take on nearly any shape. You can easily...

<https://www.adafruit.com/product/1127>

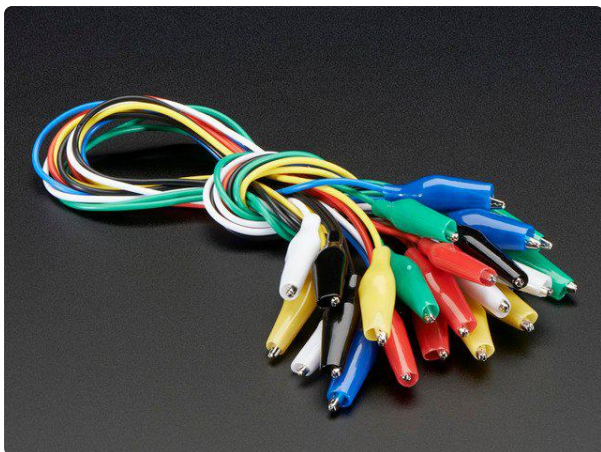

#### Small Alligator Clip Test Lead (set of 12)

Connect this to that without soldering using these handy mini alligator clip test leads. 15" cables with alligator clip on each end, color coded. You get 12 pieces in 6 colors....

<https://www.adafruit.com/product/1008>

## Capacitive Touch and the Audio Pin on Circuit Playground Bluefruit

On the Circuit Playground Bluefruit, if you touch any of the touch pads at the same time as touching the Audio pin, you may hear a clicking or buzzing coming from the speaker. This is due to how the capacitive touch on the Bluefruit works. If you run into this and wish to avoid it, you can turn the speaker off using code by including the following in your code.py:

```
import digitalio

speaker = digitalio.DigitalInOut(board.SPEAKER_ENABLE)
speaker.switch_to_output(value=False)
```

## CircuitPython NeoPixel

Though the following example uses the Circuit Playground Express to demonstrate, the code works exactly the same way with the Circuit Playground Bluefruit. Simply copy the code and follow along with your Circuit Playground Bluefruit!

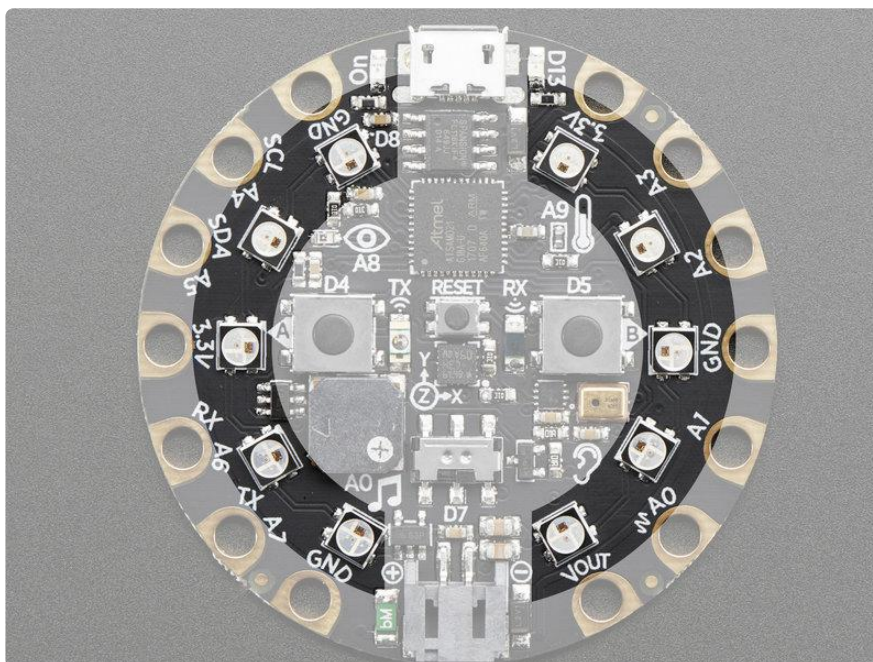

NeoPixels are a revolutionary and ultra-popular way to add lights and color to your project. These stranded RGB lights have the controller inside the LED, so you just push the RGB data and the LEDs do all the work for you! They're a perfect match for CircuitPython.

You can drive 300 pixels with brightness control (e.g. setting `brightness=0.2` to set it to 20% brightness) and 1000 pixels without (e.g. not setting `brightness` at all or setting `brightness=1.0` in object creation). That's because to adjust the brightness we have to dynamically re-create the datastream each write.

Here's an example with a lot of different visual effects you can check out.

In the example below, click the Download Project Bundle button below to download the necessary libraries and the code.py file in a zip file. Extract the contents of the zip

file, open the directory `Introducing_CircuitPlaygroundExpress/`  
`CircuitPlaygroundExpress_NeoPixel/` and then click on the directory that matches the version of CircuitPython you're using and copy the contents of that directory to your CIRCUITPY drive.

Your CIRCUITPY drive should now look similar to the following image:

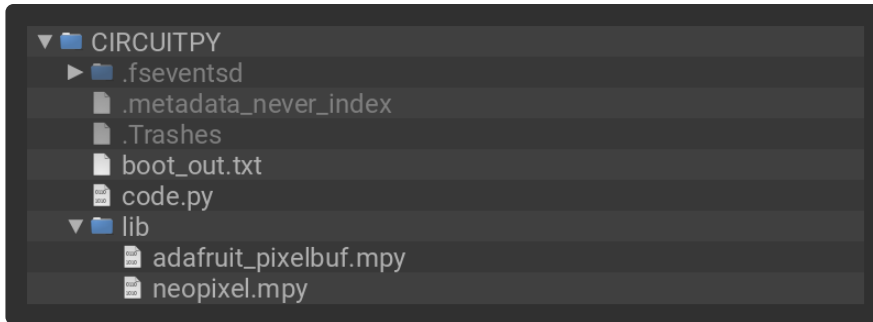

```
# SPDX-FileCopyrightText: 2017 John Edgar Park for Adafruit Industries
#
# SPDX-License-Identifier: MIT

# Circuit Playground NeoPixel
import time
import board
from rainbowio import colorwheel
import neopixel

pixels = neopixel.NeoPixel(board.NEOPIXEL, 10, brightness=0.2, auto_write=False)

# choose which demos to play
# 1 means play, 0 means don't!
color_chase_demo = 1
flash_demo = 1
rainbow_demo = 1
rainbow_cycle_demo = 1

def color_chase(color, wait):
    for i in range(10):
        pixels[i] = color
        time.sleep(wait)
        pixels.show()
    time.sleep(0.5)

def rainbow_cycle(wait):
    for j in range(255):
        for i in range(10):
            rc_index = (i * 256 // 10) + j * 5
            pixels[i] = colorwheel(rc_index & 255)
            pixels.show()
            time.sleep(wait)

def rainbow(wait):
    for j in range(255):
        for i in range(len(pixels)):
            idx = int(i + j)
            pixels[i] = colorwheel(idx & 255)
            pixels.show()
            time.sleep(wait)
```

```

RED = (255, 0, 0)
YELLOW = (255, 150, 0)
GREEN = (0, 255, 0)
CYAN = (0, 255, 255)
BLUE = (0, 0, 255)
PURPLE = (180, 0, 255)
WHITE = (255, 255, 255)
OFF = (0, 0, 0)

while True:
    if color_chase_demo:
        color_chase(RED, 0.1) # Increase the number to slow down the color chase
        color_chase(YELLOW, 0.1)
        color_chase(GREEN, 0.1)
        color_chase(CYAN, 0.1)
        color_chase(BLUE, 0.1)
        color_chase(PURPLE, 0.1)
        color_chase(OFF, 0.1)

    if flash_demo:
        pixels.fill(RED)
        pixels.show()
        # Increase or decrease to change the speed of the solid color change.
        time.sleep(1)
        pixels.fill(GREEN)
        pixels.show()
        time.sleep(1)
        pixels.fill(BLUE)
        pixels.show()
        time.sleep(1)
        pixels.fill(WHITE)
        pixels.show()
        time.sleep(1)

    if rainbow_cycle_demo:
        rainbow_cycle(0.05) # Increase the number to slow down the rainbow.

    if rainbow_demo:
        rainbow(0.05) # Increase the number to slow down the rainbow.

```

The NeoPixel object's argument list requires the pin you'll use (any pin can be used) and the number of pixels. There are two optional arguments, `brightness` (range from 0 off to 1.0 full brightness) and `auto_write`. `auto_write` defaults to `True` when not set. When `auto_write` is set to `True`, every change is immediately written to the strip of pixels, which is easier to use but way slower. If you set `auto_write=False` then you will have to call `pixels.show()` when you want to actually write color data out.

You can easily set colors by indexing into the location `pixels[n] = (red, green, blue)`. For example, `pixels[0] = (100, 0, 0)` will set the first pixel to a medium-brightness red, and `pixels[2] = (0, 255, 0)` will set the third pixel to bright green. Then, if you have `auto_write=False` don't forget to call `pixels.show()`!

You aren't limited to the on-board NeoPixels -- externally connected NeoPixels can be driven by any Digital IO pin.

For powering the pixels from the board, the 3.3V regulator output can handle about 500mA peak which is about 50 pixels with 'average' use. If you want really bright lights and a lot of pixels, we recommend powering direct from the power source. On the Circuit Playground Express this is the Vout pad - that pad has direct power from USB or BAT (battery), depending on which is higher voltage.

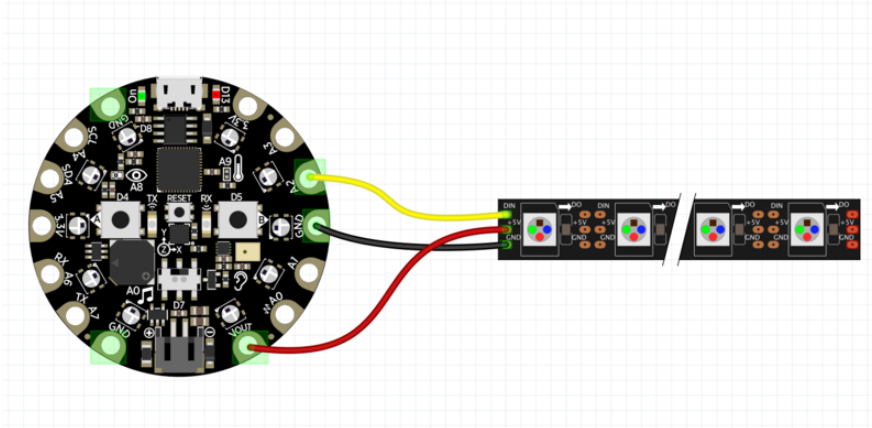

Verify the wiring on your strip or device - plugging into the 'DOUT' side is a common mistake! Wire up NeoPixels only while the Circuit Playground Express is not on, to avoid possible damage!

If the power to the NeoPixels is  $> 5.5V$  you may have some difficulty driving some strips, in which case you may need to lower the voltage to 4.5-5V or use a level shifter

We have a ton more information on general purpose NeoPixel know-how at our NeoPixel UberGuide <https://learn.adafruit.com/adafruit-neopixel-uberguide>

## CircuitPython DotStar

DotStars use two wires, unlike NeoPixel's one wire. They're very similar but you can write to DotStars much faster with hardware SPI and they have a faster PWM cycle so they are better for light painting.

Any pins can be used but if the two pins can form a hardware SPI port, the library will automatically switch over to hardware SPI. If you use hardware SPI then you'll get 4 MHz clock rate (that would mean updating a 64 pixel strand in about 500uS - that's 0.0005 seconds). If you use non-hardware SPI pins you'll drop down to about 3KHz, 1000 times as slow!

You can drive 300 DotStar LEDs with brightness control (set `brightness=1.0` in object creation) and 1000 LEDs without. That's because to adjust the brightness we have to dynamically recreate the data-stream each write.

You'll need the `adafruit_dotstar.mpy` library if you don't already have it in your `/lib` folder! You can get it from the [CircuitPython Library Bundle \(\)](#). If you need help installing the library, check out the [CircuitPython Libraries page \(\)](#).

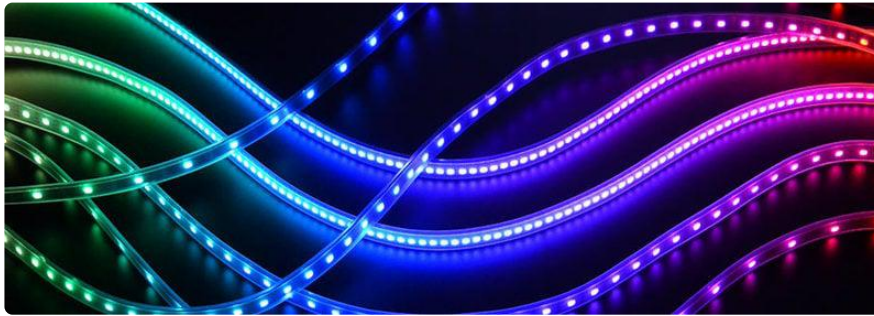

## Wire It Up

You'll need to solder up your DotStars first. Verify your connection is on the DATA INPUT or DI and CLOCK INPUT or CI side. Plugging into the DATA OUT/DO or CLOCK OUT/CO side is a common mistake! The connections are labeled and some formats have arrows to indicate the direction the data must flow. Always verify your wiring with a visual inspection, as the order of the connections can differ from strip to strip!

For powering the pixels from the board, the 3.3V regulator output can handle about 500mA peak which is about 50 pixels with 'average' use. If you want really bright lights and a lot of pixels, we recommend powering direct from an external power source.

- On Gemma M0 and Circuit Playground Express this is the Vout pad - that pad has direct power from USB or the battery, depending on which is higher voltage.
- On Trinket M0, Feather M0 Express, Feather M4 Express, ItsyBitsy M0 Express and ItsyBitsy M4 Express the USB or BAT pins will give you direct power from the USB port or battery.
- On Metro M0 Express and Metro M4 Express, use the 5V pin regardless of whether it's powered via USB or the DC jack.
- On QT Py M0, use the 5V pin.

If the power to the DotStars is greater than 5.5V you may have some difficulty driving some strips, in which case you may need to lower the voltage to 4.5-5V or use a level shifter.

Do not use the VIN pin directly on Metro M0 Express or Metro M4 Express! The voltage can reach 9V and this can destroy your DotStars!

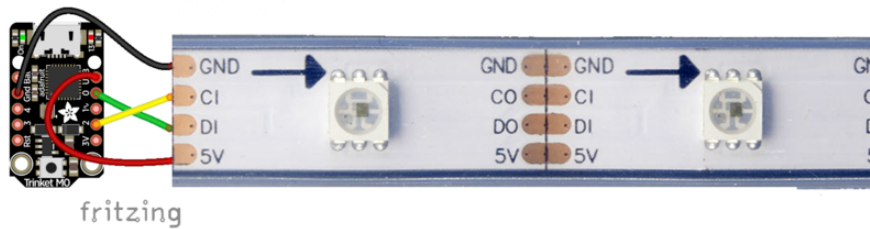

Note that the wire ordering on your DotStar strip or shape may not exactly match the diagram above. Check the markings to verify which pin is DIN, CIN, 5V and GND

## The Code

This example includes multiple visual effects.

To use with CircuitPython, you need to first install a few libraries, into the lib folder on your CIRCUITPY drive. Then you need to update code.py with the example script.

Thankfully, we can do this in one go. In the example below, click the Download Project Bundle button below to download the necessary libraries and the code.py file in a zip file. Extract the contents of the zip file, open the directory CircuitPython\_Essentials/CircuitPython\_DotStar/ and then click on the directory that matches the version of CircuitPython you're using and copy the contents of that directory to your CIRCUITPY drive.

Your CIRCUITPY drive should now look similar to the following image:

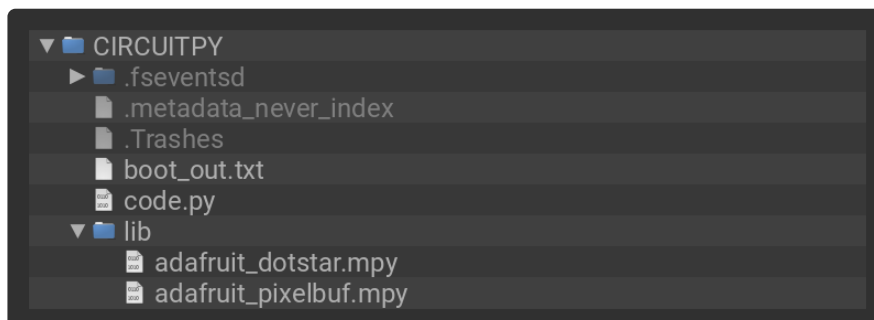

```
# SPDX-FileCopyrightText: 2018 Kattni Rembor for Adafruit Industries  
#
```

```

# SPDX-License-Identifier: MIT

"""CircuitPython Essentials DotStar example"""
import time
from rainbowio import colorwheel
import adafruit_dotstar
import board

num_pixels = 30
pixels = adafruit_dotstar.DotStar(board.A1, board.A2, num_pixels, brightness=0.1,
auto_write=False)

def color_fill(color, wait):
    pixels.fill(color)
    pixels.show()
    time.sleep(wait)

def slice_alternating(wait):
    pixels[::2] = [RED] * (num_pixels // 2)
    pixels.show()
    time.sleep(wait)
    pixels[1::2] = [ORANGE] * (num_pixels // 2)
    pixels.show()
    time.sleep(wait)
    pixels[::2] = [YELLOW] * (num_pixels // 2)
    pixels.show()
    time.sleep(wait)
    pixels[1::2] = [GREEN] * (num_pixels // 2)
    pixels.show()
    time.sleep(wait)
    pixels[::2] = [TEAL] * (num_pixels // 2)
    pixels.show()
    time.sleep(wait)
    pixels[1::2] = [CYAN] * (num_pixels // 2)
    pixels.show()
    time.sleep(wait)
    pixels[::2] = [BLUE] * (num_pixels // 2)
    pixels.show()
    time.sleep(wait)
    pixels[1::2] = [PURPLE] * (num_pixels // 2)
    pixels.show()
    time.sleep(wait)
    pixels[::2] = [MAGENTA] * (num_pixels // 2)
    pixels.show()
    time.sleep(wait)
    pixels[1::2] = [WHITE] * (num_pixels // 2)
    pixels.show()
    time.sleep(wait)

def slice_rainbow(wait):
    pixels[::6] = [RED] * (num_pixels // 6)
    pixels.show()
    time.sleep(wait)
    pixels[1::6] = [ORANGE] * (num_pixels // 6)
    pixels.show()
    time.sleep(wait)
    pixels[2::6] = [YELLOW] * (num_pixels // 6)
    pixels.show()
    time.sleep(wait)
    pixels[3::6] = [GREEN] * (num_pixels // 6)
    pixels.show()
    time.sleep(wait)
    pixels[4::6] = [BLUE] * (num_pixels // 6)
    pixels.show()
    time.sleep(wait)
    pixels[5::6] = [PURPLE] * (num_pixels // 6)

```

```

pixels.show()
time.sleep(wait)

def rainbow_cycle(wait):
    for j in range(255):
        for i in range(num_pixels):
            rc_index = (i * 256 // num_pixels) + j
            pixels[i] = colorwheel(rc_index & 255)
        pixels.show()
        time.sleep(wait)

RED = (255, 0, 0)
YELLOW = (255, 150, 0)
ORANGE = (255, 40, 0)
GREEN = (0, 255, 0)
TEAL = (0, 255, 120)
CYAN = (0, 255, 255)
BLUE = (0, 0, 255)
PURPLE = (180, 0, 255)
MAGENTA = (255, 0, 20)
WHITE = (255, 255, 255)

while True:
    # Change this number to change how long it stays on each solid color.
    color_fill(RED, 0.5)
    color_fill(YELLOW, 0.5)
    color_fill(ORANGE, 0.5)
    color_fill(GREEN, 0.5)
    color_fill(TEAL, 0.5)
    color_fill(CYAN, 0.5)
    color_fill(BLUE, 0.5)
    color_fill(PURPLE, 0.5)
    color_fill(MAGENTA, 0.5)
    color_fill(WHITE, 0.5)

    # Increase or decrease this to speed up or slow down the animation.
    slice_alternating(0.1)

    color_fill(WHITE, 0.5)

    # Increase or decrease this to speed up or slow down the animation.
    slice_rainbow(0.1)

    time.sleep(0.5)

    # Increase this number to slow down the rainbow animation.
    rainbow_cycle(0)

```

We've chosen pins A1 and A2, but these are not SPI pins on all boards. DotStars respond faster when using hardware SPI!

## Create the LED

The first thing we'll do is create the LED object. The DotStar object has three required arguments and two optional arguments. You are required to set the pin you're using for data, set the pin you'll be using for clock, and provide the number of pixels you intend to use. You can optionally set `brightness` and `auto_write`.

DotStars can be driven by any two pins. We've chosen A1 for clock and A2 for data. To set the pins, include the pin names at the beginning of the object creation, in this case `board.A1` and `board.A2`.

To provide the number of pixels, assign the variable `num_pixels` to the number of pixels you'd like to use. In this example, we're using a strip of `72`.

We've chosen to set `brightness=0.1`, or 10%.

By default, `auto_write=True`, meaning any changes you make to your pixels will be sent automatically. Since `True` is the default, if you use that setting, you don't need to include it in your LED object at all. We've chosen to set `auto_write=False`. If you set `auto_write=False`, you must include `pixels.show()` each time you'd like to send data to your pixels. This makes your code more complicated, but it can make your LED animations faster!

## DotStar Helpers

We've included a few helper functions to create the super fun visual effects found in this code.

First is `wheel()` which we just learned with the [Internal RGB LED \(\)](#). Then we have `color_fill()` which requires you to provide a `color` and the length of time you'd like it to be displayed. Next, are `slice_alternating()`, `slice_rainbow()`, and `rainbow_cycle()` which require you to provide the amount of time in seconds you'd between each step of the animation.

Last, we've included a list of variables for our colors. This makes it much easier if to reuse the colors anywhere in the code, as well as add more colors for use in multiple places. Assigning and using RGB colors is explained in [this section of the CircuitPython Internal RGB LED page \(\)](#).

The two slice helpers utilise a nifty feature of the DotStar library that allows us to use math to light up LEDs in repeating patterns. `slice_alternating()` first lights up the even number LEDs and then the odd number LEDs and repeats this back and forth. `slice_rainbow()` lights up every sixth LED with one of the six rainbow colors until the strip is filled. Both use our handy color variables. This slice code only works when the total number of LEDs is divisible by the slice size, in our case 2 and 6. DotStars come in strips of 30, 60, 72, and 144, all of which are divisible by 2 and 6. In the event that you cut them into different sized strips, the code in this example may not work without

modification. However, as long as you provide a total number of LEDs that is divisible by the slices, the code will work.

## Main Loop

Our main loop begins by calling `color_fill()` once for each `color` on our list and sets each to hold for `0.5` seconds. You can change this number to change how fast each color is displayed. Next, we call `slice_alternating(0.1)`, which means there's a 0.1 second delay between each change in the animation. Then, we fill the strip white to create a clean backdrop for the rainbow to display. Then, we call `slice_rainbow(0.1)`, for a 0.1 second delay in the animation. Last we call `rainbow_cycle(0)`, which means it's as fast as it can possibly be. Increase or decrease either of these numbers to speed up or slow down the animations!

Note that the longer your strip of LEDs is, the longer it will take for the animations to complete.

We have a ton more information on general purpose DotStar know-how at our DotStar UberGuide <https://learn.adafruit.com/adafruit-dotstar-leds>

## Is it SPI?

We explained at the beginning of this section that the LEDs respond faster if you're using hardware SPI. On some of the boards, there are HW SPI pins directly available in the form of MOSI and SCK. However, hardware SPI is available on more than just those pins. But, how can you figure out which? Easy! We wrote a handy script.

We chose pins A1 and A2 for our example code. To see if these are hardware SPI on the board you're using, copy and paste the code into `code.py` using your favorite editor, and save the file. Then connect to the serial console to see the results.

To check if other pin combinations have hardware SPI, change the pin names on the line reading: `if is_hardware_SPI(board.A1, board.A2):` to the pins you want to use. Then, check the results in the serial console. Super simple!

In the example below, click the Download Project Bundle button below to download the necessary libraries and the `code.py` file in a zip file. Extract the contents of the zip file, open the directory `CircuitPython_Essentials/SPI_Test_Script/` and then click on the directory that matches the version of CircuitPython you're using and copy the contents of that directory to your CIRCUITPY drive.

Your CIRCUITPY drive should now look similar to the following image:

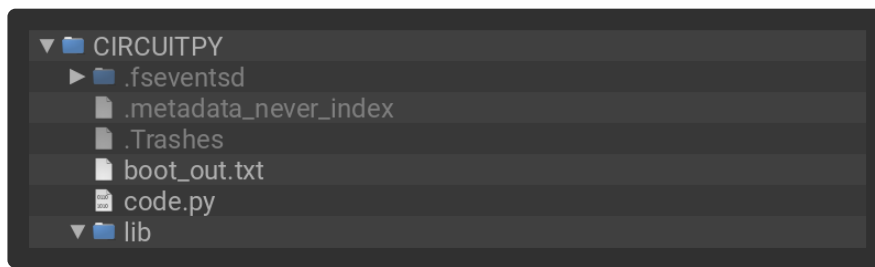

```
# SPDX-FileCopyrightText: 2018 Kattni Rembor for Adafruit Industries
#
# SPDX-License-Identifier: MIT

"""CircuitPython Essentials Hardware SPI pin verification script"""
import board
import busio

def is_hardware_spi(clock_pin, data_pin):
    try:
        p = busio.SPI(clock_pin, data_pin)
        p.deinit()
        return True
    except ValueError:
        return False

# Provide the two pins you intend to use.
if is_hardware_spi(board.A1, board.A2):
    print("This pin combination is hardware SPI!")
else:
    print("This pin combination isn't hardware SPI.")
```

## Read the Docs

For a more in depth look at what [dotstar](#) can do, check out [DotStar on Read the Docs \(\)](#).

---

## CircuitPython UART Serial

In addition to the USB-serial connection you use for the REPL, there is also a hardware UART you can use. This is handy to talk to UART devices like GPSs, some sensors, or other microcontrollers!

This quick-start example shows how you can create a UART device for communicating with hardware serial devices.

To use this example, you'll need something to generate the UART data. We've used a GPS! Note that the GPS will give you UART data without getting a fix on your location.

You can use this example right from your desk! You'll have data to read, it simply won't include your actual location.

The QT Py M0 does not have a little red LED. Therefore, you must connect an external LED and edit this example for it to work. Follow the wiring diagram and steps below to run this example on QT Py M0.

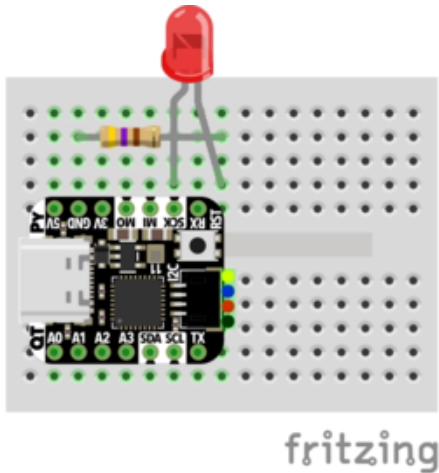

LED + to QT Py SCK  
LED - to 470Ω resistor  
470Ω resistor to QT Py GND

In the example below, click the Download Project Bundle button below to download the necessary libraries and the code.py file in a zip file. Extract the contents of the zip file, open the directory CircuitPython\_Essentials/CircuitPython\_UART/ and then click on the directory that matches the version of CircuitPython you're using and copy the contents of that directory to your CIRCUITPY drive.

Your CIRCUITPY drive should now look similar to the following image:

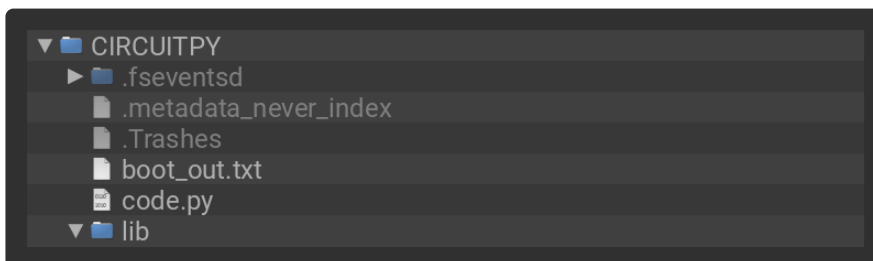

```
# SPDX-FileCopyrightText: 2018 Kattni Rembor for Adafruit Industries
#
# SPDX-License-Identifier: MIT

"""CircuitPython Essentials UART Serial example"""
import board
import busio
import digitalio

# For most CircuitPython boards:
led = digitalio.DigitalInOut(board.LED)
# For QT Py M0:
led = digitalio.DigitalInOut(board.SCK)
led.direction = digitalio.Direction.OUTPUT
```

```

uart = busio.UART(board.TX, board.RX, baudrate=9600)

while True:
    data = uart.read(32) # read up to 32 bytes
    # print(data) # this is a bytearray type

    if data is not None:
        led.value = True

        # convert bytearray to string
        data_string = ''.join([chr(b) for b in data])
        print(data_string, end="")

        led.value = False

```

Note: To "comment out" a line, put a # and a space before it. To "uncomment" a line, remove the # + space from the beginning of the line.

For QT Py M0, you'll need to comment out `led = DigitalInOut(board.LED)` and uncomment `led = DigitalInOut(board.SCK)`. The UART code remains the same.

## The Code

First we create the UART object. We provide the pins we'd like to use, `board.TX` and `board.RX`, and we set the `baudrate=9600`. While these pins are labeled on most of the boards, be aware that RX and TX are not labeled on Gemma, and are labeled on the bottom of Trinket. See the diagrams below for help with finding the correct pins on your board.

Once the object is created you read data in with `read(numbytes)` where you can specify the max number of bytes. It will return a byte array type object if anything was received already. Note it will always return immediately because there is an internal buffer! So read as much data as you can 'digest'.

If there is no data available, `read()` will return `None`, so check for that before continuing.

The data that is returned is in a byte array, if you want to convert it to a string, you can use this handy line of code which will run `chr()` on each byte:

```

datastr = ''.join([chr(b) for b in data]) # convert bytearray to string

```

Your results will look something like this:



Watch out! A common mixup with UART serial is that RX on one board connects to TX on the other! However, sometimes boards have RX labeled TX and vice versa. So, you'll want to start with RX connected to TX, but if that doesn't work, try the other way around!

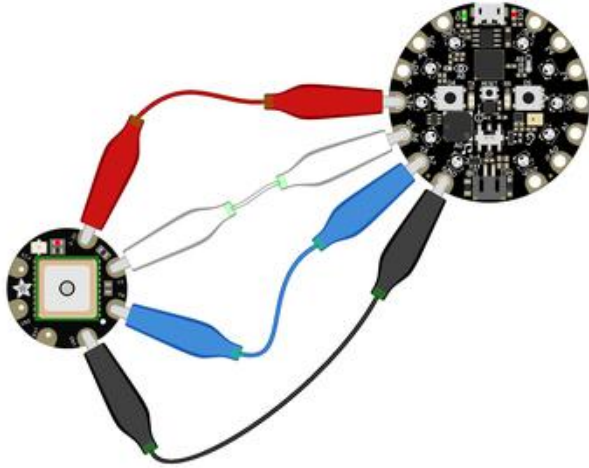

#### Circuit Playground Express and Circuit Playground Bluefruit

- Connect 3.3v on your CPX to 3.3v on your GPS.
- Connect GND on your CPX to GND on your GPS.
- Connect RX/A6 on your CPX to TX on your GPS.
- Connect TX/A7 on your CPX to RX on your GPS.

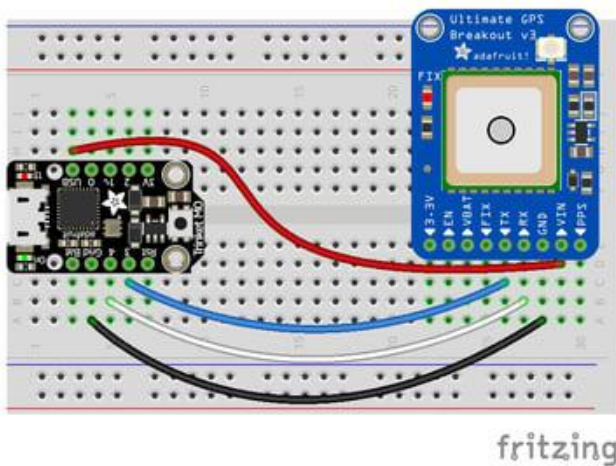

#### Trinket M0

- Connect USB on the Trinket to VIN on the GPS.
- Connect Gnd on the Trinket to GND on the GPS.
- Connect D3 on the Trinket to TX on the GPS.
- Connect D4 on the Trinket to RX on the GPS.

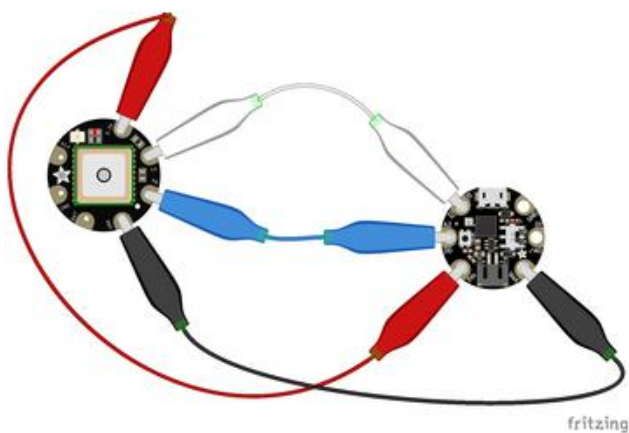

#### Gemma M0

- Connect 3vo on the Gemma to 3.3v on the GPS.
- Connect GND on the Gemma to GND on the GPS.
- Connect A1/D2 on the Gemma to TX on the GPS.
- Connect A2/D0 on the Gemma to RX on the GPS.

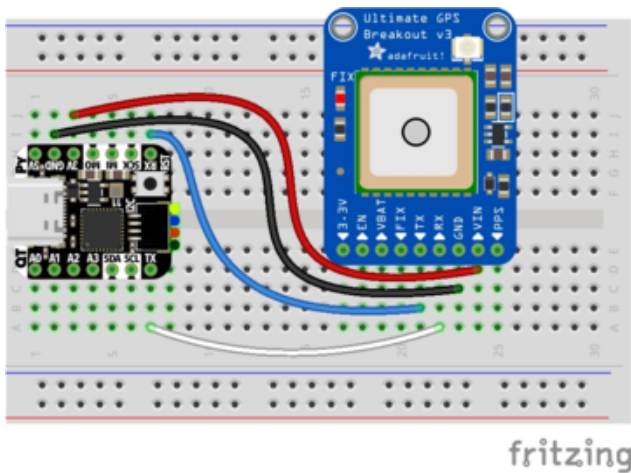

### QT Py M0

- Connect 3V on the QT Py to VIN on the GPS.
- Connect GND on the QT Py to GND on the GPS.
- Connect RX on the QT Py to TX on the GPS.
- Connect TX on the QT Py to RX on the GPS.

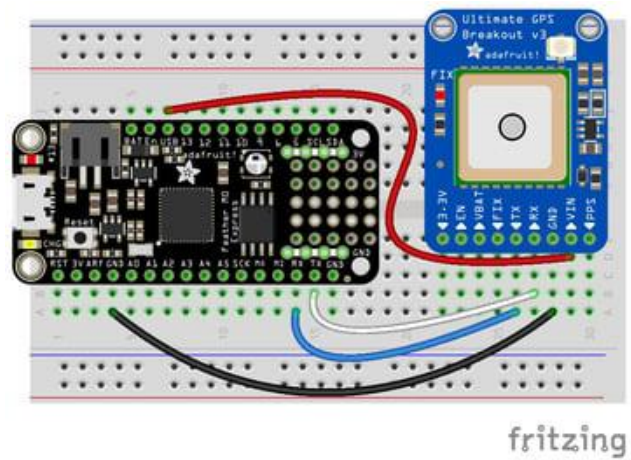

### Feather M0 Express and Feather M4 Express

- Connect USB on the Feather to VIN on the GPS.
- Connect GND on the Feather to GND on the GPS.
- Connect RX on the Feather to TX on the GPS.
- Connect TX on the Feather to RX on the GPS.

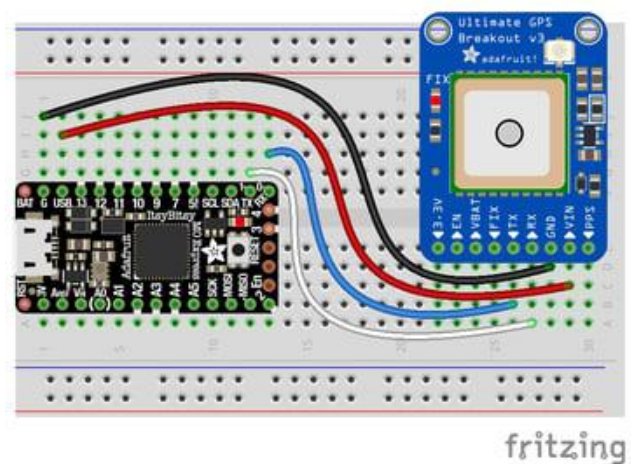

### ItsyBitsy M0 Express and ItsyBitsy M4 Express

- Connect USB on the ItsyBitsy to VIN on the GPS
- Connect G on the ItsyBitsy to GND on the GPS.
- Connect RX/0 on the ItsyBitsy to TX on the GPS.
- Connect TX/1 on the ItsyBitsy to RX on the GPS.

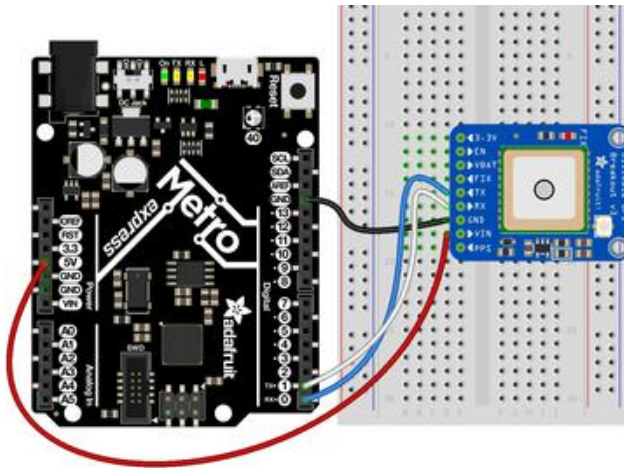

Metro M0 Express and Metro M4 Express

Connect 5V on the Metro to VIN on the GPS.

Connect GND on the Metro to GND on the GPS.

Connect RX/D0 on the Metro to TX on the GPS.

Connect TX/D1 on the Metro to RX on the GPS.

## Where's my UART?

On the SAMD21, we have the flexibility of using a wide range of pins for UART. Compare this to some chips like the ESP8266 with fixed UART pins. The good news is you can use many but not all pins. Given the large number of SAMD boards we have, its impossible to guarantee anything other than the labeled 'TX' and 'RX'. So, if you want some other setup, or multiple UARTs, how will you find those pins? Easy! We've written a handy script.

These are the results from a Trinket M0, your output may vary and it might be very long. [For more details about UARTs and SERCOMs check out our detailed guide here](#)  
()

```
Auto-reload is on. Simply save files over USB to run them or enter REPL to disable.
code.py output:
RX pin: board.D2      TX pin: board.D0
RX pin: board.D4      TX pin: board.D0
RX pin: board.D3      TX pin: board.D0
RX pin: board.D13     TX pin: board.D0
RX pin: board.D0      TX pin: board.D4
RX pin: board.D2      TX pin: board.D4
RX pin: board.D3      TX pin: board.D4
RX pin: board.D0      TX pin: board.D13
RX pin: board.D2      TX pin: board.D13
RX pin: board.D3      TX pin: board.D13
```

In the example below, click the Download Project Bundle button below to download the necessary libraries and the code.py file in a zip file. Extract the contents of the zip file, open the directory CircuitPython\_Essentials/UART\_Test\_Script/ and then click on the directory that matches the version of CircuitPython you're using and copy the contents of that directory to your CIRCUITPY drive.

Your CIRCUITPY drive should now look similar to the following image:

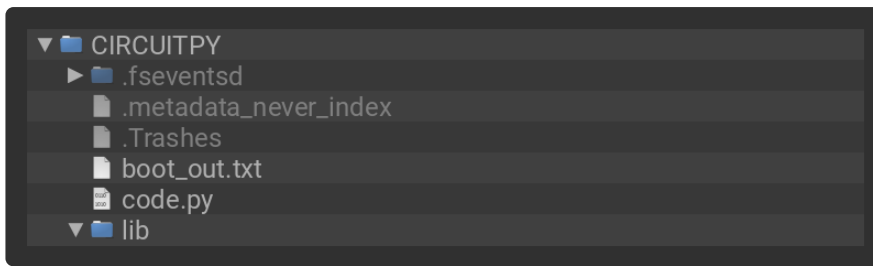

```
# SPDX-FileCopyrightText: 2018 Kattni Rembor for Adafruit Industries
#
# SPDX-License-Identifier: MIT

"""CircuitPython Essentials UART possible pin-pair identifying script"""
import board
import busio
from microcontroller import Pin

def is_hardware_uart(tx, rx):
    try:
        p = busio.UART(tx, rx)
        p.deinit()
        return True
    except ValueError:
        return False

def get_unique_pins():
    exclude = ['NEOPIXEL', 'APA102_MOSI', 'APA102_SCK']
    pins = [pin for pin in [
        getattr(board, p) for p in dir(board) if p not in exclude]
        if isinstance(pin, Pin)]
    unique = []
    for p in pins:
        if p not in unique:
            unique.append(p)
    return unique

for tx_pin in get_unique_pins():
    for rx_pin in get_unique_pins():
        if rx_pin is tx_pin:
            continue
        if is_hardware_uart(tx_pin, rx_pin):
            print("RX pin:", rx_pin, "\t TX pin:", tx_pin)
```

## Trinket M0: Create UART before I2C

On the Trinket M0 (only), if you are using both UART and I2C, you must create the UART object first, e.g.:

```
>>> import board
>>> uart = board.UART() # Uses pins 4 and 3 for TX and RX, baudrate 9600.
>>> i2c = board.I2C() # Uses pins 2 and 0 for SCL and SDA.

# or alternatively,
```

Creating the I2C object first does not work:

```
>>> import board
>>> i2c = board.I2C() # Uses pins 2 and 0 for SCL and SDA.
>>> uart = board.UART() # Uses pins 4 and 3 for TX and RX, baudrate 9600.
Traceback (most recent call last):
  File "", line 1, in
ValueError: Invalid pins
```

---

## CircuitPython I2C

I2C is a 2-wire protocol for communicating with simple sensors and devices, meaning it uses two connections for transmitting and receiving data. There are many I2C devices available and they're really easy to use with CircuitPython. We have libraries available for many I2C devices in the [library bundle \(\)](#). (If you don't see the sensor you're looking for, keep checking back, more are being written all the time!)

In this section, we're going to do is learn how to scan the I2C bus for all connected devices. Then we're going to learn how to interact with an I2C device.

We'll be using the [Adafruit TSL2591 \(\)](#), a common, low-cost light sensor. While the exact code we're running is specific to the TSL2591 the overall process is the same for just about any I2C sensor or device.

These examples will use the TSL2591 lux sensor breakout. The first thing you'll want to do is get the sensor connected so your board has I2C to talk to.

### Wire It Up

You'll need a couple of things to connect the TSL2591 to your board. The TSL2591 comes with STEMMA QT / QWIIC connectors on it, which makes it super simple to wire it up. No further soldering required!

For Gemma M0, Circuit Playground Express and Circuit Playground Bluefruit, you can use use the [STEMMA QT to alligator clips cable \(\)](#) to connect to the TSL2591.

For Trinket M0, Feather M0 and M4 Express, Metro M0 and M4 Express and ItsyBitsy M0 and M4 Express, you'll need a breadboard and [STEMMA QT to male jumper wires cable \(\)](#) to connect to the TSL2591.

For QT Py M0, you'll need a [STEMMA QT cable \(\)](#) to connect to the TSL2591.

We've included diagrams show you how to connect the TSL2591 to your board. In these diagrams, the wire colors match the STEMMA QT cables and connect to the same pins on each board.

- The black wire connects from GND on the TSL2591 to ground on your board.
- The red wire connects from VIN on the TSL2591 to power on your board.
- The yellow wire connects from SCL on the TSL2591 to SCL on your board.
- The blue wire connects from SDA on the TSL2591 to SDA on your board.

Check out the list below for a diagram of your specific board!

Be aware that the Adafruit microcontroller boards do not have I2C pullup resistors built in! All of the Adafruit breakouts do, but if you're building your own board or using a non-Adafruit breakout, you must add 2.2K-10K ohm pullups on both SDA and SCL to the 3.3V.

#### Circuit Playground Express and Circuit Playground Bluefruit

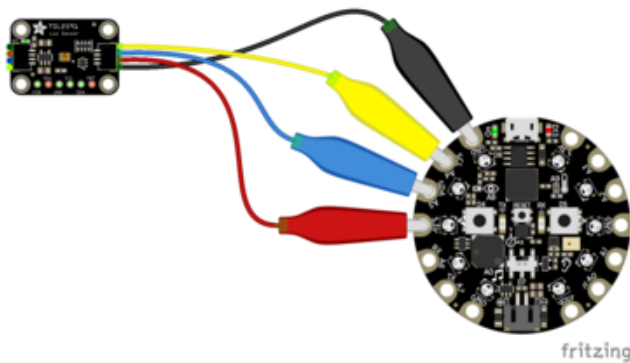

Connect 3.3v on your CPX to 3.3v on your TSL2591.

Connect GND on your CPX to GND on your TSL2591.

Connect SCL/A4 on your CPX to SCL on your TSL2591.

Connect SDL/A5 on your CPX to SDA on your TSL2591.

#### Trinket M0

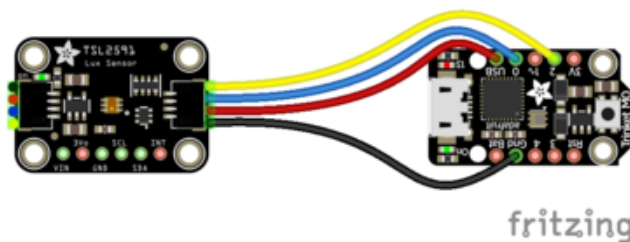

Connect USB on the Trinket to VIN on the TSL2591.

Connect Gnd on the Trinket to GND on the TSL2591.

Connect D2 on the Trinket to SCL on the TSL2591.

Connect D0 on the Trinket to SDA on the TSL2591.

## Gemma M0

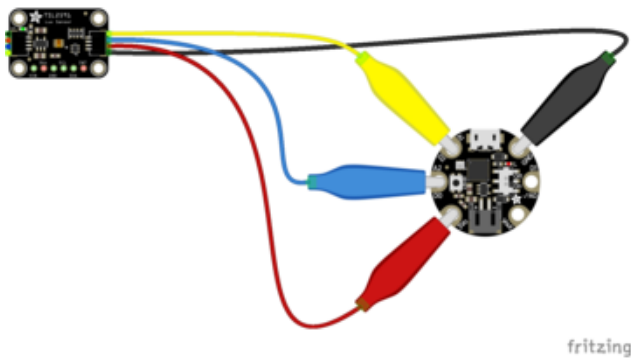

Connect 3V on the Gemma to 3V on the TSL2591.

Connect GND on the Gemma to GND on the TSL2591.

Connect A1/D2 on the Gemma to SCL on the TSL2591.

Connect A2/D0 on the Gemma to SDA on the TSL2591.

## QT Py M0

If using the STEMMA QT cable:

Connect the STEMMA QT cable from the connector on the QT Py to the connector on the TSL2591.

Alternatively, if using a breadboard:

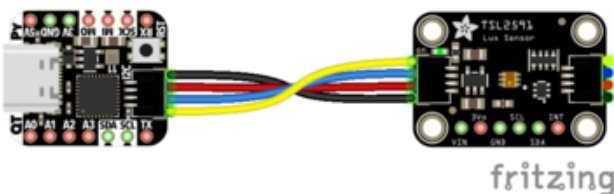

Connect 3V on the QT Py to VIN on the TSL2591.

Connect GND on the QT Py to GND on the TSL2591.

Connect SCL on the QT Py to SCL on the TSL2591.

Connect SDA on the QT Py to SDA on the TSL2591.

## Feather M0 Express and Feather M4 Express

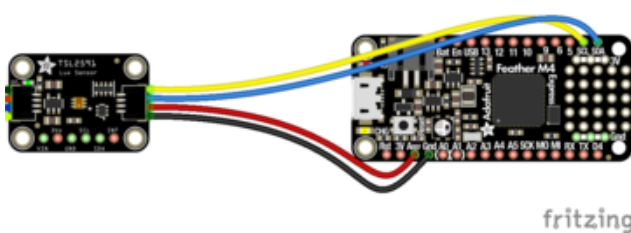

Connect USB on the Feather to VIN on the TSL2591.

Connect GND on the Feather to GND on the TSL2591.

Connect SCL on the Feather to SCL on the TSL2591.

Connect SDA on the Feather to SDA on the TSL2591.

ItsyBitsy M0 Express and ItsyBitsy M4 Express

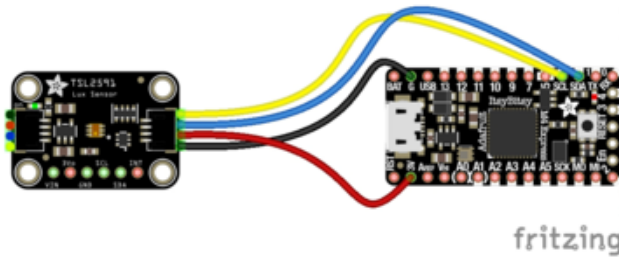

Connect USB on the ItsyBitsy to VIN on the TSL2591  
Connect G on the ItsyBitsy to GND on the TSL2591.  
Connect SCL on the ItsyBitsy to SCL on the TSL2591.  
Connect SDA on the ItsyBitsy to SDA on the TSL2591.

Metro M0 Express and Metro M4 Express

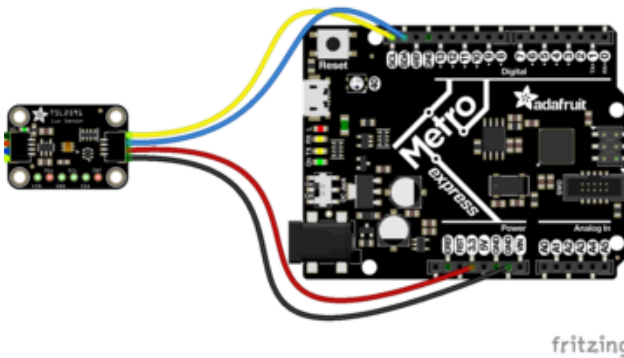

Connect 5V on the Metro to VIN on the TSL2591.  
Connect GND on the Metro to GND on the TSL2591.  
Connect SCL on the Metro to SCL on the TSL2591.  
Connect SDA on the Metro to SDA on the TSL2591.

## Find Your Sensor

The first thing you'll want to do after getting the sensor wired up, is make sure it's wired correctly. We're going to do an I2C scan to see if the board is detected, and if it is, print out its I2C address.

In the example below, click the Download Project Bundle button below to download the necessary libraries and the code.py file in a zip file. Extract the contents of the zip file, open the directory `CircuitPython_Essentials/CircuitPython_I2C_Scan/` and then click on the directory that matches the version of CircuitPython you're using and copy the contents of that directory to your CIRCUITPY drive.

Your CIRCUITPY drive should now look similar to the following image:

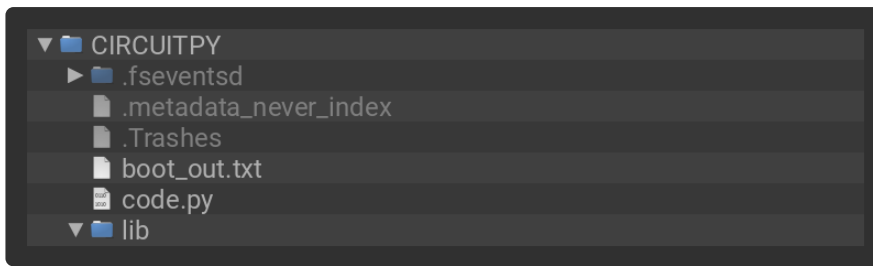

```
# SPDX-FileCopyrightText: 2017 Limor Fried for Adafruit Industries
#
# SPDX-License-Identifier: MIT

"""CircuitPython I2C Device Address Scan"""
# If you run this and it seems to hang, try manually unlocking
# your I2C bus from the REPL with
# >>> import board
# >>> board.I2C().unlock()

import time
import board

# To use default I2C bus (most boards)
i2c = board.I2C() # uses board.SCL and board.SDA
# i2c = board.STEMMA_I2C() # For using the built-in STEMMA QT connector on a
# microcontroller

# To create I2C bus on specific pins
# import busio
# i2c = busio.I2C(board.SCL1, board.SDA1) # QT Py RP2040 STEMMA connector
# i2c = busio.I2C(board.GP1, board.GP0) # Pi Pico RP2040

while not i2c.try_lock():
    pass

try:
    while True:
        print(
            "I2C addresses found:",
            [hex(device_address) for device_address in i2c.scan()],
        )
        time.sleep(2)

finally: # unlock the i2c bus when ctrl-c'ing out of the loop
    i2c.unlock()
```

First we create the `i2c` object, using `board.I2C()`. This convenience routine creates and saves a `busio.I2C` object using the default pins `board.SCL` and `board.SDA`. If the object has already been created, then the existing object is returned. No matter how many times you call `board.I2C()`, it will return the same object. This is called a singleton.

To be able to scan it, we need to lock the I2C down so the only thing accessing it is the code. So next we include a loop that waits until I2C is locked and then continues on to the scan function.

Last, we have the loop that runs the actual scan, `i2c_scan()`. Because I2C typically refers to addresses in hex form, we've included this bit of code that formats the

results into hex format: `[hex(device_address) for device_address in i2c.scan()]`.

Open the serial console to see the results! The code prints out an array of addresses. We've connected the TSL2591 which has a 7-bit I2C address of 0x29. The result for this sensor is `I2C addresses found: ['0x29']`. If no addresses are returned, refer back to the wiring diagrams to make sure you've wired up your sensor correctly.

## I2C Sensor Data

Now we know for certain that our sensor is connected and ready to go. Let's find out how to get the data from our sensor!

## Installing Project Code

To use with CircuitPython, you need to first install a few libraries, into the lib folder on your CIRCUITPY drive. Then you need to update code.py with the example script.

Thankfully, we can do this in one go. In the example below, click the Download Project Bundle button below to download the necessary libraries and the code.py file in a zip file. Extract the contents of the zip file, open the directory CircuitPython\_Essentials/CircuitPython\_I2C\_TSL2591/ and then click on the directory that matches the version of CircuitPython you're using and copy the contents of that directory to your CIRCUITPY drive.

Your CIRCUITPY drive should now look similar to the following image:

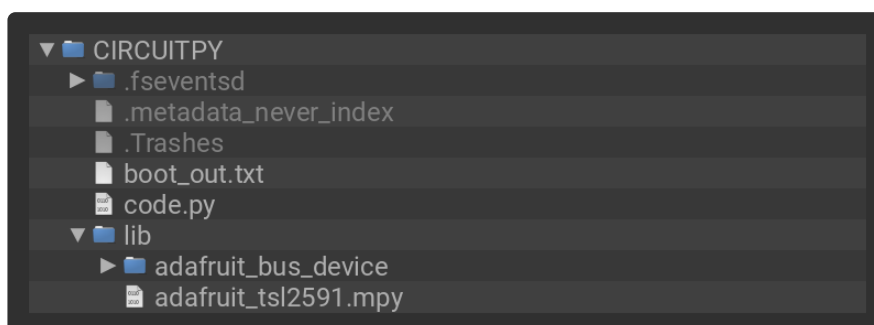

```
# SPDX-FileCopyrightText: 2017 Limor Fried for Adafruit Industries
#
# SPDX-License-Identifier: MIT

"""CircuitPython Essentials I2C sensor example using TSL2591"""
import time
import board
import adafruit_tsl2591

i2c = board.I2C() # uses board.SCL and board.SDA
```

```

# i2c = board.STEMMA_I2C() # For using the built-in STEMMMA QT connector on a
microcontroller

# Lock the I2C device before we try to scan
while not i2c.try_lock():
    pass
# Print the addresses found once
print("I2C addresses found:", [hex(device_address) for device_address in
i2c.scan()])

# Unlock I2C now that we're done scanning.
i2c.unlock()

# Create library object on our I2C port
tsl2591 = adafruit_tsl2591.TSL2591(i2c)

# Use the object to print the sensor readings
while True:
    print("Lux:", tsl2591.lux)
    time.sleep(0.5)

```

This code begins the same way as the scan code. We've included the scan code so you have verification that your sensor is wired up correctly and is detected. It prints the address once. After the scan, we unlock I2C with `i2c.unlock()` so we can use the sensor for data.

We create our sensor object using the sensor library. We call it `tsl2591` and provide it the `i2c` object.

Then we have a simple loop that prints out the lux reading using the sensor object we created. We add a `time.sleep(1.0)`, so it only prints once per second. Connect to the serial console to see the results. Try shining a light on it to see the results change!

The screenshot shows the Mu Python IDE interface. The top toolbar includes icons for Mode, New, Load, Save, Serial, Plotter, Zoom-in, Zoom-out, Theme, Check, Help, and Quit. The code editor displays the Python code from the previous block. Below the editor is the Adafruit CircuitPython REPL, which shows the output of the code execution:

```

I2C addresses found: ['0x29']
Lux: 36.3871
Lux: 36.8767
Lux: 36.8179
Lux: 36.596
Lux: 36.4915
Lux: 36.3283
Lux: 36.4328
Lux: 36.2696
Lux: 36.5503
Lux: 36.7135
Lux: 36.7592
Lux: 36.1864
Lux: 36.2239

```

## Where's my I2C?

On the SAMD21, SAMD51 and nRF52840, we have the flexibility of using a wide range of pins for I2C. On the nRF52840, any pin can be used for I2C! Some chips, like the ESP8266, require using bitbangio, but can also use any pins for I2C. There's some other chips that may have fixed I2C pin.

The good news is you can use many but not all pins. Given the large number of SAMD boards we have, its impossible to guarantee anything other than the labeled 'SDA' and 'SCL'. So, if you want some other setup, or multiple I2C interfaces, how will you find those pins? Easy! We've written a handy script.

These are the results from an ItsyBitsy M0 Express. Your output may vary and it might be very long. For more details about I2C and SERCOMs, [check out our detailed guide here \(\)](#).

```
Auto-reload is on. Simply save files over USB to run them or enter REPL to disable.
code.py output:
SCL pin: board.D3      SDA pin: board.D4
SCL pin: board.D3      SDA pin: board.A3
SCL pin: board.D3      SDA pin: board.MISO
SCL pin: board.D13     SDA pin: board.D11
SCL pin: board.D13     SDA pin: board.SDA
SCL pin: board.A2      SDA pin: board.A1
SCL pin: board.A2      SDA pin: board.MISO
SCL pin: board.A4      SDA pin: board.D4
SCL pin: board.A4      SDA pin: board.A3
SCL pin: board.SCL     SDA pin: board.D11
SCL pin: board.SCL     SDA pin: board.SDA

Press any key to enter the REPL. Use CTRL-D to reload.
```

In the example below, click the Download Project Bundle button below to download the necessary libraries and the code.py file in a zip file. Extract the contents of the zip file, open the directory CircuitPython\_Essentials/I2C\_Test\_Script/ and then click on the directory that matches the version of CircuitPython you're using and copy the contents of that directory to your CIRCUITPY drive.

Your CIRCUITPY drive should now look similar to the following image:

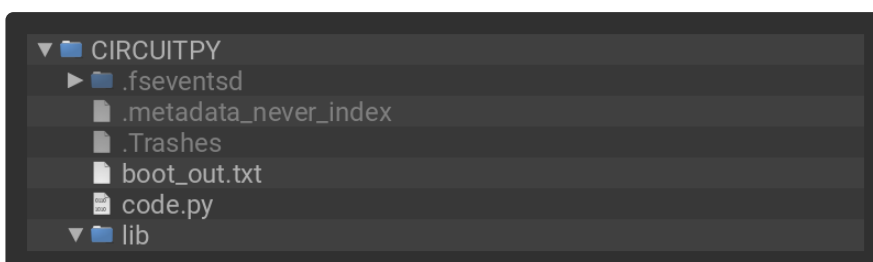

```

# SPDX-FileCopyrightText: 2018 Kattni Rembor for Adafruit Industries
#
# SPDX-License-Identifier: MIT

"""CircuitPython Essentials I2C possible pin-pair identifying script"""
import board
import busio
from microcontroller import Pin

def is_hardware_I2C(scl, sda):
    try:
        p = busio.I2C(scl, sda)
        p.deinit()
        return True
    except ValueError:
        return False
    except RuntimeError:
        return True

def get_unique_pins():
    exclude = ['NEOPIXEL', 'APA102_MOSI', 'APA102_SCK']
    pins = [pin for pin in [
        getattr(board, p) for p in dir(board) if p not in exclude]
        if isinstance(pin, Pin)]
    unique = []
    for p in pins:
        if p not in unique:
            unique.append(p)
    return unique

for scl_pin in get_unique_pins():
    for sda_pin in get_unique_pins():
        if scl_pin is sda_pin:
            continue
        if is_hardware_I2C(scl_pin, sda_pin):
            print("SCL pin:", scl_pin, "\t SDA pin:", sda_pin)

```

## CircuitPython HID Keyboard

Though the following example uses the Circuit Playground Express to demonstrate, the code works exactly the same way with the Circuit Playground Bluefruit. Simply copy the code and follow along with your Circuit Playground Bluefruit!



One of the things we baked into CircuitPython is 'HID' control - Keyboard and Mouse capabilities. This means a Circuit Playground Express can act like a keyboard device and press keys, or a mouse and have it move the mouse around and press buttons. This is really handy because even if you cannot adapt your software to work with hardware, there's almost always a keyboard interface - so if you want to have a capacitive touch interface for a game, say, then keyboard emulation can often get you going really fast!

Then try running this example code which will set the Circuit Playground Express Button\_A and Button\_B as HID keyboard "keys".

In the example below, click the Download Project Bundle button below to download the necessary libraries and the code.py file in a zip file. Extract the contents of the zip file, open the directory `Introducing_CircuitPlaygroundExpress/CircuitPlaygroundExpress_HIDKeyboard/` and then click on the directory that matches the version of CircuitPython you're using and copy the contents of that directory to your CIRCUITPY drive.

Your CIRCUITPY drive should now look similar to the following image:

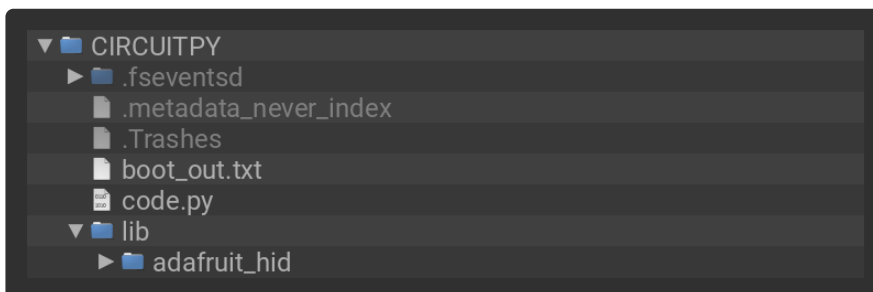

This example has been updated for version 4+ of the CircuitPython HID library. On the CircuitPlayground Express this library is built into CircuitPython. So, please use the latest version of CircuitPython as well. (At least 5.0.0-beta.3)

```

# SPDX-FileCopyrightText: 2017 Limor Fried for Adafruit Industries
#
# SPDX-License-Identifier: MIT

# Circuit Playground HID Keyboard

import time

import board
import usb_hid
from adafruit_hid.keyboard import Keyboard
from adafruit_hid.keyboard_layout_us import KeyboardLayoutUS
from adafruit_hid.keycode import Keycode
from digitalio import DigitalInOut, Direction, Pull

# A simple neat keyboard demo in CircuitPython

# The button pins we'll use, each will have an internal pulldown
buttonpins = [board.BUTTON_A, board.BUTTON_B]
# our array of button objects
buttons = []
# The keycode sent for each button, will be paired with a control key
buttonkeys = [Keycode.A, "Hello World!\n"]
controlkey = Keycode.SHIFT

# the keyboard object!
# sleep for a bit to avoid a race condition on some systems
time.sleep(1)
kbd = Keyboard(usb_hid.devices)
# we're americans :)
layout = KeyboardLayoutUS(kbd)

# make all pin objects, make them inputs with pulldowns
for pin in buttonpins:
    button = DigitalInOut(pin)
    button.direction = Direction.INPUT
    button.pull = Pull.DOWN
    buttons.append(button)

led = DigitalInOut(board.D13)
led.direction = Direction.OUTPUT

print("Waiting for button presses")

while True:
    # check each button
    # when pressed, the LED will light up,
    # when released, the keycode or string will be sent
    # this prevents rapid-fire repeats!
    for button in buttons:
        if button.value: # pressed?
            i = buttons.index(button)
            print("Button #%d Pressed" % i)

            # turn on the LED
            led.value = True

            while button.value:
                pass # wait for it to be released!
            # type the keycode or string
            k = buttonkeys[i] # get the corresponding keycode or string
            if isinstance(k, str):
                layout.write(k)
            else:
                kbd.press(controlkey, k) # press...
                kbd.release_all() # release!

            # turn off the LED

```

```
led.value = False
time.sleep(0.01)
```

Press Button A or Button B to have the keypresses sent.

The Keyboard and Layout object are created, we only have US right now (if you make other layouts please submit a GitHub pull request!)

```
# the keyboard object!
kbd = Keyboard(usb_hid.devices)
# we're americans :)
layout = KeyboardLayoutUS(kbd)
```

Then you can send key-down's with `kbd.press(keycode, ...)` You can have up to 6 keycode presses at once. Note that these are keycodes so if you want to send a capital A, you need both SHIFT and A. Don't forget to call `kbd.release_all()` soon after or you'll have a stuck key which is really annoying!

You can also send full strings, with `layout.write("Hello World!\n")` - it will use the layout to determine the keycodes to press.

For more detail check out the documentation at <https://circuitpython.readthedocs.io/projects/hid/en/latest/>

## CircuitPython CPU Temp

There is a CPU temperature sensor built into every ATSAM21, ATSAM51 and nRF52840 chips. CircuitPython makes it really simple to read the data from this sensor. This works on the Adafruit CircuitPython boards it's built into the microcontroller used for these boards.

The data is read using two simple commands. We're going to enter them in the REPL. Plug in your board, [connect to the serial console \(\)](#), and [enter the REPL \(\)](#). Then, enter the following commands into the REPL:

```
import microcontroller
microcontroller.cpu.temperature
```

That's it! You've printed the temperature in Celsius to the REPL. Note that it's not exactly the ambient temperature and it's not super precise. But it's close!

```
Adafruit CircuitPython 2.2.4 on 2018-03-07; Adafruit Metro M0 Express with samd21g18
>>> import microcontroller
>>> microcontroller.cpu.temperature
21.8071
>>>
```

If you'd like to print it out in Fahrenheit, use this simple formula: Celsius \* (9/5) + 32. It's super easy to do math using CircuitPython. Check it out!

```
>>> microcontroller.cpu.temperature * (9 / 5) + 32
70.8655
>>>
```

Note that the temperature sensor built into the nRF52840 has a resolution of 0.25 degrees Celsius, so any temperature you print out will be in 0.25 degree increments.

---

## CircuitPython Storage

CircuitPython-compatible microcontrollers show up as a CIRCUITPY drive when plugged into your computer, allowing you to edit code directly on the board. Perhaps you've wondered whether or not you can write data from CircuitPython directly to the board to act as a data logger. The answer is yes!

The `storage` module in CircuitPython enables you to write code that allows CircuitPython to write data to the CIRCUITPY drive. This process requires you to include a `boot.py` file on your CIRCUITPY drive, along side your `code.py` file.

The `boot.py` file is special - the code within it is executed when CircuitPython starts up, either from a hard reset or powering up the board. It is not run on soft reset, for example, if you reload the board from the serial console or the REPL. This is in contrast to the code within `code.py`, which is executed after CircuitPython is already running.

The CIRCUITPY drive is typically writable by your computer; this is what allows you to edit your code directly on the board. The reason you need a `boot.py` file is that you have to set the filesystem to be read-only by your computer to allow it to be writable by CircuitPython. This is because CircuitPython cannot write to the filesystem at the same time as your computer. Doing so can lead to filesystem corruption and loss of all content on the drive, so CircuitPython is designed to only allow one at a time.

You can only have either your computer edit the CIRCUITPY drive files, or CircuitPython. You cannot have both write to the drive at the same time. (Bad Things Will Happen so we do not allow you to do it!)

## boot.py

```
# SPDX-FileCopyrightText: 2017 Limor Fried for Adafruit Industries
#
# SPDX-License-Identifier: MIT

"""CircuitPython Essentials Storage logging boot.py file"""
import board
import digitalio
import storage

# For Gemma M0, Trinket M0, Metro M0/M4 Express, ItsyBitsy M0/M4 Express
switch = digitalio.DigitalInOut(board.D2)

# For Feather M0/M4 Express
# switch = digitalio.DigitalInOut(board.D5)

# For Circuit Playground Express, Circuit Playground Bluefruit
# switch = digitalio.DigitalInOut(board.D7)

switch.direction = digitalio.Direction.INPUT
switch.pull = digitalio.Pull.UP

# If the switch pin is connected to ground CircuitPython can write to the drive
storage.remount("/", switch.value)
```

The `storage.remount()` command has a `readonly` keyword argument. This argument refers to the read/write state of CircuitPython. It does NOT refer to the read/write state of your computer.

When the physical pin is connected to ground, it returns `False`. The `readonly` argument in `boot.py` is set to the `value` of the pin. When the `value=True`, the CIRCUITPY drive is read-only to CircuitPython (and writable by your computer). When the `value=False`, the CIRCUITPY drive is writable by CircuitPython (and read-only by your computer).

For Gemma M0, Trinket M0, Metro M0 Express, Metro M4 Express, ItsyBitsy M0 Express and ItsyBitsy M4 Express, no changes to the initial code are needed.

For Feather M0 Express and Feather M4 Express, comment out `switch = digitalio.DigitalInOut(board.D2)`, and uncomment `switch = digitalio.DigitalInOut(board.D5)`.

For Circuit Playground Express and Circuit Playground Bluefruit, comment out `switch = digitalio.DigitalInOut(board.D2)`, and uncomment `switch = digitalio.DigitalInOut(board.D7)`. Remember, D7 is the onboard slide switch, so there's no extra wires or alligator clips needed.

On the Circuit Playground Express or Circuit Playground Bluefruit, the switch is in the right position (closer to the ear icon on the silkscreen) it returns `False`, and the CIRC

UITPY drive will be writable by CircuitPython. If the switch is in the left position (closer to the music icon on the silkscreen), it returns `True`, and the CIRCUITPY drive will be writable by your computer.

Remember: To "comment out" a line, put a # and a space before it. To "uncomment" a line, remove the # + space from the beginning of the line.

## Installing Project Code

In the example below, click the Download Project Bundle button below to download the necessary libraries and the code.py file in a zip file. Extract the contents of the zip file, open the directory CircuitPython\_Essentials/CircuitPython\_Logger/ and then click on the directory that matches the version of CircuitPython you're using and copy the contents of that directory to your CIRCUITPY drive.

Your CIRCUITPY drive should now look similar to the following image:

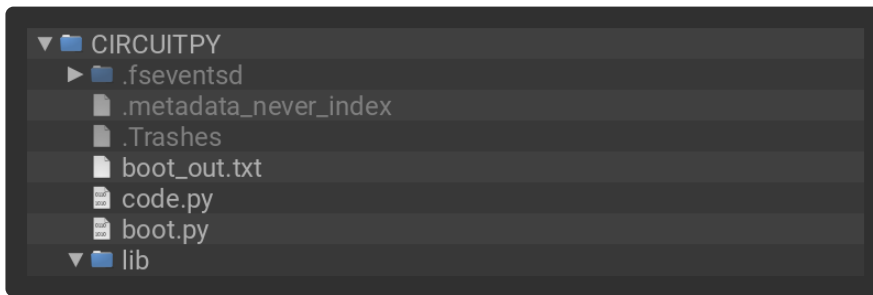

```
# SPDX-FileCopyrightText: 2017 Limor Fried for Adafruit Industries
#
# SPDX-License-Identifier: MIT

"""CircuitPython Essentials Storage logging example"""
import time
import board
import digitalio
import microcontroller

# For most CircuitPython boards:
led = digitalio.DigitalInOut(board.LED)
# For QT Py M0:
# led = digitalio.DigitalInOut(board.SCK)
led.switch_to_output()

try:
    with open("/temperature.txt", "a") as fp:
        while True:
            temp = microcontroller.cpu.temperature
            # do the C-to-F conversion here if you would like
            fp.write('{0:f}\n'.format(temp))
            fp.flush()
            led.value = not led.value
            time.sleep(1)
except OSError as e: # Typically when the filesystem isn't writeable...
    delay = 0.5 # ...blink the LED every half second.
    if e.args[0] == 28: # If the file system is full...
```

```
delay = 0.25 # ...blink the LED faster!
while True:
    led.value = not led.value
    time.sleep(delay)
```

The filesystem will NOT automatically be set to read-only after you copy these files over! You'll still be able to edit files on CIRCUITPY after saving this boot.py.

## Logging the Temperature

The way boot.py works is by checking to see if the pin you specified in the switch setup in your code is connected to a ground pin. If it is, it changes the read-write state of the file system, so the CircuitPython core can begin logging the temperature to the board.

For help finding the correct pins, see the wiring diagrams and information in the [Find the Pins section of the CircuitPython Digital In & Out guide \(\)](#). Instead of wiring up a switch, however, you'll be connecting the pin directly to ground with alligator clips or jumper wires.

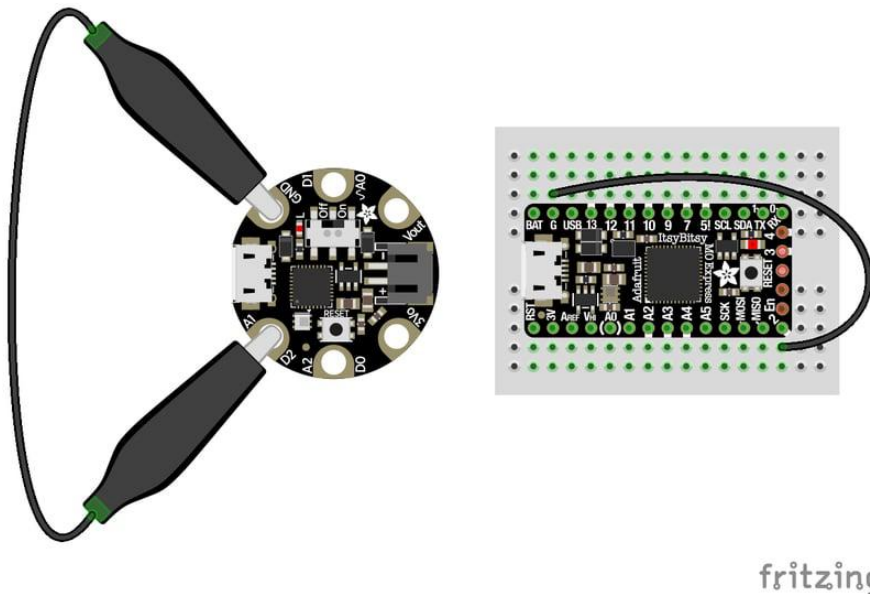

boot.py only runs on first boot of the device, not if you re-load the serial console with ctrl+D or if you save a file. You must EJECT the USB drive, then physically press the reset button!

Once you copied the files to your board, eject it and unplug it from your computer. If you're using your Circuit Playground Express, all you have to do is make sure the switch is to the right. Otherwise, use alligator clips or jumper wires to connect the chosen pin to ground. Then, plug your board back into your computer.

You will not be able to edit code on your CIRCUITPY drive anymore!

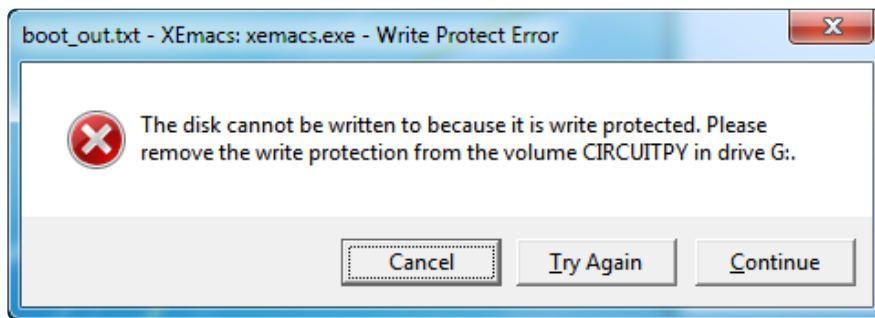

The red LED should blink once a second and you will see a new temperature.txt file on CIRCUITPY.

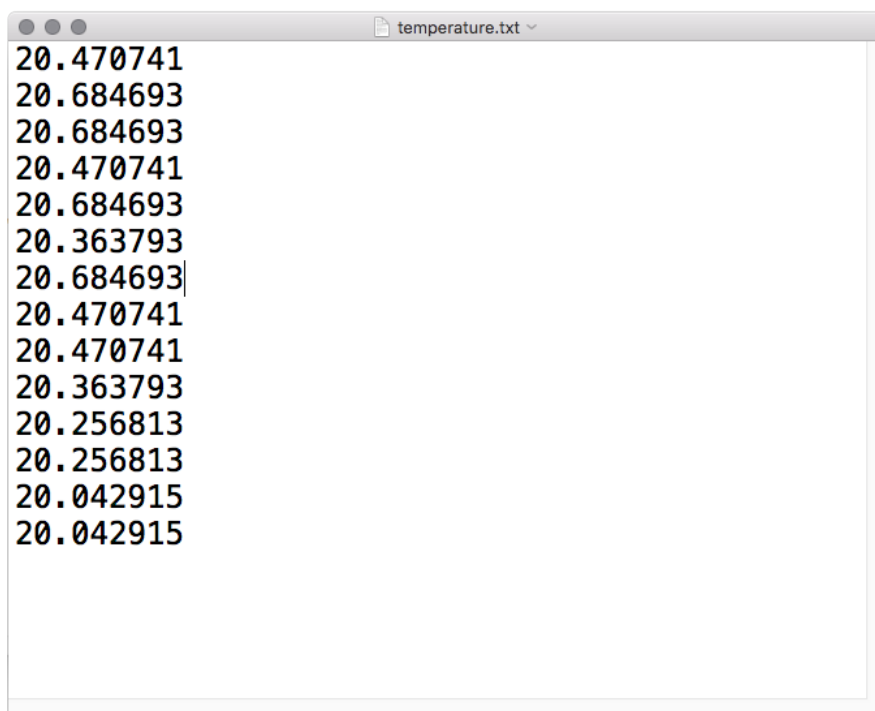

This file gets updated once per second, but you won't see data come in live. Instead, when you're ready to grab the data, eject and unplug your board. For CPX, move the switch to the left, otherwise remove the wire connecting the pin to ground. Now it will be possible for you to write to the filesystem from your computer again, but it will not be logging data.

We have a more detailed guide on this project available here: [CPU Temperature Logging with CircuitPython \(\)](#). If you'd like more details, check it out!

---

# Playground Temperature

Though the following example uses the Circuit Playground Express to demonstrate, the code works exactly the same way with the Circuit Playground Bluefruit. Simply copy the code and follow along with your Circuit Playground Bluefruit!

But wait! There's more -- the Circuit Playground Express can also tell the temperature!

How, you ask? With a built-in thermistor. This little sensor is a thermally sensitive resistor, meaning its resistance changes based on temperature.

We can access its readings in CircuitPython by importing the `adafruit_thermistor` library, and then using the `board.TEMPERATURE` pin to read the thermistor value.

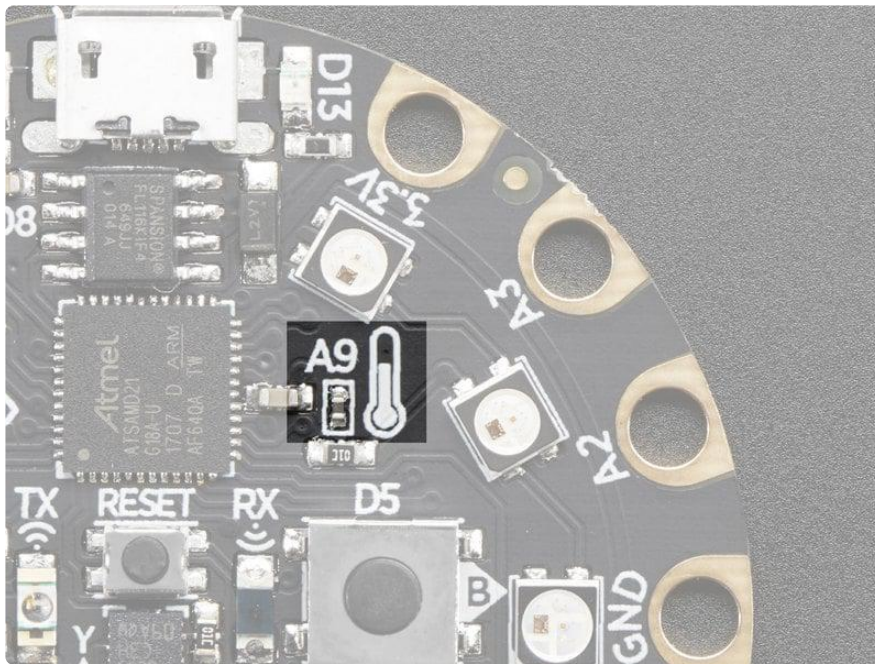

In the example below, click the Download Project Bundle button below to download the necessary libraries and the code.py file in a zip file. Extract the contents of the zip file, open the directory `Introducing_CircuitPlaygroundExpress/CircuitPlaygroundExpress_Temperature/` and then click on the directory that matches the version of CircuitPython you're using and copy the contents of that directory to your CIRCUITPY drive.

Your CIRCUITPY drive should now look similar to the following image:

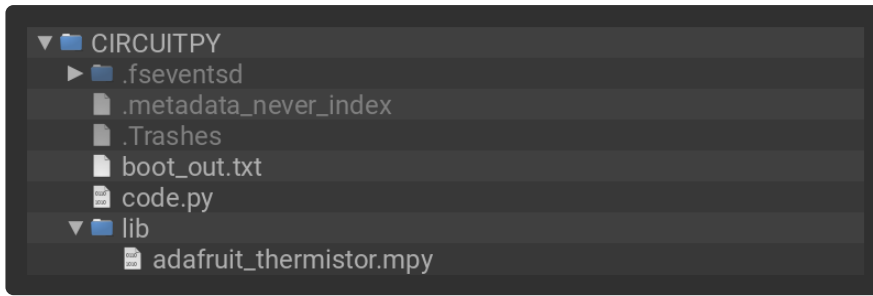

```
# SPDX-FileCopyrightText: 2017 John Edgar Park for Adafruit Industries
#
# SPDX-License-Identifier: MIT

# Circuit Playground Temperature
# Reads the on-board temperature sensor and prints the value

import time

import adafruit_thermistor
import board

thermistor = adafruit_thermistor.Thermistor(
    board.TEMPERATURE, 10000, 10000, 25, 3950)

while True:
    temp_c = thermistor.temperature
    temp_f = thermistor.temperature * 9 / 5 + 32
    print("Temperature is: %f C and %f F" % (temp_c, temp_f))

    time.sleep(0.25)
```

Then, open up a REPL session and you'll see the temperature readings in both Celsius and Fahrenheit.

Try placing your finger over the sensor (you'll see a thermometer icon on the board) and watch the readings change.

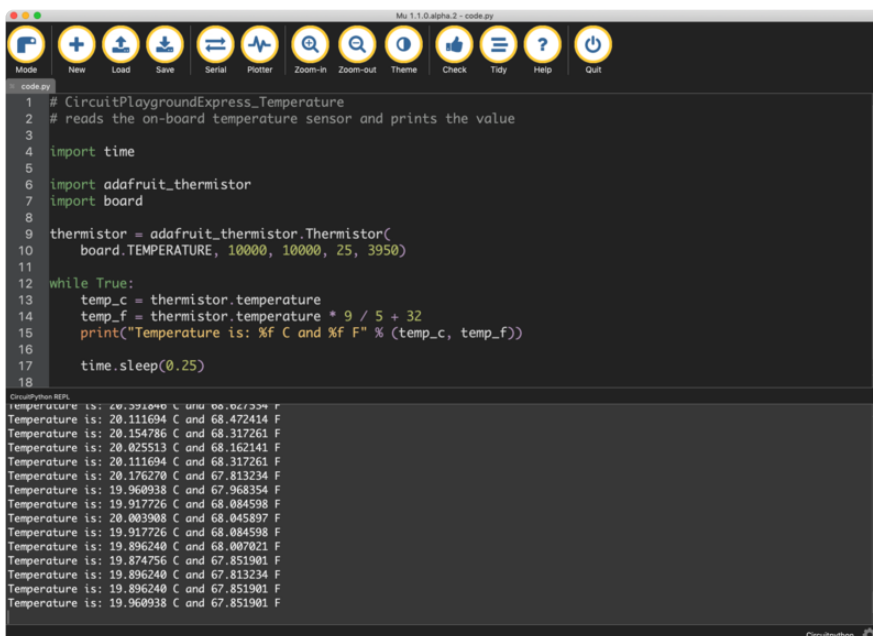

---

# Playground Light Sensor

Though the following example uses the Circuit Playground Express to demonstrate, the code works exactly the same way with the Circuit Playground Bluefruit. Simply copy the code and follow along with your Circuit Playground Bluefruit!

The Circuit Playground Express can see you! OK, not really. That would be creepy.

But, it can sense light and dark, as well as colors and even your pulse!!

The Light Sensor in the upper left of the board (look for the eye icon) is a phototransistor. Here's how to use it as a light sensor:

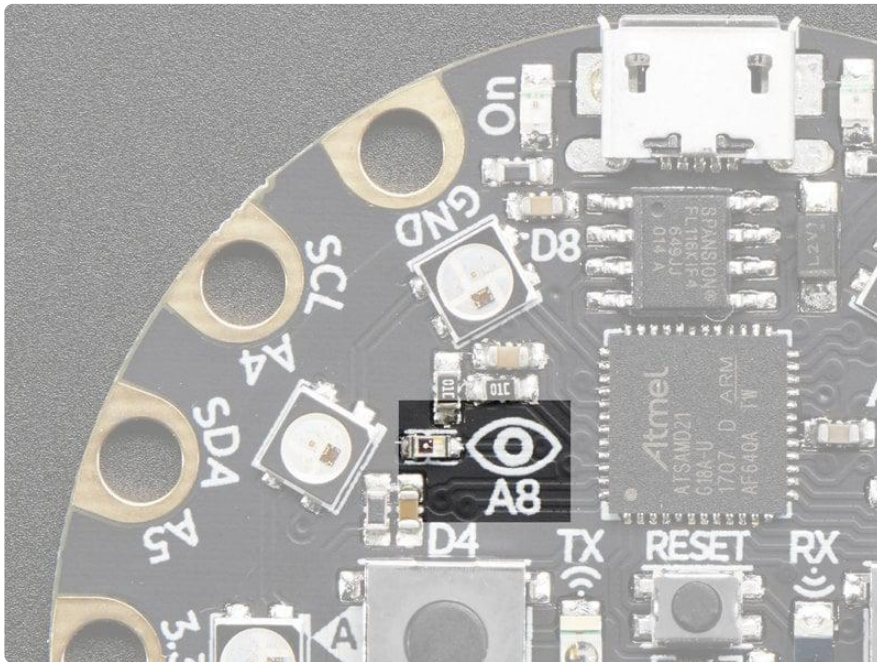

In the example below, click the Download Project Bundle button below to download the necessary libraries and the code.py file in a zip file. Extract the contents of the zip file, open the directory `Introducing_CircuitPlaygroundExpress/CircuitPlaygroundExpress_LightSensor/` and then click on the directory that matches the version of CircuitPython you're using and copy the contents of that directory to your CIRCUITPY drive.

Your CIRCUITPY drive should now look similar to the following image:

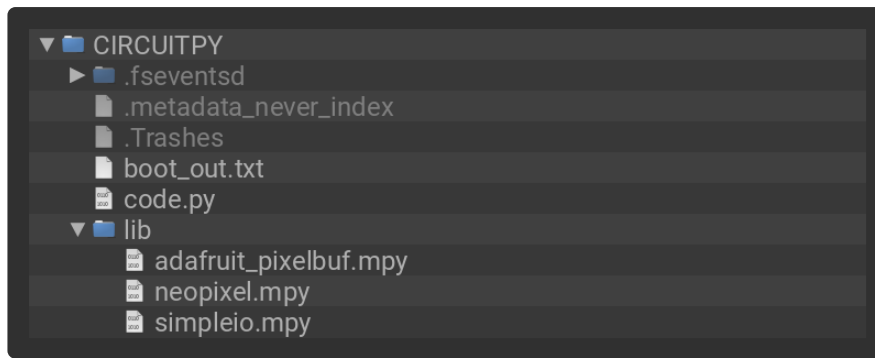

```
# SPDX-FileCopyrightText: 2017 John Edgar Park for Adafruit Industries
#
# SPDX-License-Identifier: MIT

# Circuit Playground Light Sensor
# Reads the on-board light sensor and graphs the brightness with NeoPixels

import time
import board
import neopixel
import analogio
import simpleio

pixels = neopixel.NeoPixel(board.NEOPIXEL, 10, brightness=.05, auto_write=False)
pixels.fill((0, 0, 0))
pixels.show()

light = analogio.AnalogIn(board.LIGHT)

while True:
    # light value remapped to pixel position
    peak = simpleio.map_range(light.value, 2000, 62000, 0, 9)
    print(light.value)
    print(int(peak))

    for i in range(0, 9, 1):
        if i <= peak:
            pixels[i] = (0, 255, 0)
        else:
            pixels[i] = (0, 0, 0)
    pixels.show()

    time.sleep(0.01)
```

The code reads the light sensor and then lights up the NeoPixels like a bar graph depending on the light level. Try waving your hand over it, or shining it with a flashlight to see it change!

---

## Playground Drum Machine

Though the following example uses the Circuit Playground Express to demonstrate, the code works exactly the same way with the Circuit Playground Bluefruit. Simply copy the code and follow along with your Circuit Playground Bluefruit!

A wise man once said, "Nothing sounds better than an Eight-O-Eight."

(That wise man was Adam Horovitz of the Beastie Boys.)

The 808 to which Ad-Rock was referring is the Roland TR-808 drum machine. Let's build a little Circuit Playground Express tribute to the venerable 808! Instead of a full-blown drum pattern sequencer, we'll just focus on the machine's pads which are used for finger drumming to play back sampled drum sounds.

We can use the capacitive touch pads on the Circuit Playground Express as triggers, and small .wav files for our drum sounds!

## Installing Project Code

To use with CircuitPython, you need to first install a few libraries, into the lib folder on your CIRCUITPY drive. Then you need to update code.py with the example script.

Thankfully, we can do this in one go. In the example below, click the Download Project Bundle button below to download the necessary libraries and the code.py file in a zip file. Extract the contents of the zip file, open the directory `Introducing_CircuitPlaygroundExpress/CircuitPlaygroundExpress_808_Drum_Machine/` and then click on the directory that matches the version of CircuitPython you're using and copy the contents of that directory to your CIRCUITPY drive.

Your CIRCUITPY drive should now look similar to the following image:

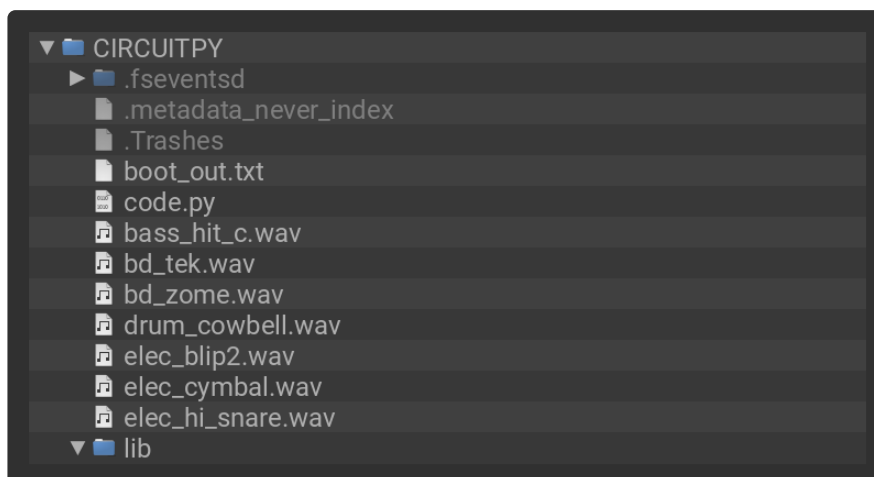

```
# SPDX-FileCopyrightText: 2019 Kattni Rembor for Adafruit Industries
#
# SPDX-License-Identifier: MIT

# Circuit Playground 808 Drum machine
import time
import board
```

```

import touchio
import digitalio

try:
    from audiocore import WaveFile
except ImportError:
    from audioio import WaveFile

try:
    from audioio import AudioOut
except ImportError:
    try:
        from audiopwmio import PWMAudioOut as AudioOut
    except ImportError:
        pass # not always supported by every board!

bpm = 120 # Beats per minute, change this to suit your tempo

# Enable the speaker
speaker_enable = digitalio.DigitalInOut(board.SPEAKER_ENABLE)
speaker_enable.direction = digitalio.Direction.OUTPUT
speaker_enable.value = True

# Make the input capacitive touchpads
capPins = (board.A1, board.A2, board.A3, board.A4, board.A5,
           board.A6, board.TX)

touchPad = []
for i in range(7):
    touchPad.append(touchio.TouchIn(capPins[i]))

# The seven files assigned to the touchpads
audiofiles = ["bd_tek.wav", "elec_hi_snare.wav", "elec_cymbal.wav",
              "elec_blip2.wav", "bd_zome.wav", "bass_hit_c.wav",
              "drum_cowbell.wav"]

audio = AudioOut(board.SPEAKER)

def play_file(filename):
    print("playing file " + filename)
    file = open(filename, "rb")
    wave = WaveFile(file)
    audio.play(wave)
    time.sleep(bpm / 960) # Sixteenth note delay

while True:
    for i in range(7):
        if touchPad[i].value:
            play_file(audiofiles[i])

```

Try it out! When you tap the capacitive pads, the corresponding drum sample is triggered!!

Things are a bit cramped, admittedly, so you can try adding foil, copper tape, alligator clips, etc. in order to increase the surface area and physical space you have for your drumming!

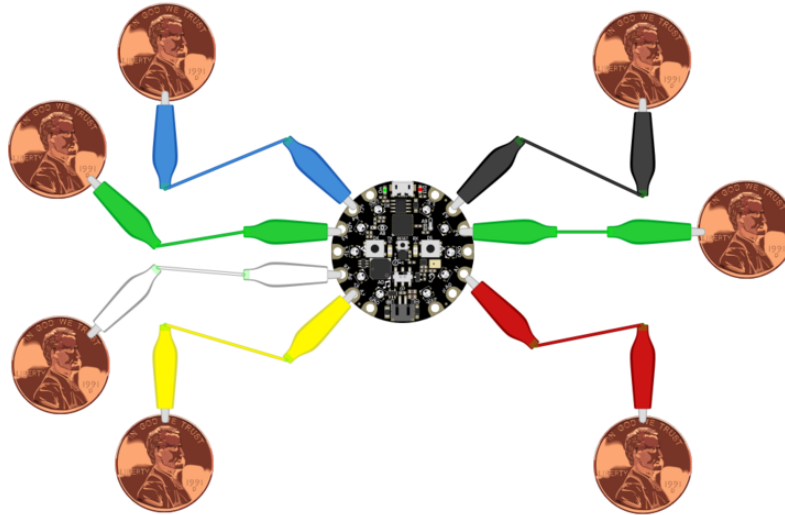

Capacitance is calibrated at startup, so you may need to reset the board after attaching leads to the pads!

If you want to use your own sound files, you can! Record, sample, remix, or simply download files from a sound file sight, such as [freesample.org](https://freesample.org). Then, to make sure you have the files converted to the proper specifications, [check out this guide here \(\)](#) that'll show you how! Spoiler alert: you'll need to make a small, 22Khz (or lower), 16 bit PCM, mono .wav file!

Want to listen to your Drum Machine at body movin' volumes? No problem! Hook up an [1/8" \(\)](#) or [1/4" phono output \(\)](#) to the GND and A0/Audio pads, then plug in to an amp!! I tried it on a small guitar amp and it sounds great.

---

## Playground Sound Meter

Though the following example uses the Circuit Playground Express to demonstrate, the code works exactly the same way with the Circuit Playground Bluefruit. Simply copy the code and follow along with your Circuit Playground Bluefruit!

Use the microphone on your Circuit Playground Express to measure sound levels and display them on a VU-meter-like display!

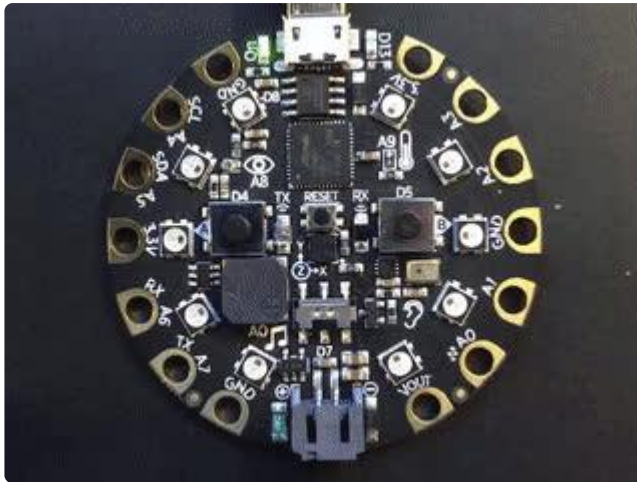

The program is below. There are many settings that you can change to make the readings more or less sensitive and the display more or less jumpy. Try changing `CURVE` to be 4 or 1 or 10 or -2 and see what happens.

The program samples audio for a short time and then computes the energy in the sample (corresponding to volume) using a [Root-Mean-Square \(\)](#) computation (RMS). You could try varying the sample size if you like.

The `log_scale()` function varies the number of NeoPixels lit in an exponential way, because sound levels can vary by many factors of 10 between loud and soft. Try varying how it's computed to see what happens.

The program takes one sample when it first starts to set a "quiet" sound level. If that doesn't work for you, set `input_floor` to be a fixed number. If the meter seems too sensitive, try changing `input_ceiling = input_floor + 500` to be `input_ceiling = input_floor + 2000` or higher. Or go the other way.

You can also change the colors. Try different ways of computing `volume_color(i)` for more of a rainbow effect, or make it a constant if you don't like changing colors.

## Installing Project Code

To use with CircuitPython, you need to first install a few libraries, into the lib folder on your CIRCUITPY drive. Then you need to update `code.py` with the example script.

Thankfully, we can do this in one go. In the example below, click the Download Project Bundle button below to download the necessary libraries and the `code.py` file in a zip file. Extract the contents of the zip file, open the directory `Introducing_CircuitP laygroundExpress_SoundMeter/` and then click on the directory that matches the

version of CircuitPython you're using and copy the contents of that directory to your CIRCUITPY drive.

Your CIRCUITPY drive should now look similar to the following image:

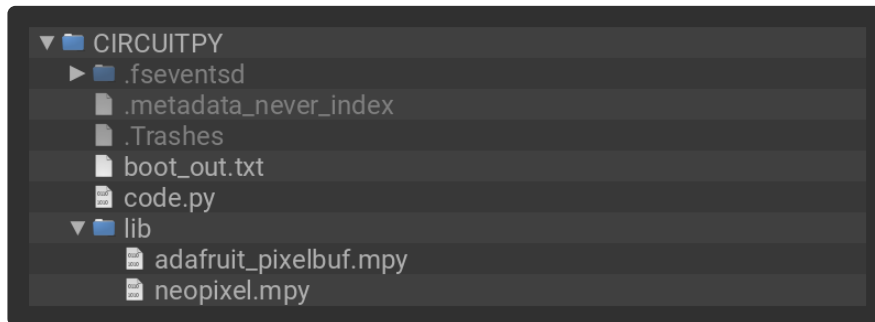

```
# SPDX-FileCopyrightText: 2017 Dan Halbert for Adafruit Industries
# SPDX-FileCopyrightText: 2017 Tony DiCola for Adafruit Industries
# SPDX-FileCopyrightText: 2017 Kattni Rembor for Adafruit Industries
#
# SPDX-License-Identifier: MIT

# The MIT License (MIT)
#
# Copyright (c) 2017 Dan Halbert for Adafruit Industries
# Copyright (c) 2017 Kattni Rembor, Tony DiCola for Adafruit Industries
#
# Permission is hereby granted, free of charge, to any person obtaining a copy
# of this software and associated documentation files (the "Software"), to deal
# in the Software without restriction, including without limitation the rights
# to use, copy, modify, merge, publish, distribute, sublicense, and/or sell
# copies of the Software, and to permit persons to whom the Software is
# furnished to do so, subject to the following conditions:
#
# The above copyright notice and this permission notice shall be included in
# all copies or substantial portions of the Software.
#
# THE SOFTWARE IS PROVIDED "AS IS", WITHOUT WARRANTY OF ANY KIND, EXPRESS OR
# IMPLIED, INCLUDING BUT NOT LIMITED TO THE WARRANTIES OF MERCHANTABILITY,
# FITNESS FOR A PARTICULAR PURPOSE AND NONINFRINGEMENT. IN NO EVENT SHALL THE
# AUTHORS OR COPYRIGHT HOLDERS BE LIABLE FOR ANY CLAIM, DAMAGES OR OTHER
# LIABILITY, WHETHER IN AN ACTION OF CONTRACT, TORT OR OTHERWISE, ARISING FROM,
# OUT OF OR IN CONNECTION WITH THE SOFTWARE OR THE USE OR OTHER DEALINGS IN
# THE SOFTWARE.

# Circuit Playground Sound Meter

import array
import math
import audiobusio
import board
import neopixel

# Color of the peak pixel.
PEAK_COLOR = (100, 0, 255)
# Number of total pixels - 10 build into Circuit Playground
NUM_PIXELS = 10

# Exponential scaling factor.
# Should probably be in range -10 .. 10 to be reasonable.
CURVE = 2
SCALE_EXPONENT = math.pow(10, CURVE * -0.1)

# Number of samples to read at once.
```

```

NUM_SAMPLES = 160

# Restrict value to be between floor and ceiling.
def constrain(value, floor, ceiling):
    return max(floor, min(value, ceiling))

# Scale input_value between output_min and output_max, exponentially.
def log_scale(input_value, input_min, input_max, output_min, output_max):
    normalized_input_value = (input_value - input_min) / \
        (input_max - input_min)
    return output_min + \
        math.pow(normalized_input_value, SCALE_EXPONENT) \
        * (output_max - output_min)

# Remove DC bias before computing RMS.
def normalized_rms(values):
    minbuf = int(mean(values))
    samples_sum = sum(
        float(sample - minbuf) * (sample - minbuf)
        for sample in values
    )

    return math.sqrt(samples_sum / len(values))

def mean(values):
    return sum(values) / len(values)

def volume_color(volume):
    return 200, volume * (255 // NUM_PIXELS), 0

# Main program

# Set up NeoPixels and turn them all off.
pixels = neopixel.NeoPixel(board.NEOPIXEL, NUM_PIXELS, brightness=0.1,
    auto_write=False)
pixels.fill(0)
pixels.show()

mic = audiobusio.PDMIn(board.MICROPHONE_CLOCK, board.MICROPHONE_DATA,
    sample_rate=16000, bit_depth=16)

# Record an initial sample to calibrate. Assume it's quiet when we start.
samples = array.array('H', [0] * NUM_SAMPLES)
mic.record(samples, len(samples))
# Set lowest level to expect, plus a little.
input_floor = normalized_rms(samples) + 10
# OR: used a fixed floor
# input_floor = 50

# You might want to print the input_floor to help adjust other values.
# print(input_floor)

# Corresponds to sensitivity: lower means more pixels light up with lower sound
# Adjust this as you see fit.
input_ceiling = input_floor + 500

peak = 0
while True:
    mic.record(samples, len(samples))
    magnitude = normalized_rms(samples)
    # You might want to print this to see the values.
    # print(magnitude)

```

```
# Compute scaled logarithmic reading in the range 0 to NUM_PIXELS
c = log_scale(constrain(magnitude, input_floor, input_ceiling),
              input_floor, input_ceiling, 0, NUM_PIXELS)

# Light up pixels that are below the scaled and interpolated magnitude.
pixels.fill(0)
for i in range(NUM_PIXELS):
    if i < c:
        pixels[i] = volume_color(i)
    # Light up the peak pixel and animate it slowly dropping.
    if c >= peak:
        peak = min(c, NUM_PIXELS - 1)
    elif peak > 0:
        peak = peak - 1
    if peak > 0:
        pixels[int(peak)] = PEAK_COLOR
pixels.show()
```

## Playground Color Picker

You can use your Circuit Playground Bluefruit with the [Adafruit Bluefruit LE Connect \(\)](#) mobile app to control the NeoPixel RGB LEDs on the CPB!

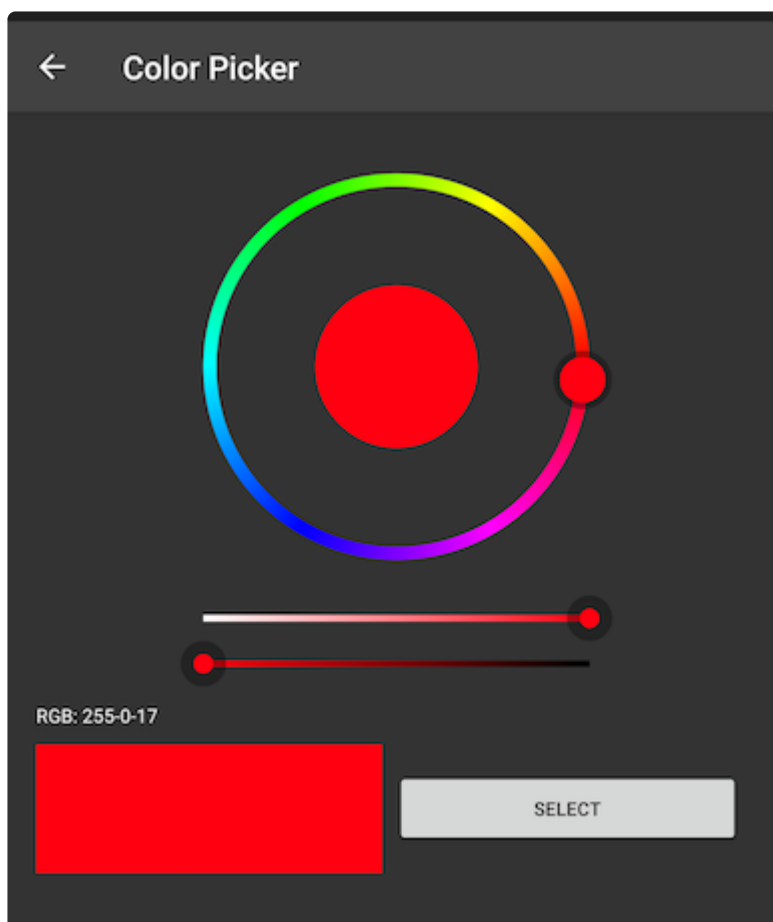

## Installing Project Code

To use with CircuitPython, you need to first install a few libraries, into the lib folder on your CIRCUITPY drive. Then you need to update code.py with the example script.

Thankfully, we can do this in one go. In the example below, click the Download Project Bundle button below to download the necessary libraries and the code.py file in a zip file. Extract the contents of the zip file, open the directory examples/ and then click on the directory that matches the version of CircuitPython you're using and copy the contents of that directory to your CIRCUITPY drive.

Your CIRCUITPY drive should now look similar to the following image:

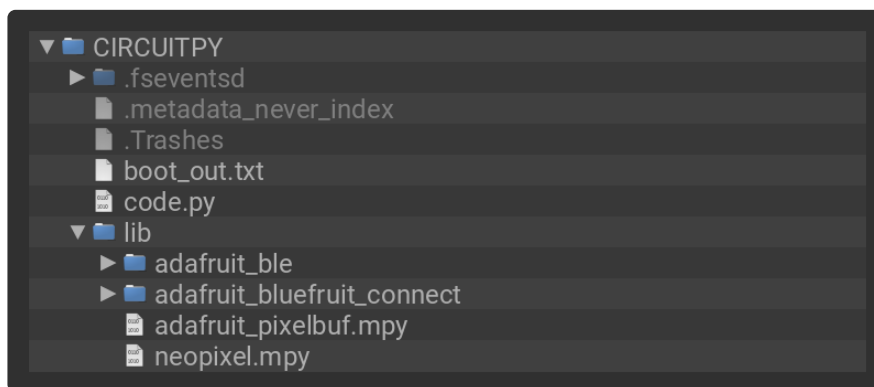

```
# SPDX-FileCopyrightText: 2020 ladyada for Adafruit Industries
# SPDX-License-Identifier: MIT

# CircuitPython NeoPixel Color Picker Example

import board
import neopixel

from adafruit_bluefruit_connect.packet import Packet
from adafruit_bluefruit_connect.color_packet import ColorPacket

from adafruit_ble import BLERadio
from adafruit_ble.advertising.standard import ProvideServicesAdvertisement
from adafruit_ble.services.nordic import UARTService

ble = BLERadio()
uart_service = UARTService()
advertisement = ProvideServicesAdvertisement(uart_service)

pixels = neopixel.NeoPixel(board.NEOPIXEL, 10, brightness=0.1)

while True:
    # Advertise when not connected.
    ble.start_advertising(advertisement)
    while not ble.connected:
        pass
    ble.stop_advertising()

    while ble.connected:
        if uart_service.in_waiting:
            packet = Packet.from_stream(uart_service)
```

```
if isinstance(packet, ColorPacket):
    print(packet.color)
    pixels.fill(packet.color)
```

Connect to your board through the Adafruit Bluefruit LE Connect mobile app. If you need assistance, [check out this page on installing and using the app](#) ().

Once connected, from the device menu, tap on Controller, then Color Picker. Choose a color from the dial and tap Select (Android) or Send selected color (iOS). The LEDs will light up in the color you chose!

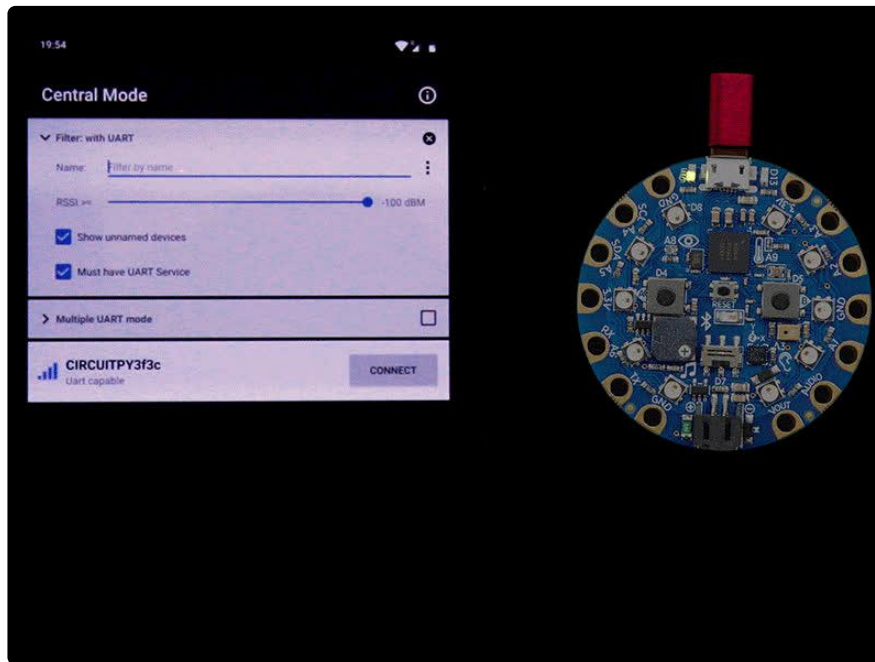

## Playground Bluetooth Plotter

The Circuit Playground Bluefruit has a built in light sensor that returns a light value and a temperature sensor that returns the temperature in degrees Celsius. The Adafruit Bluefruit LE Connect mobile app has a built in plotter function that you can use to plot any numerical information. This page will show you how to plot the light and temperature data from the Circuit Playground Bluefruit in the Bluefruit LE Connect app!

## Installing Project Code

To use with CircuitPython, you need to first install a few libraries, into the lib folder on your CIRCUITPY drive. Then you need to update code.py with the example script.

Thankfully, we can do this in one go. In the example below, click the Download Project Bundle button below to download the necessary libraries and the code.py file

in a zip file. Extract the contents of the zip file, open the directory examples/ and then click on the directory that matches the version of CircuitPython you're using and copy the contents of that directory to your CIRCUITPY drive.

Your CIRCUITPY drive should now look similar to the following image:



```
# SPDX-FileCopyrightText: 2020 ladyada for Adafruit Industries
# SPDX-License-Identifier: MIT

# CircuitPython Bluefruit LE Connect Plotter Example

import time
import board
import analogio
import adafruit_thermistor
from adafruit_ble import BLERadio
from adafruit_ble.advertising.standard import ProvideServicesAdvertisement
from adafruit_ble.services.nordic import UARTService

ble = BLERadio()
uart_server = UARTService()
advertisement = ProvideServicesAdvertisement(uart_server)

thermistor = adafruit_thermistor.Thermistor(board.TEMPERATURE, 10000, 10000, 25,
3950)
light = analogio.AnalogIn(board.LIGHT)

def scale(value):
    """Scale the light sensor values from 0-65535 (AnalogIn range)
    to 0-50 (arbitrarily chosen to plot well with temperature)"""
    return value / 65535 * 50

while True:
    # Advertise when not connected.
    ble.start_advertising(advertisement)
    while not ble.connected:
        pass
    ble.stop_advertising()

    while ble.connected:
        print((scale(light.value), thermistor.temperature))
        uart_server.write("{}\n".format(scale(light.value),
thermistor.temperature))
        time.sleep(0.1)
```

Connect to your board through the Adafruit Bluefruit LE Connect mobile app. If you need assistance, check out [the Bluefruit LE Connect Basics page in the Getting Started guide \(\)](#).

Once connected, tap Plotter.

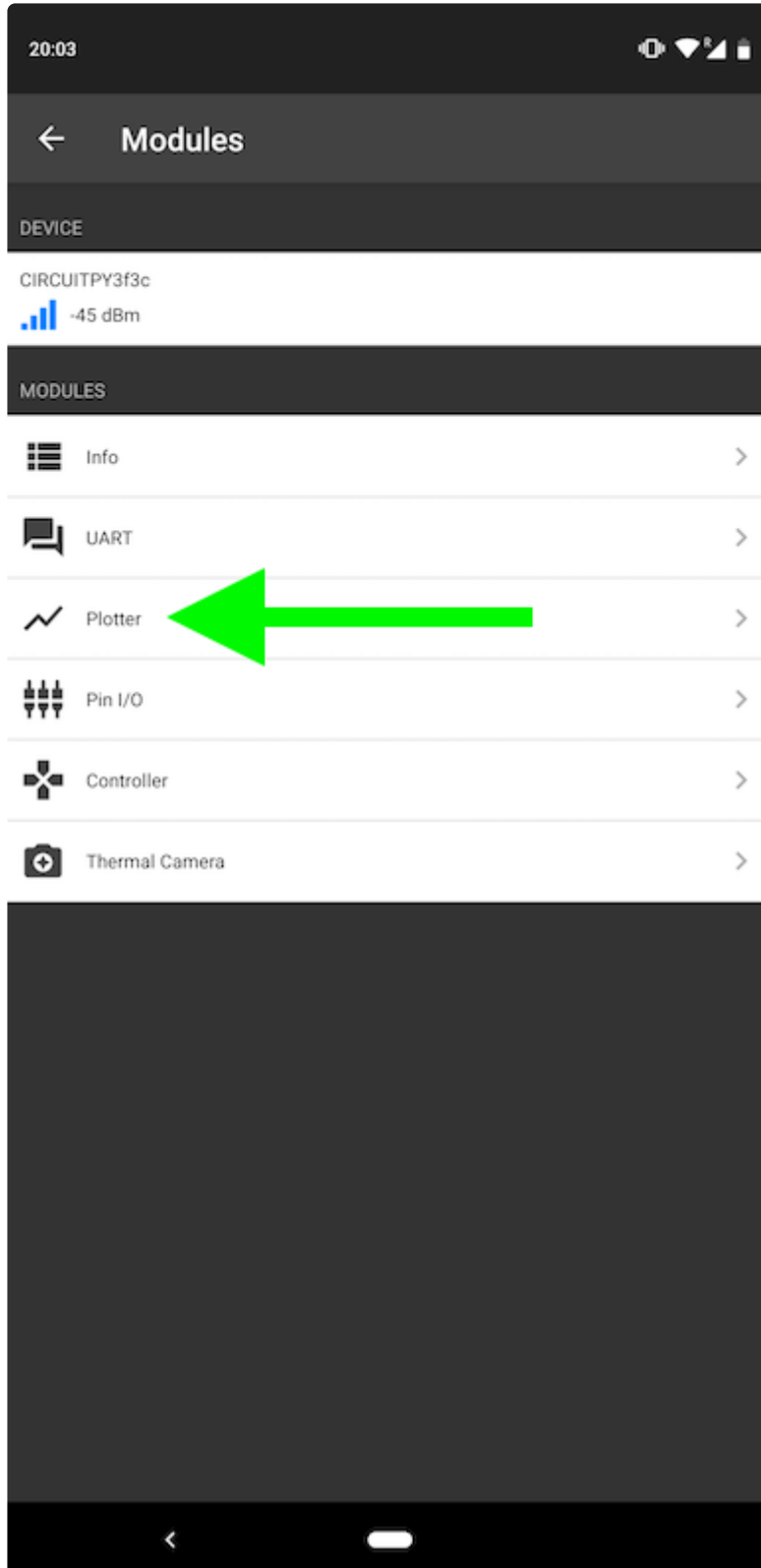

Your data should start plotting automatically. Try shining a light towards your Circuit Playground Bluefruit to see the light value line change. Try placing your finger over the thermistor (towards the top-right, labeled A9, next to the picture of a thermometer) to see the temperature value line change.

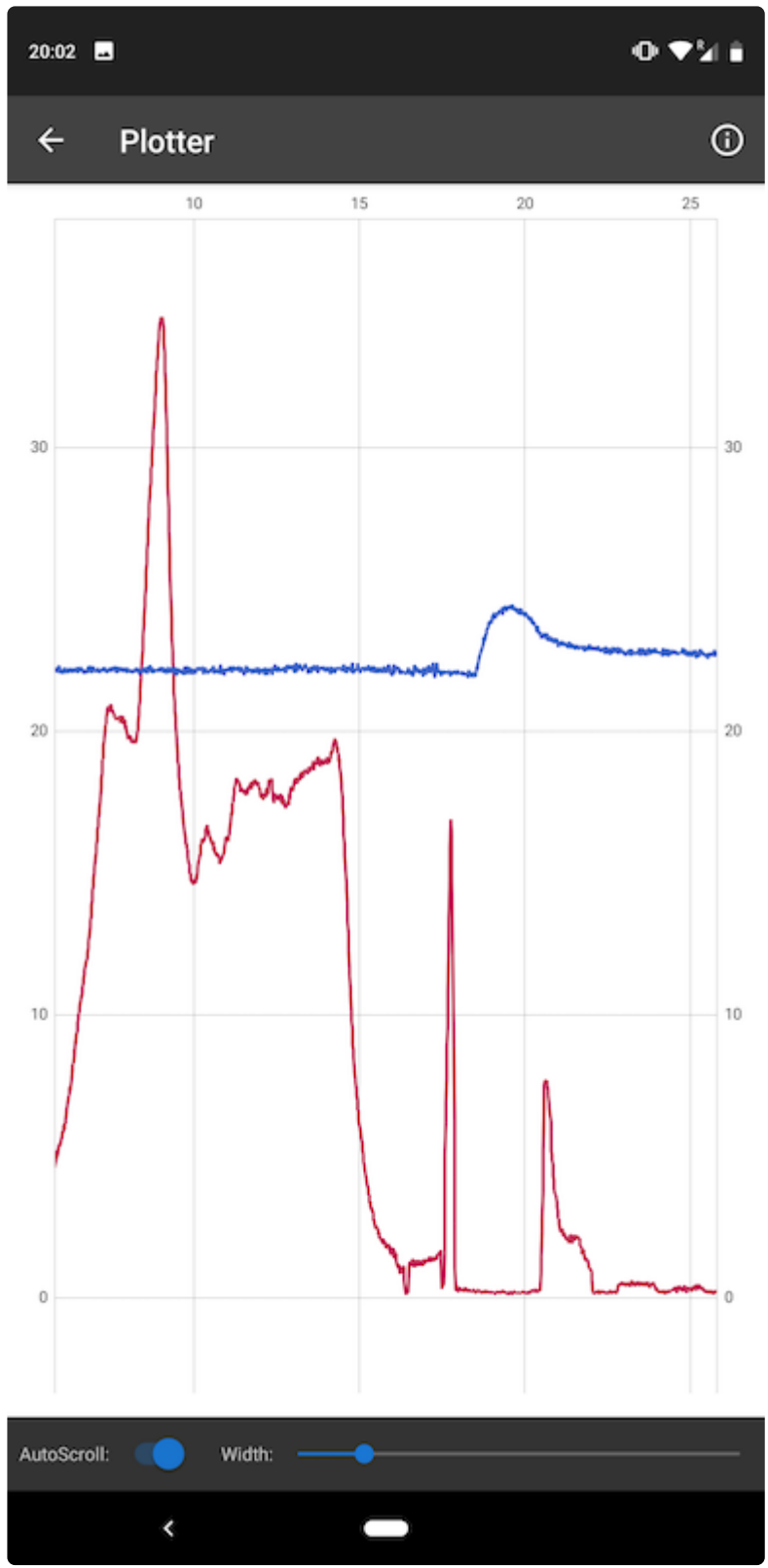

That's all there is to plotting numerical data with the Circuit Playground Bluefruit and the Adafruit Bluefruit LE Connect mobile app!

# Arduino Support Setup

You can install the Adafruit Bluefruit nRF52 BSP (Board Support Package) in two steps:

nRF52 support requires at least Arduino IDE version 1.8.15! Please make sure you have an up to date version before proceeding with this guide!

Please consult the FAQ section at the bottom of this page if you run into any problems installing or using this BSP!

## 1. BSP Installation

Recommended: Installing the BSP via the Board Manager

- [Download and install the Arduino IDE \(\)](#) (At least v1.8)
- Start the Arduino IDE
- Go into Preferences
- Add [https://adafruit.github.io/arduino-board-index/package\\_adafruit\\_index.json](https://adafruit.github.io/arduino-board-index/package_adafruit_index.json) as an 'Additional Board Manager URL' (see image below)

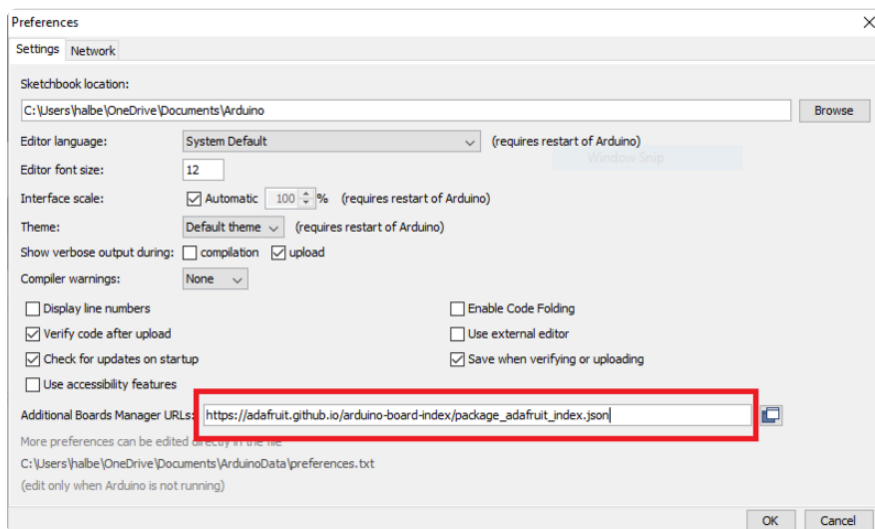

- Restart the Arduino IDE

- Open the Boards Manager option from the Tools -> Board menu and install 'Adafruit nRF52 by Adafruit' (see image below)

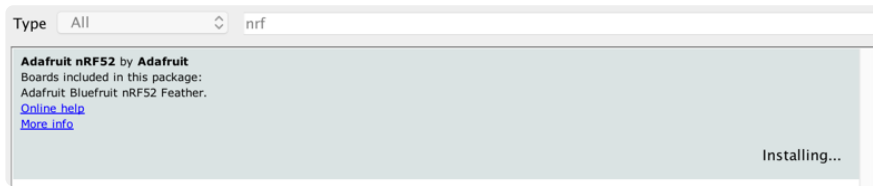

It will take up to a few minutes to finish installing the cross-compiling toolchain and tools associated with this BSP.

The delay during the installation stage shown in the image below is normal, please be patient and let the installation terminate normally:



Once the BSP is installed, select

- Adafruit Bluefruit nRF52832 Feather (for the nRF52 Feather)
- Adafruit Bluefruit nRF52840 Feather Express (for the nRF52840 Feather)
- Adafruit ItsyBitsy nRF52840 (for the Itsy '850)
- Adafruit Circuit Playground Bluefruit (for the CPB)
- etc...

from the Tools -> Board menu, which will update your system config to use the right compiler and settings for the nRF52:

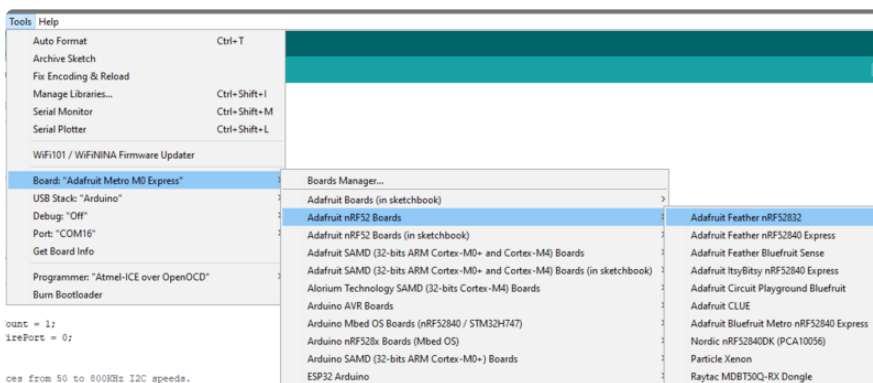

## 2. LINUX ONLY: adafruit-nrfutil Tool Installation

[adafruit-nrfutil \(\)](#) is a modified version of [Nordic's nrfutil \(\)](#), which is used to flash boards using the built in serial bootloader. It is originally written for python2, but have been migrated to python3 and renamed to adafruit-nrfutil since BSP version 0.8.5.

This step is only required on Linux, pre-built binaries of adafruit-nrfutil for Windows and MacOS are already included in the BSP. That should work out of the box for most setups.

Install python3 if it is not installed in your system already

```
$ sudo apt-get install python3
```

Then run the following command to install the tool from PyPi

```
$ pip3 install --user adafruit-nrfutil
```

Add pip3 installation dir to your PATH if it is not added already. Make sure adafruit-nrfutil can be executed in terminal by running

```
$ adafruit-nrfutil version  
adafruit-nrfutil version 0.5.3.post12
```

## 3. Update the bootloader (nRF52832 ONLY)

To keep up with Nordic's SoftDevice advances, you will likely need to update your bootloader if you are using the original nRF52832 based Bluefruit nRF52 Feather boards.

Follow this link for instructions on how to do that

This step ISN'T required for the newer nRF52840 Feather Express, which has a different bootloader entirely!

[Update the nRF52832 Bootloader](#)

# Advanced Option: Manually Install the BSP via 'git'

If you wish to do any development against the core codebase (generate pull requests, etc.), you can also optionally install the Adafruit nRF52 BSP manually using 'git', as described below:

## Adafruit nRF52 BSP via git (for core development and PRs only)

1. Install BSP via Board Manager as above to install compiler & tools.
2. Delete the core folder nrf52 installed by Board Manager in Arduino15, depending on your OS. It could be  
macOS: `~/Library/Arduino15/packages/adafruit/hardware/nrf52`  
Linux: `~/Library/Arduino15/packages/adafruit/hardware/nrf52`  
Windows: `%APPDATA%\Local\Arduino15\packages\adafruit\hardware\nrf52`
3. Go to the sketchbook folder on your command line, which should be one of the following:  
macOS: `~/Documents/Arduino`  
Linux: `~/Arduino`  
Windows: `~/Documents/Arduino`
4. Create a folder named `hardware/Adafruit`, if it does not exist, and change directories into it.
5. Clone the [Adafruit\\_nRF52\\_Arduino \(\)](#) repo in the folder described in step 2:  
`git clone --recurse-submodules git@github.com:adafruit/Adafruit_nRF52_Arduino.git`
6. This should result in a final folder name like `~/Documents/Arduino/hardware/Adafruit/Adafruit_nRF52_Arduino` (macOS).
7. Restart the Arduino IDE

---

## Arduino BLE Examples

There are numerous examples available for the Bluefruit nRF52/nRF52840 Feathers in the Examples menu of the nRF52 BSP, and these are always up to date. Your first stop looking for example code should be there:

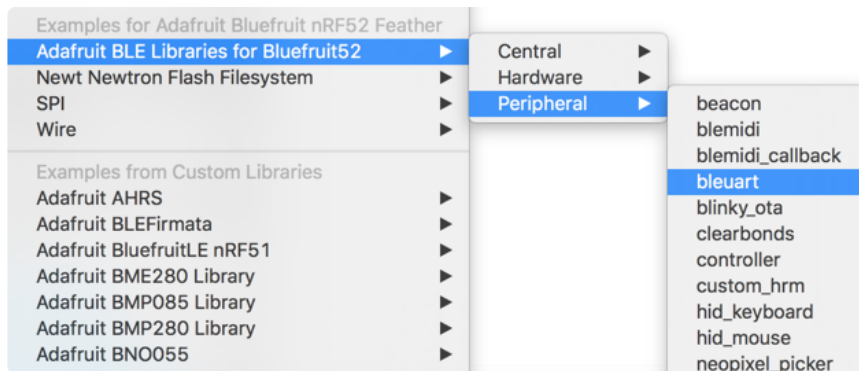

## Example Source Code

The latest example source code is always available and visible on Github, and the public git repository should be considered the definitive source of example code for this board.

Click here to browse the example source code on Github

## Documented Examples

To help explain some common use cases for the nRF52 BLE API, feel free to consult the example documentation in this section of the learning guide:

- Advertising: Beacon - Shows how to use the BLEBeacon helper class to configure your Bluefruit nRF52 Feather as a beacon
- BLE UART: Controller - Shows how to use the Controller utility in our Bluefruit LE Connect apps to send basic data between your peripheral and your phone or tablet.
- Custom: HRM - Shows how to defined and work with a custom GATT Service and Characteristic, using the officially adopted Heart Rate Monitor (HRM) service as an example.
- BLE Pin I/O (StandardFirmataBLE) Shows how to control Pin I/O of nRF52 with Firmata protocol

For more information on the Arduino nRF52 API, check out [this page](#) ().

---

# Advertising: Beacon

This example shows how you can use the BLEBeacon helper class and advertising API to configure your Bluefruit nRF52 board as a 'Beacon'.

## Complete Code

```
/******  
This is an example for our nRF52 based Bluefruit LE modules  
  
Pick one up today in the adafruit shop!  
  
Adafruit invests time and resources providing this open source code,  
please support Adafruit and open-source hardware by purchasing  
products from Adafruit!  
  
MIT license, check LICENSE for more information  
All text above, and the splash screen below must be included in  
any redistribution  
*****/  
#include <bluefruit.h>  
  
// Beacon uses the Manufacturer Specific Data field in the advertising  
// packet, which means you must provide a valid Manufacturer ID. Update  
// the field below to an appropriate value. For a list of valid IDs see:  
// https://www.bluetooth.com/specifications/assigned-numbers/company-identifiers  
// 0x004C is Apple  
// 0x0822 is Adafruit  
// 0x0059 is Nordic  
#define MANUFACTURER_ID 0x0059  
  
// "nRF Connect" app can be used to detect beacon  
uint8_t beaconUuid[16] =  
{  
  0x01, 0x12, 0x23, 0x34, 0x45, 0x56, 0x67, 0x78,  
  0x89, 0x9a, 0xab, 0xbc, 0xcd, 0xde, 0xef, 0xf0  
};  
  
// A valid Beacon packet consists of the following information:  
// UUID, Major, Minor, RSSI @ 1M  
BLEBeacon beacon(beaconUuid, 0x0102, 0x0304, -54);  
  
void setup()  
{  
  Serial.begin(115200);  
  
  // Uncomment to blocking wait for Serial connection  
  // while ( !Serial ) delay(10);  
  
  Serial.println("Bluefruit52 Beacon Example");  
  Serial.println("-----\n");  
  
  Bluefruit.begin();  
  
  // off Blue LED for lowest power consumption  
  Bluefruit.autoConnLed(false);  
  Bluefruit.setTxPower(0); // Check bluefruit.h for supported values  
  
  // Manufacturer ID is required for Manufacturer Specific Data  
  beacon.setManufacturer(MANUFACTURER_ID);  
}
```

```

// Setup the advertising packet
startAdv();

Serial.println("Broadcasting beacon, open your beacon app to test");

// Suspend Loop() to save power, since we didn't have any code there
suspendLoop();
}

void startAdv(void)
{
  // Advertising packet
  // Set the beacon payload using the BLEBeacon class populated
  // earlier in this example
  Bluefruit.Advertising.setBeacon(beacon);

  // Secondary Scan Response packet (optional)
  // Since there is no room for 'Name' in Advertising packet
  Bluefruit.ScanResponse.addName();

  /* Start Advertising
   * - Enable auto advertising if disconnected
   * - Timeout for fast mode is 30 seconds
   * - Start(timeout) with timeout = 0 will advertise forever (until connected)
   *
   * Apple Beacon specs
   * - Type: Non connectable, undirected
   * - Fixed interval: 100 ms -> fast = slow = 100 ms
   */
  //Bluefruit.Advertising.setType(BLE_GAP_ADV_TYPE_ADV_NONCONN_IND);
  Bluefruit.Advertising.restartOnDisconnect(true);
  Bluefruit.Advertising.setInterval(160, 160); // in unit of 0.625 ms
  Bluefruit.Advertising.setFastTimeout(30); // number of seconds in fast mode
  Bluefruit.Advertising.start(0); // 0 = Don't stop advertising
  after n seconds
}

void loop()
{
  // loop is already suspended, CPU will not run loop() at all
}

```

## Output

You can use the nRF Beacons application from Nordic Semiconductors to test this sketch:

- [nRF Beacons for iOS \(\)](#)
- [nRF Beacons for Android \(\)](#)

Make sure that you set the UUID, Major and Minor values to match the sketch above, and then run the sketch at the same time as the nRF Beacons application.

With the default setup you should see a Mona Lisa icon when the beacon is detected. If you don't see this, double check the UUID, Major and Minor values to be sure they match exactly.

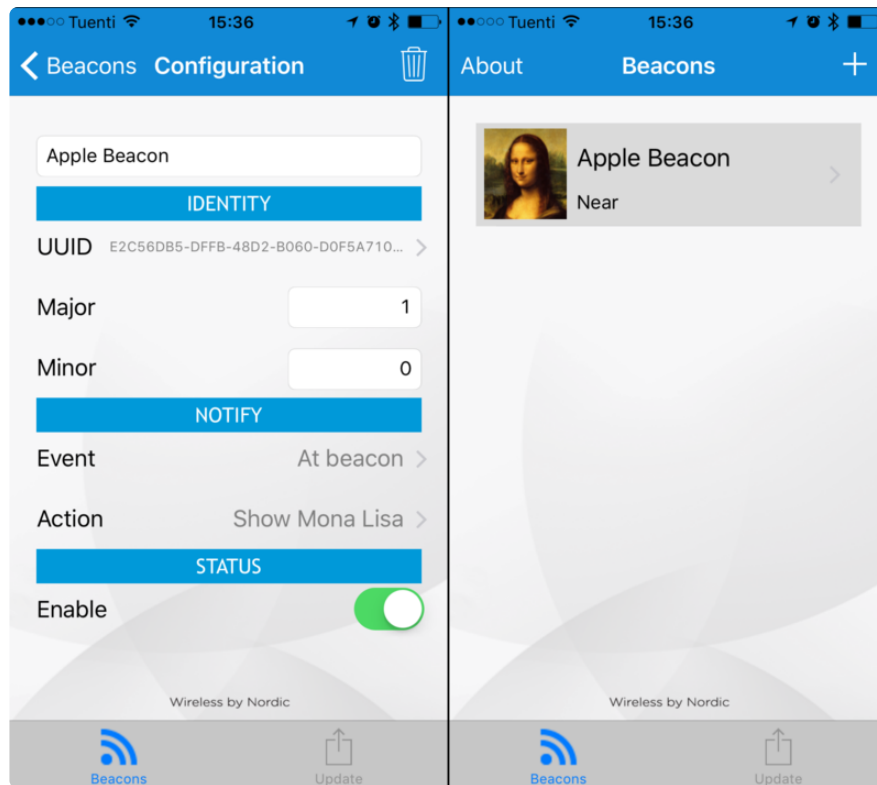

---

## BLE UART: Controller

This examples shows you you can use the BLEUart helper class and the Bluefruit LE Connect applications to send based keypad and sensor data to your nRF52.

## Setup

In order to use this sketch, you will need to open Bluefruit LE Connect on your mobile device using our free [iOS \(\)](#), [Android \(\)](#) or [OS X \(\)](#) applications.

- Load the [Controller example sketch \(\)](#) in the Arduino IDE
- Compile the sketch and flash it to your nRF52 based Feather
- Once you are done uploading, open the Serial Monitor (Tools > Serial Monitor)
- Open the Bluefruit LE Connect application on your mobile device
- Connect to the appropriate target (probably 'Bluefruit52')
- Once connected switch to the Controller application inside the app
- Enable an appropriate control surface. The Color Picker control surface is shown below, for example (screen shot taken from the iOS application):

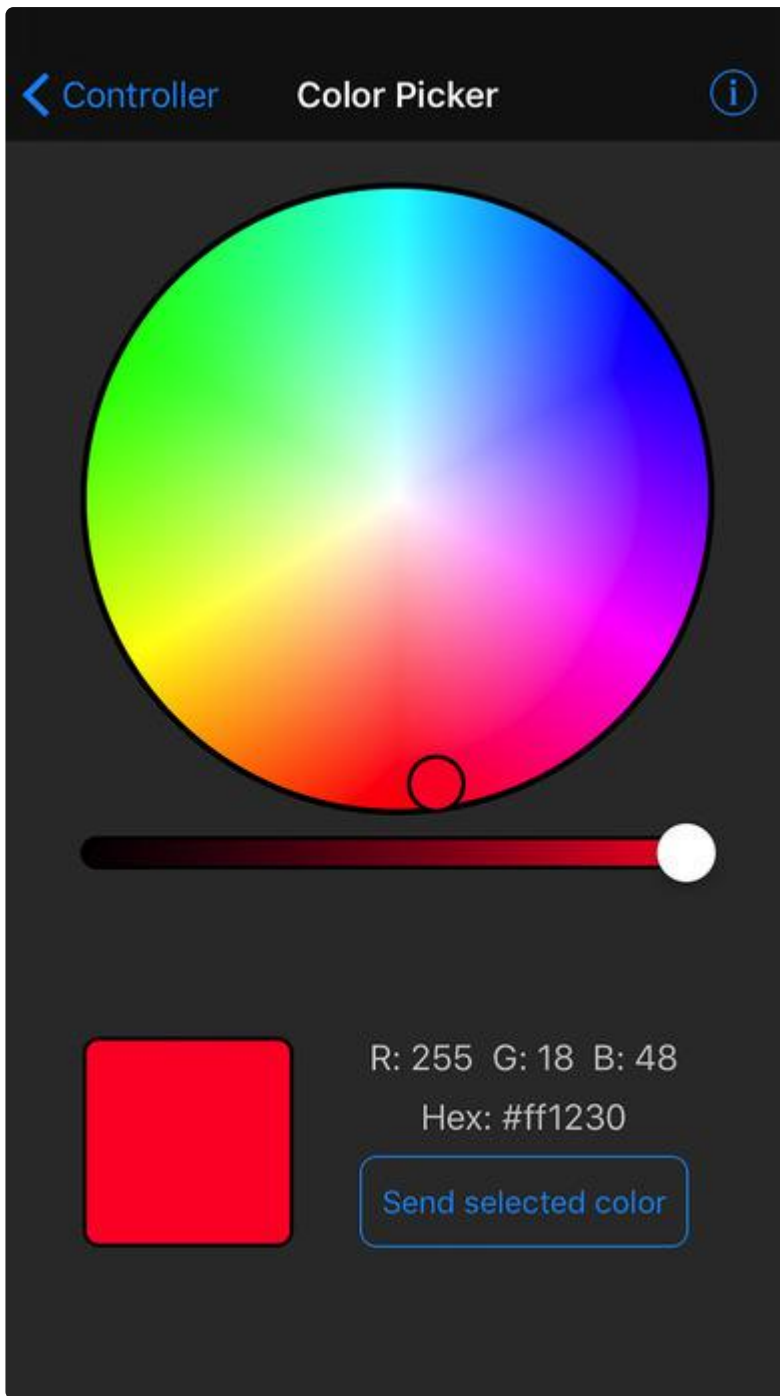

As you change the color (or as other data becomes available) you should receive the data on the nRF52, and see it in the Serial Monitor output:

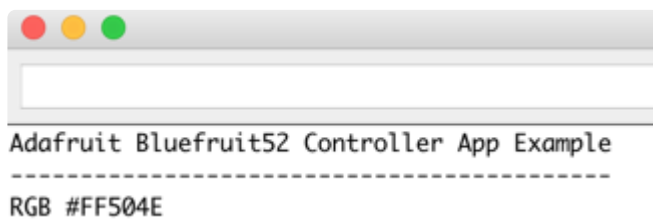

# Complete Code

```
/******  
This is an example for our nRF52 based Bluefruit LE modules  
  
Pick one up today in the adafruit shop!  
  
Adafruit invests time and resources providing this open source code,  
please support Adafruit and open-source hardware by purchasing  
products from Adafruit!  
  
MIT license, check LICENSE for more information  
All text above, and the splash screen below must be included in  
any redistribution  
*****/  
  
#include <bluefruit.h>  
  
// OTA DFU service  
BLEDFU bleDFU;  
  
// Uart over BLE service  
BLEUART bleUART;  
  
// Function prototypes for packetparser.cpp  
uint8_t readPacket (BLEUART *ble_uart, uint16_t timeout);  
float   parseFloat (uint8_t *buffer);  
void    printHex   (const uint8_t * data, const uint32_t numBytes);  
  
// Packet buffer  
extern uint8_t packetbuffer[];  
  
void setup(void)  
{  
  Serial.begin(115200);  
  while ( !Serial ) delay(10); // for nrf52840 with native usb  
  
  Serial.println(F("Adafruit Bluefruit52 Controller App Example"));  
  Serial.println(F("-----"));  
  
  Bluefruit.begin();  
  Bluefruit.setTxPower(4); // Check bluefruit.h for supported values  
  
  // To be consistent OTA DFU should be added first if it exists  
  bleDFU.begin();  
  
  // Configure and start the BLE Uart service  
  bleUART.begin();  
  
  // Set up and start advertising  
  startAdv();  
  
  Serial.println(F("Please use Adafruit Bluefruit LE app to connect in Controller  
mode"));  
  Serial.println(F("Then activate/use the sensors, color picker, game controller,  
etc!"));  
  Serial.println();  
}  
  
void startAdv(void)  
{  
  // Advertising packet  
  Bluefruit.Advertising.addFlags(BLE_GAP_ADV_FLAGS_LE_ONLY_GENERAL_DISC_MODE);
```

```

Bluefruit.Advertising.addTxPower();

// Include the BLE UART (AKA 'NUS') 128-bit UUID
Bluefruit.Advertising.addService(bleuart);

// Secondary Scan Response packet (optional)
// Since there is no room for 'Name' in Advertising packet
Bluefruit.ScanResponse.addName();

/* Start Advertising
 * - Enable auto advertising if disconnected
 * - Interval: fast mode = 20 ms, slow mode = 152.5 ms
 * - Timeout for fast mode is 30 seconds
 * - Start(timeout) with timeout = 0 will advertise forever (until connected)
 *
 * For recommended advertising interval
 * https://developer.apple.com/library/content/qa/qa1931/_index.html
 */
Bluefruit.Advertising.restartOnDisconnect(true);
Bluefruit.Advertising.setInterval(32, 244); // in unit of 0.625 ms
Bluefruit.Advertising.setFastTimeout(30); // number of seconds in fast mode
Bluefruit.Advertising.start(0); // 0 = Don't stop advertising
after n seconds
}

/*****
/*!
 @brief Constantly poll for new command or response data
*/
*****/
void loop(void)
{
  // Wait for new data to arrive
  uint8_t len = readPacket(&bleuart, 500);
  if (len == 0) return;

  // Got a packet!
  // printHex(packetbuffer, len);

  // Color
  if (packetbuffer[1] == 'C') {
    uint8_t red = packetbuffer[2];
    uint8_t green = packetbuffer[3];
    uint8_t blue = packetbuffer[4];
    Serial.print("RGB #");
    if (red < 0x10) Serial.print("0");
    Serial.print(red, HEX);
    if (green < 0x10) Serial.print("0");
    Serial.print(green, HEX);
    if (blue < 0x10) Serial.print("0");
    Serial.println(blue, HEX);
  }

  // Buttons
  if (packetbuffer[1] == 'B') {
    uint8_t buttnum = packetbuffer[2] - '0';
    boolean pressed = packetbuffer[3] - '0';
    Serial.print("Button "); Serial.print(buttnum);
    if (pressed) {
      Serial.println(" pressed");
    } else {
      Serial.println(" released");
    }
  }

  // GPS Location
  if (packetbuffer[1] == 'L') {
    float lat, lon, alt;
    lat = parseFloat(packetbuffer+2);

```

```

lon = parsefloat(packetbuffer+6);
alt = parsefloat(packetbuffer+10);
Serial.print("GPS Location\t");
Serial.print("Lat: "); Serial.print(lat, 4); // 4 digits of precision!
Serial.print('\t');
Serial.print("Lon: "); Serial.print(lon, 4); // 4 digits of precision!
Serial.print('\t');
Serial.print(alt, 4); Serial.println(" meters");
}

// Accelerometer
if (packetbuffer[1] == 'A') {
  float x, y, z;
  x = parsefloat(packetbuffer+2);
  y = parsefloat(packetbuffer+6);
  z = parsefloat(packetbuffer+10);
  Serial.print("Acce\t");
  Serial.print(x); Serial.print('\t');
  Serial.print(y); Serial.print('\t');
  Serial.print(z); Serial.println();
}

// Magnetometer
if (packetbuffer[1] == 'M') {
  float x, y, z;
  x = parsefloat(packetbuffer+2);
  y = parsefloat(packetbuffer+6);
  z = parsefloat(packetbuffer+10);
  Serial.print("Mag\t");
  Serial.print(x); Serial.print('\t');
  Serial.print(y); Serial.print('\t');
  Serial.print(z); Serial.println();
}

// Gyroscope
if (packetbuffer[1] == 'G') {
  float x, y, z;
  x = parsefloat(packetbuffer+2);
  y = parsefloat(packetbuffer+6);
  z = parsefloat(packetbuffer+10);
  Serial.print("Gyro\t");
  Serial.print(x); Serial.print('\t');
  Serial.print(y); Serial.print('\t');
  Serial.print(z); Serial.println();
}

// Quaternions
if (packetbuffer[1] == 'Q') {
  float x, y, z, w;
  x = parsefloat(packetbuffer+2);
  y = parsefloat(packetbuffer+6);
  z = parsefloat(packetbuffer+10);
  w = parsefloat(packetbuffer+14);
  Serial.print("Quat\t");
  Serial.print(x); Serial.print('\t');
  Serial.print(y); Serial.print('\t');
  Serial.print(z); Serial.print('\t');
  Serial.print(w); Serial.println();
}
}

```

You will also need the following helper class in a file called packetParser.cpp:

```

#include <string.h>
#include <Arduino.h>
#include <bluefruit.h>

```

```

#define PACKET_ACC_LEN                (15)
#define PACKET_GYRO_LEN               (15)
#define PACKET_MAG_LEN                (15)
#define PACKET_QUAT_LEN               (19)
#define PACKET_BUTTON_LEN             (5)
#define PACKET_COLOR_LEN              (6)
#define PACKET_LOCATION_LEN           (15)

// READ_BUFSIZE                      Size of the read buffer for incoming packets
#define READ_BUFSIZE                   (20)

/* Buffer to hold incoming characters */
uint8_t packetbuffer[READ_BUFSIZE+1];

/*****
/*!
 * @brief Casts the four bytes at the specified address to a float
 */
/*****
float parseFloat(uint8_t *buffer)
{
    float f;
    memcpy(&f, buffer, 4);
    return f;
}

/*****
/*!
 * @brief Prints a hexadecimal value in plain characters
 * @param data Pointer to the byte data
 * @param numBytes Data length in bytes
 */
/*****
void printHex(const uint8_t * data, const uint32_t numBytes)
{
    uint32_t szPos;
    for (szPos=0; szPos < numBytes; szPos++)
    {
        Serial.print(F("0x"));
        // Append leading 0 for small values
        if (data[szPos] <= 0xF)
        {
            Serial.print(F("0"));
            Serial.print(data[szPos] & 0xf, HEX);
        }
        else
        {
            Serial.print(data[szPos]& 0xff, HEX);
        }
        // Add a trailing space if appropriate
        if ((numBytes > 1) && (szPos != numBytes - 1))
        {
            Serial.print(F(" "));
        }
    }
    Serial.println();
}

/*****
/*!
 * @brief Waits for incoming data and parses it
 */
/*****
uint8_t readPacket(BLEUart *ble_uart, uint16_t timeout)
{
    uint16_t origtimeout = timeout, replyidx = 0;

```

```

memset(packetbuffer, 0, READ_BUFSIZE);

while (timeout--) {
  if (replyidx >= 20) break;
  if ((packetbuffer[1] == 'A') && (replyidx == PACKET_ACC_LEN))
    break;
  if ((packetbuffer[1] == 'G') && (replyidx == PACKET_GYRO_LEN))
    break;
  if ((packetbuffer[1] == 'M') && (replyidx == PACKET_MAG_LEN))
    break;
  if ((packetbuffer[1] == 'Q') && (replyidx == PACKET_QUAT_LEN))
    break;
  if ((packetbuffer[1] == 'B') && (replyidx == PACKET_BUTTON_LEN))
    break;
  if ((packetbuffer[1] == 'C') && (replyidx == PACKET_COLOR_LEN))
    break;
  if ((packetbuffer[1] == 'L') && (replyidx == PACKET_LOCATION_LEN))
    break;

  while (ble_uart->available()) {
    char c = ble_uart->read();
    if (c == '!') {
      replyidx = 0;
    }
    packetbuffer[replyidx] = c;
    replyidx++;
    timeout = origtimeout;
  }

  if (timeout == 0) break;
  delay(1);
}

packetbuffer[replyidx] = 0; // null term

if (!replyidx) // no data or timeout
  return 0;
if (packetbuffer[0] != '!') // doesn't start with '!' packet beginning
  return 0;

// check checksum!
uint8_t xsum = 0;
uint8_t checksum = packetbuffer[replyidx-1];

for (uint8_t i=0; i<replyidx-1; i++) {
  xsum += packetbuffer[i];
}
xsum = ~xsum;

// Throw an error message if the checksum's don't match
if (xsum != checksum)
{
  Serial.print("Checksum mismatch in packet : ");
  printHex(packetbuffer, replyidx+1);
  return 0;
}

// checksum passed!
return replyidx;
}

```

---

## Custom: HRM

The `BLEService` and `BLECharacteristic` classes can be used to implement any custom or officially adopted BLE service or characteristic using a set of basic properties and callback handlers.

The example below shows how to use these classes to implement the [Heart Rate Monitor \(\)](#) service, as defined by the Bluetooth SIG.

## HRM Service Definition

UUID: [0x180D \(\)](#)

Characteristic Name	UUID	Requirement	Properties
<a href="#">Heart Rate Measurement</a>	0x2A37	Mandatory	Notify
<a href="#">Body Sensor Location</a>	0x2A38	Optional	Read
<a href="#">Heart Rate Control Point</a>	0x2A39	Conditional	Write

Only the first characteristic is mandatory, but we will also implement the optional Body Sensor Location characteristic. Heart Rate Control Point won't be used in this example to keep things simple.

## Implementing the HRM Service and Characteristics

The core service and the first two characteristics can be implemented with the following code:

First, define the `BLEService` and `BLECharacteristic` variables that will be used in your project:

```
/* HRM Service Definitions
 * Heart Rate Monitor Service: 0x180D
 * Heart Rate Measurement Char: 0x2A37
 * Body Sensor Location Char: 0x2A38
 */
BLEService hrms = BLEService(UUID16_SVC_HEART_RATE);
BLECharacteristic hrmc = BLECharacteristic(UUID16_CHR_HEART_RATE_MEASUREMENT);
BLECharacteristic bslc = BLECharacteristic(UUID16_CHR_BODY_SENSOR_LOCATION);
```

Then you need to 'populate' those variables with appropriate values. For simplicity sake, you can define a custom function for your service where all of the code is placed, and then just call this function once in the 'setup' function:

```

void setupHRM(void)
{
  // Configure the Heart Rate Monitor service
  // See: https://www.bluetooth.com/specifications/gatt/viewer?
  attributeXmlFile=org.bluetooth.service.heart_rate.xml
  // Supported Characteristics:
  // Name                                UUID      Requirement Properties
  // -----
  // Heart Rate Measurement              0x2A37    Mandatory    Notify
  // Body Sensor Location                 0x2A38    Optional     Read
  // Heart Rate Control Point             0x2A39    Conditional  Write        &lt;!-- Not used
here
  hrms.begin();

  // Note: You must call .begin() on the BLEService before calling .begin() on
  // any characteristic(s) within that service definition.. Calling .begin() on
  // a BLECharacteristic will cause it to be added to the last BLEService that
  // was 'begin()'ed!

  // Configure the Heart Rate Measurement characteristic
  // See: https://www.bluetooth.com/specifications/gatt/viewer?
  attributeXmlFile=org.bluetooth.characteristic.heart_rate_measurement.xml
  // Permission = Notify
  // Min Len    = 1
  // Max Len    = 8
  //   B0       = UINT8 - Flag (MANDATORY)
  //   b5:7     = Reserved
  //   b4       = RR-Internal (0 = Not present, 1 = Present)
  //   b3       = Energy expended status (0 = Not present, 1 = Present)
  //   b1:2     = Sensor contact status (0+1 = Not supported, 2 = Supported but
contact not detected, 3 = Supported and detected)
  //   b0       = Value format (0 = UINT8, 1 = UINT16)
  //   B1       = UINT8 - 8-bit heart rate measurement value in BPM
  //   B2:3     = UINT16 - 16-bit heart rate measurement value in BPM
  //   B4:5     = UINT16 - Energy expended in joules
  //   B6:7     = UINT16 - RR Internal (1/1024 second resolution)
  hrmc.setProperties(CHR_PROPS_NOTIFY);
  hrmc.setPermission(SECMODE_OPEN, SECMODE_NO_ACCESS);
  hrmc.setFixedLen(2);
  hrmc.setCccdWriteCallback(cccd_callback); // Optionally capture CCCD updates
  hrmc.begin();
  uint8_t hrmdata[2] = { 0b00000110, 0x40 }; // Set the characteristic to use 8-bit
values, with the sensor connected and detected
  hrmc.notify(hrmdata, 2); // Use .notify instead of .write!

  // Configure the Body Sensor Location characteristic
  // See: https://www.bluetooth.com/specifications/gatt/viewer?
  attributeXmlFile=org.bluetooth.characteristic.body_sensor_location.xml
  // Permission = Read
  // Min Len    = 1
  // Max Len    = 1
  //   B0       = UINT8 - Body Sensor Location
  //   0        = Other
  //   1        = Chest
  //   2        = Wrist
  //   3        = Finger
  //   4        = Hand
  //   5        = Ear Lobe
  //   6        = Foot
  //   7:255   = Reserved
  bscl.setProperties(CHR_PROPS_READ);
  bscl.setPermission(SECMODE_OPEN, SECMODE_NO_ACCESS);

```

```
bslc.setFixedLen(1);
bslc.begin();
bslc.write8(2);    // Set the characteristic to 'Wrist' (2)
}
```

## Service + Characteristic Setup Code Analysis

1. The first thing to do is to call `.begin()` on the `BLEService` (`hrms` above). Since the UUID is set in the object declaration at the top of the sketch, there is normally nothing else to do with the `BLEService` instance.

You MUST call `.begin()` on the `BLEService` before adding any `BLECharacteristics`. Any `BLECharacteristic` will automatically be added to the last `BLEService` that was `.begin()`'ed!

2. Next, you can configure the Heart Rate Measurement characteristic (`hrmc` above). The values that you set for this will depend on the characteristic definition, but for convenience sake we've documented the key information in the comments in the code above.

- `hrmc.setProperties(CHR_PROPS_NOTIFY);` - This sets the `PROPERTIES` value for the characteristic, which determines how the characteristic can be accessed. In this case, the Bluetooth SIG has defined the characteristic as `Notify`, which means that the peripheral will receive a request ('notification') from the Central when the Central wants to receive data using this characteristic.
- `hrmc.setPermission(SECMODE_OPEN, SECMODE_NO_ACCESS);` - This sets the security for the characteristic, and should normally be set to the values used in this example.
- `hrmc.setFixedLen(2);` - This tells the Bluetooth stack how many bytes the characteristic contains (normally a value between 1 and 20). In this case, we will use a fixed size of two bytes, so we call `.setFixedLen`. If the characteristic has a variable length, you would need to set the max size via `.setMaxLen`.
- `hrmc.setCccdWriteCallback(cccd_callback);` - This optional code sets the callback that will be fired when the CCCD record is updated by the central. This is relevant because the characteristic is setup with the `NOTIFY` property. When the Central sets to 'Notify' bit, it will write to the CCCD record, and you can capture this write even in the CCCD callback and turn the sensor on, for example, allowing you to save power by only turning the sensor on (and back off) when it is or isn't actually being used. For the implementation of the CCCD callback handler, see the full sample code at the bottom of this page.

- `hrmc.begin();` Once all of the properties have been set, you must call `.begin()` which will add the characteristic definition to the last BLEService that was `.begin()`'ed.

3. Optionally set an initial value for the characteristic(s), such as the following code that populates 'hrmc' with a correct values, indicating that we are providing 8-bit heart rate monitor values, that the Body Sensor Location characteristic is present, and setting the first heart rate value to 0x04:

Note that we use `.notify()` in the example above instead of `.write()`, since this characteristic is setup with the NOTIFY property which needs to be handled in a slightly different manner than other characteristics.

```
// Set the characteristic to use 8-bit values, with the sensor connected and
detected
uint8_t hrmdata[2] = { 0b00000110, 0x40 };

// Use .notify instead of .write!
hrmc.notify(hrmdata, 2);
```

The CCCD callback handler has the following signature:

```
void cccd_callback(uint16_t conn_hdl, BLECharacteristic* chr, uint16_t cccd_value)
{
    // Display the raw request packet
    Serial.print("CCCD Updated: ");
    //Serial.printBuffer(request->data, request->len);
    Serial.print(cccd_value);
    Serial.println("");

    // Check the characteristic this CCCD update is associated with in case
    // this handler is used for multiple CCCD records.
    if (chr->uuid == hmc.uuid) {
        if (chr->indicateEnabled(conn_hdl)) {
            Serial.println("Temperature Measurement 'Indicate' enabled");
        } else {
            Serial.println("Temperature Measurement 'Indicate' disabled");
        }
    }
}
```

4. Repeat the same procedure for any other BLECharacteristics in your service.

## Full Sample Code

The full sample code for this example can be seen below:

```
/******
This is an example for our nRF52 based Bluefruit LE modules

Pick one up today in the adafruit shop!
******/
```

Adafruit invests time and resources providing this open source code, please support Adafruit and open-source hardware by purchasing products from Adafruit!

MIT license, check LICENSE for more information  
All text above, and the splash screen below must be included in any redistribution

```
*****  
#include <bluefruit.h>  
  
/* HRM Service Definitions  
 * Heart Rate Monitor Service: 0x180D  
 * Heart Rate Measurement Char: 0x2A37  
 * Body Sensor Location Char: 0x2A38  
 */  
BLEService hrms = BLEService(UUID16_SVC_HEART_RATE);  
BLECharacteristic hrmc = BLECharacteristic(UUID16_CHR_HEART_RATE_MEASUREMENT);  
BLECharacteristic bslc = BLECharacteristic(UUID16_CHR_BODY_SENSOR_LOCATION);  
  
BLEDis bledis; // DIS (Device Information Service) helper class instance  
BLEBas blebas; // BAS (Battery Service) helper class instance  
  
uint8_t bps = 0;  
  
void setup()  
{  
  Serial.begin(115200);  
  while ( !Serial ) delay(10); // for nrf52840 with native usb  
  
  Serial.println("Bluefruit52 HRM Example");  
  Serial.println("-----\n");  
  
  // Initialise the Bluefruit module  
  Serial.println("Initialise the Bluefruit nRF52 module");  
  Bluefruit.begin();  
  
  // Set the connect/disconnect callback handlers  
  Bluefruit.Periph.setConnectCallback(connect_callback);  
  Bluefruit.Periph.setDisconnectCallback(disconnect_callback);  
  
  // Configure and Start the Device Information Service  
  Serial.println("Configuring the Device Information Service");  
  bledis.setManufacturer("Adafruit Industries");  
  bledis.setModel("Bluefruit Feather52");  
  bledis.begin();  
  
  // Start the BLE Battery Service and set it to 100%  
  Serial.println("Configuring the Battery Service");  
  blebas.begin();  
  blebas.write(100);  
  
  // Setup the Heart Rate Monitor service using  
  // BLEService and BLECharacteristic classes  
  Serial.println("Configuring the Heart Rate Monitor Service");  
  setupHRM();  
  
  // Setup the advertising packet(s)  
  Serial.println("Setting up the advertising payload(s)");  
  startAdv();  
  
  Serial.println("Ready Player One!!!");  
  Serial.println("\nAdvertising");  
}  
  
void startAdv(void)  
{  
  // Advertising packet  
  Bluefruit.Advertising.addFlags(BLE_GAP_ADV_FLAGS_LE_ONLY_GENERAL_DISC_MODE);
```

```

Bluefruit.Advertising.addTxPower();

// Include HRM Service UUID
Bluefruit.Advertising.addService(hrms);

// Include Name
Bluefruit.Advertising.addName();

/* Start Advertising
 * - Enable auto advertising if disconnected
 * - Interval: fast mode = 20 ms, slow mode = 152.5 ms
 * - Timeout for fast mode is 30 seconds
 * - Start(timeout) with timeout = 0 will advertise forever (until connected)
 *
 * For recommended advertising interval
 * https://developer.apple.com/library/content/qa/qa1931/_index.html
 */
Bluefruit.Advertising.restartOnDisconnect(true);
Bluefruit.Advertising.setInterval(32, 244); // in unit of 0.625 ms
Bluefruit.Advertising.setFastTimeout(30); // number of seconds in fast mode
Bluefruit.Advertising.start(0); // 0 = Don't stop advertising
after n seconds
}

void setupHRM(void)
{
// Configure the Heart Rate Monitor service
// See: https://www.bluetooth.com/specifications/gatt/viewer?
attributeXmlFile=org.bluetooth.service.heart_rate.xml
// Supported Characteristics:
// Name UUID Requirement Properties
// -----
// Heart Rate Measurement 0x2A37 Mandatory Notify
// Body Sensor Location 0x2A38 Optional Read
// Heart Rate Control Point 0x2A39 Conditional Write <-- Not used here
hrms.begin();

// Note: You must call .begin() on the BLEService before calling .begin() on
// any characteristic(s) within that service definition.. Calling .begin() on
// a BLECharacteristic will cause it to be added to the last BLEService that
// was 'begin()'ed!

// Configure the Heart Rate Measurement characteristic
// See: https://www.bluetooth.com/specifications/gatt/viewer?
attributeXmlFile=org.bluetooth.characteristic.heart_rate_measurement.xml
// Properties = Notify
// Min Len = 1
// Max Len = 8
// B0 = UINT8 - Flag (MANDATORY)
// b5:7 = Reserved
// b4 = RR-Internal (0 = Not present, 1 = Present)
// b3 = Energy expended status (0 = Not present, 1 = Present)
// b1:2 = Sensor contact status (0+1 = Not supported, 2 = Supported but
contact not detected, 3 = Supported and detected)
// b0 = Value format (0 = UINT8, 1 = UINT16)
// B1 = UINT8 - 8-bit heart rate measurement value in BPM
// B2:3 = UINT16 - 16-bit heart rate measurement value in BPM
// B4:5 = UINT16 - Energy expended in joules
// B6:7 = UINT16 - RR Internal (1/1024 second resolution)
hrmc.setProperties(CHR_PROPS_NOTIFY);
hrmc.setPermission(SECMODE_OPEN, SECMODE_NO_ACCESS);
hrmc.setFixedLen(2);
hrmc.setCccdWriteCallback(cccd_callback); // Optionally capture CCCD updates
hrmc.begin();
uint8_t hrmdata[2] = { 0b00000110, 0x40 }; // Set the characteristic to use 8-bit
values, with the sensor connected and detected
hrmc.write(hrmdata, 2);

// Configure the Body Sensor Location characteristic

```

```

    // See: https://www.bluetooth.com/specifications/gatt/viewer?
attributeXmlFile=org.bluetooth.characteristic.body_sensor_location.xml
    // Properties = Read
    // Min Len     = 1
    // Max Len     = 1
    //   B0       = UINT8 - Body Sensor Location
    //   0        = Other
    //   1        = Chest
    //   2        = Wrist
    //   3        = Finger
    //   4        = Hand
    //   5        = Ear Lobe
    //   6        = Foot
    //   7:255    = Reserved
    bslc.setProperties(CHR_PROPS_READ);
    bslc.setPermission(SECMODE_OPEN, SECMODE_NO_ACCESS);
    bslc.setFixedLen(1);
    bslc.begin();
    bslc.write8(2);    // Set the characteristic to 'Wrist' (2)
}

void connect_callback(uint16_t conn_handle)
{
    // Get the reference to current connection
    BLEConnection* connection = Bluefruit.Connection(conn_handle);

    char central_name[32] = { 0 };
    connection->getPeerName(central_name, sizeof(central_name));

    Serial.print("Connected to ");
    Serial.println(central_name);
}

/**
 * Callback invoked when a connection is dropped
 * @param conn_handle connection where this event happens
 * @param reason is a BLE_HCI_STATUS_CODE which can be found in ble_hci.h
 */
void disconnect_callback(uint16_t conn_handle, uint8_t reason)
{
    (void) conn_handle;
    (void) reason;

    Serial.print("Disconnected, reason = 0x"); Serial.println(reason, HEX);
    Serial.println("Advertising!");
}

void cccd_callback(uint16_t conn_hdl, BLECharacteristic* chr, uint16_t cccd_value)
{
    // Display the raw request packet
    Serial.print("CCCD Updated: ");
    //Serial.printBuffer(request->data, request->len);
    Serial.print(cccd_value);
    Serial.println("");

    // Check the characteristic this CCCD update is associated with in case
    // this handler is used for multiple CCCD records.
    if (chr->uuid == hrmc.uuid) {
        if (chr->notifyEnabled(conn_hdl)) {
            Serial.println("Heart Rate Measurement 'Notify' enabled");
        } else {
            Serial.println("Heart Rate Measurement 'Notify' disabled");
        }
    }
}

void loop()
{
    digitalToggle(LED_RED);
}

```

```

if ( Bluefruit.connected() ) {
    uint8_t hrmdata[2] = { 0b00000110, bps++ };           // Sensor connected,
    increment_BPS value

    // Note: We use .notify instead of .write!
    // If it is connected but CCCD is not enabled
    // The characteristic's value is still updated although notification is not sent
    if ( hrmc.notify(hrmdata, sizeof(hrmdata)) ){
        Serial.print("Heart Rate Measurement updated to: "); Serial.println(bps);
    }else{
        Serial.println("ERROR: Notify not set in the CCCD or not connected!");
    }
}

// Only send update once per second
delay(1000);
}

```

## Bluefruit LE Connect



**Adafruit Bluefruit LE Connect** 4.1  
 Adafruit Industries  
 4.1, 8 Ratings  
 Free

Screenshots [iPhone](#) [iPad](#) [Apple Watch](#)

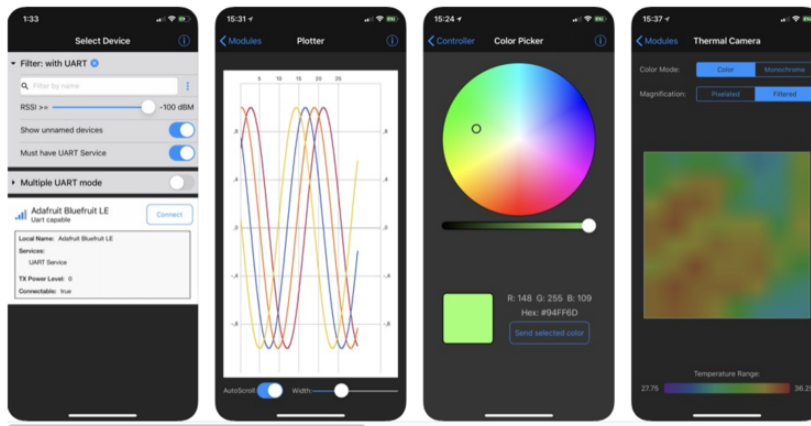

The Bluefruit LE Connect app provides iOS devices with a variety of tools to communicate with Bluefruit LE devices, such as the Circuit Playground Bluefruit! These tools cover basic communication and info reporting as well as more project specific uses such as remote button control and a NeoPixel color picker.

The iOS app is a [free download from Apple's App Store](#) (). As of this writing, it requires iOS 11.3 or later and works on the iPhone, iPad, and iPod Touch.

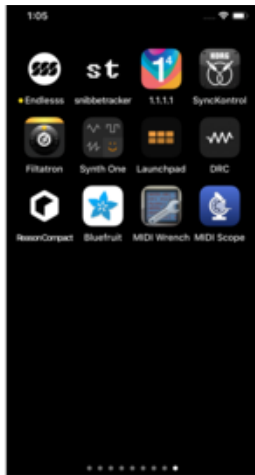

## Install Bluefruit LE

The first step is to install the app on your device.

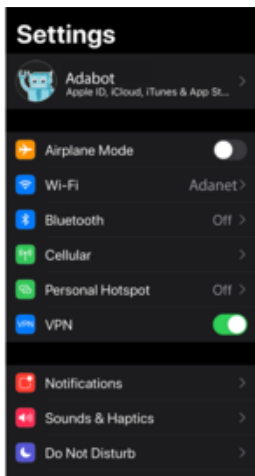

## Enable Bluetooth

If Bluetooth is disabled on your device, enable it by going to Setting > Bluetooth on your iOS device and then turning it on.

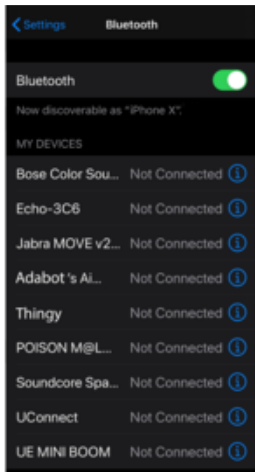

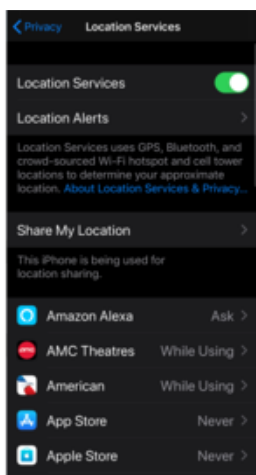
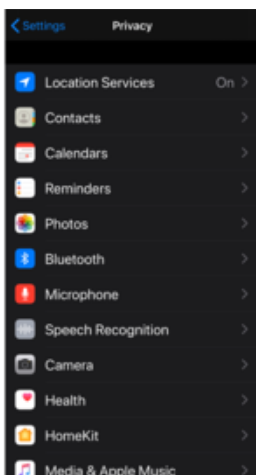
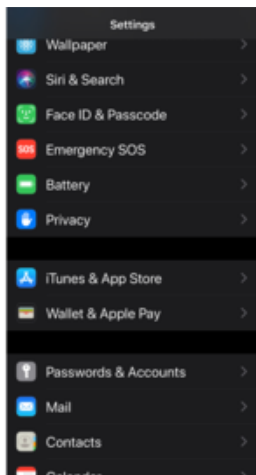

## Enable Location Services

If you plan to use the app to send location/GPS data to Bluefruit LE, enable Location Services. Enable it on iOS using Settings->Privacy->Location Services.

## Scan for Devices

Launch the app now -- it will automatically begin to scan the airwaves for Bluetooth LE devices. These are presented in a list at the bottom of the page.

Notice, you can use the Must have UART Service filter to prevent BLE devices from showing up that can't work with the app.

- To refresh the list and start a new scan, simply swipe down on the current list.

- Each device's signal strength is displayed in the left side of its row.

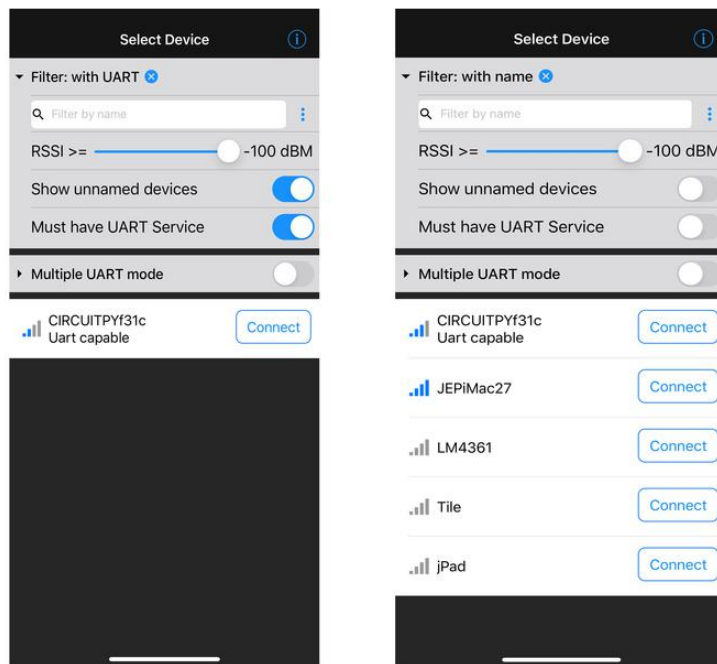

If you tap on the device entry (not on Connect), you'll see more detail about a particular device:

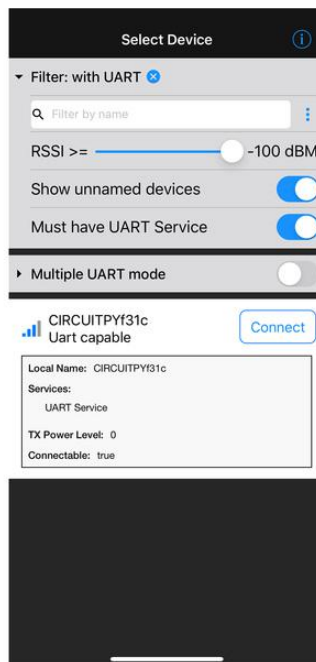

## Connect

Tap the Connect button on the UART capable device you wish to use. The app will connect to the Circuit Playground Bluefruit! Now, you'll be presented with the Device name and signal strength, and a number of different Modules you can use.

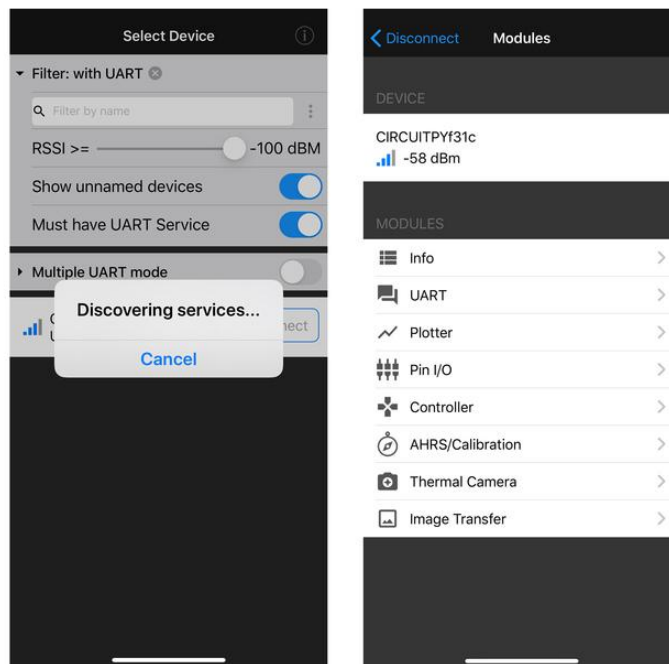

## Controller Module

Click on the Controller module. You'll see a number of different sensor data streaming options. Enabling these will allow you to send data from your phone, such as the Accelerometer data or Location data, directly to your Circuit Playground Bluefruit!

The two modules on this page that can send data to the Circuit Playground Bluefruit are the Control Pad and Color Picker.

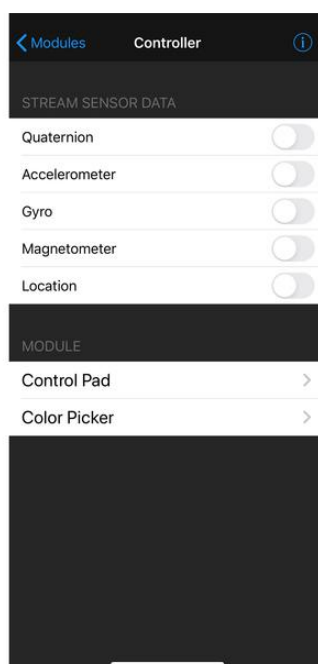

# Color Picker

Click on the Color Picker. Now, you can dial in the hue, saturation, and value of a color using the color wheel and value slider.

[Follow this page \(\)](#) for setting up the CPB with the color picker code.

Press the Send selected color button and your color values will be sent to the Circuit Playground Bluefruit to adjust its NeoPixels!

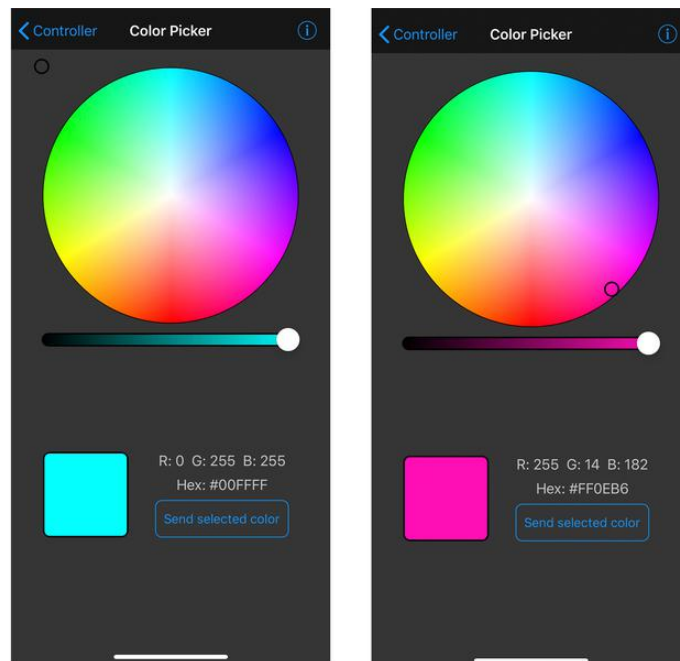

The app provides many other features with the additional modules. Have a look at the [Bluefruit LE Connect for iOS and Android standalone guide \(\)](#) for an explanation of each feature.

---

## Downloads

### Files:

- [Datasheet for Nordic nRF52840 \(\)](#)
- [Nordic InfoCenter for further documentation \(\)](#)
- [EagleCAD files for Circuit Playground Bluefruit on GitHub \(\)](#)
- [3D Models on GitHub \(\)](#)
- [Fritzing object in the Adafruit Fritzing Library \(\)](#)
- [PDF for Circuit Playground Bluefruit PrettyPins Pinout Diagram \(\)](#)

## SVG for Circuit Playground Bluefruit PrettyPins Pinout Diagram

To download the original Circuit Playground Bluefruit sketch that shipped on your CPB, click the button below.

CPBLUEFRUIT.UF2

## Schematic for Circuit Playground Bluefruit

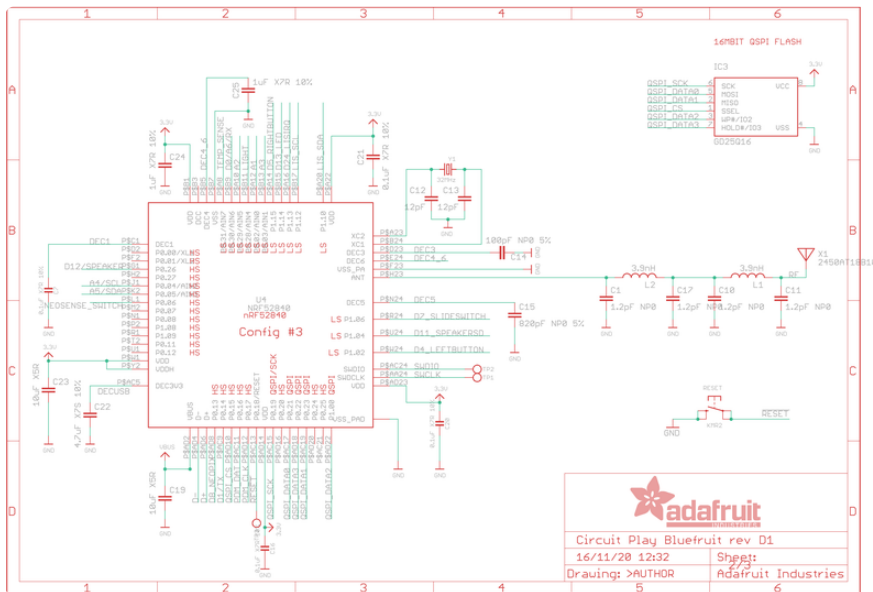
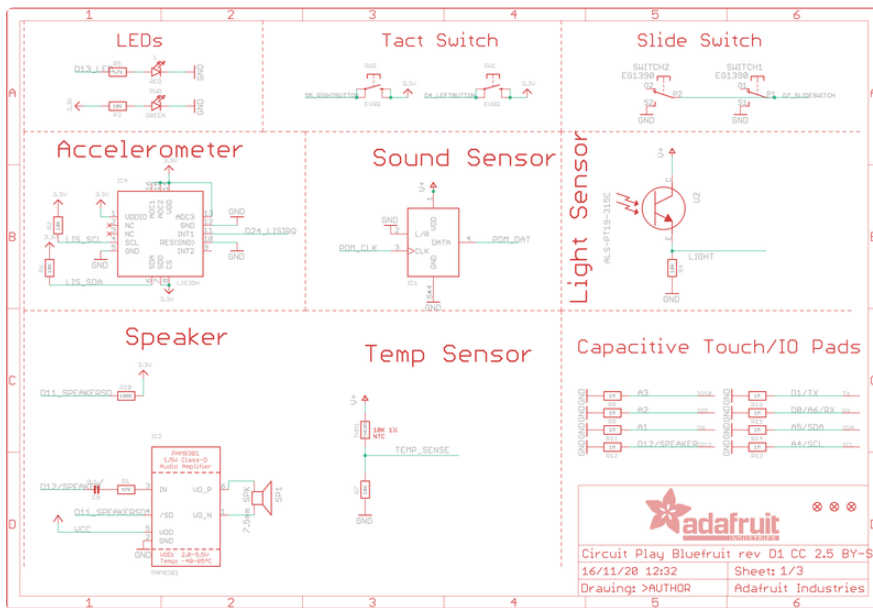

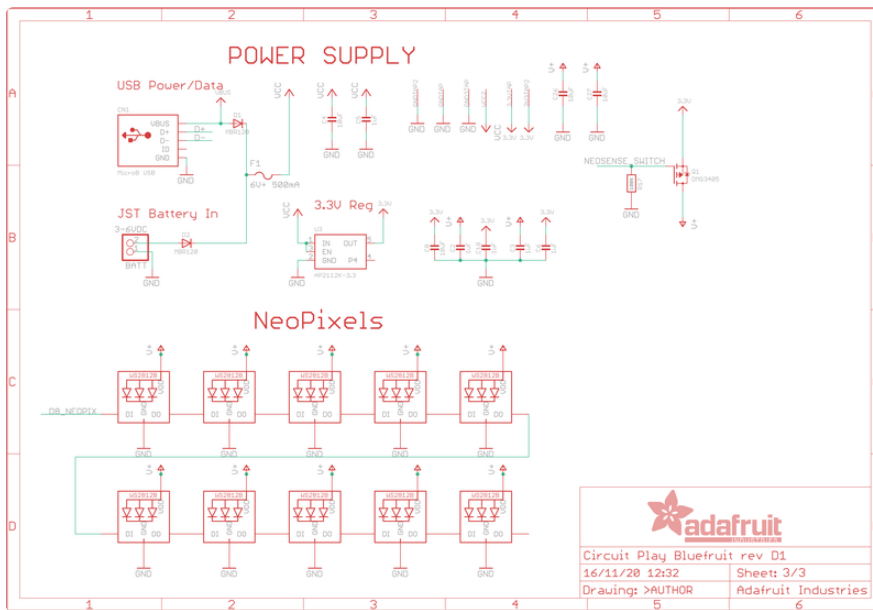

# Fab print of Circuit Playground Bluefruit

